

# Keysight U2600A Series USB Isolated Digital Input/Output Modules



NOTICE: This document contains references to Agilent Technologies. Agilent's former Test and Measurement business has become Keysight Technologies. For more information, go to [www.keysight.com](http://www.keysight.com).



# Notices

## Copyright Notice

© Keysight Technologies 2007-2017

No part of this manual may be reproduced in any form or by any means (including electronic storage and retrieval or translation into a foreign language) without prior agreement and written consent from Keysight Technologies as governed by United States and international copyright laws.

## Trademarks

Pentium is a U.S. registered trademark of Intel Corporation.

Microsoft, Visual Studio, Windows, and MS Windows are trademarks of Microsoft Corporation in the United States and or other countries.

## Manual Part Number

U2651-90011

## Edition

Edition 7, June 1, 2017

## Printed in:

Printed in Malaysia

## Published by:

Keysight Technologies  
Bayan Lepas Free Industrial Zone,  
11900 Penang, Malaysia

## Technology Licenses

The hardware and/or software described in this document are furnished under a license and may be used or copied only in accordance with the terms of such license.

## Declaration of Conformity

Declarations of Conformity for this product and for other Keysight products may be downloaded from the Web. Go to <http://www.keysight.com/go/conformity>. You can then search by product number to find the latest Declaration of Conformity.

## U.S. Government Rights

The Software is “commercial computer software,” as defined by Federal Acquisition Regulation (“FAR”) 2.101. Pursuant to FAR 12.212 and 27.405-3 and Department of Defense FAR Supplement (“DFARS”) 227.7202, the U.S. government acquires commercial computer software under the same terms by which the software is customarily provided to the public. Accordingly, Keysight provides the Software to U.S. government customers under its standard commercial license, which is embodied in its End User License Agreement (EULA), a copy of which can be found at <http://www.keysight.com/find/sweula>. The license set forth in the EULA represents the exclusive authority by which the U.S. government may use, modify, distribute, or disclose the Software. The EULA and the license set forth therein, does not require or permit, among other things, that Keysight: (1) Furnish technical information related to commercial computer software or commercial computer software documentation that is not customarily provided to the public; or (2) Relinquish to, or otherwise provide, the government rights in excess of these rights customarily provided to the public to use, modify, reproduce, release, perform, display, or disclose commercial computer software or commercial computer software documentation. No additional government requirements beyond those set forth in the EULA shall apply, except to the extent that those terms, rights, or licenses are explicitly required from all providers of commercial computer software pursuant to the FAR and the DFARS and are set forth specifically in writing elsewhere in the EULA. Keysight shall be under no obligation to update, revise or otherwise modify the Software. With respect to any technical data as defined by FAR 2.101, pursuant to FAR 12.211 and 27.404.2 and DFARS 227.7102, the U.S. government acquires no greater than Limited Rights as defined in FAR 27.401 or DFAR 227.7103-5 (c), as applicable in any technical data.

## Warranty

THE MATERIAL CONTAINED IN THIS DOCUMENT IS PROVIDED “AS IS,” AND IS SUBJECT TO BEING CHANGED, WITHOUT NOTICE, IN FUTURE EDITIONS. FURTHER, TO THE MAXIMUM EXTENT PERMITTED BY APPLICABLE LAW, KEYSIGHT DISCLAIMS ALL WARRANTIES, EITHER EXPRESS OR IMPLIED, WITH REGARD TO THIS MANUAL AND ANY INFORMATION CONTAINED HEREIN, INCLUDING BUT NOT LIMITED TO THE IMPLIED WARRANTIES OF MERCHANTABILITY AND FITNESS FOR A PARTICULAR PURPOSE. KEYSIGHT SHALL NOT BE LIABLE FOR ERRORS OR FOR INCIDENTAL OR CONSEQUENTIAL DAMAGES IN CONNECTION WITH THE FURNISHING, USE, OR PERFORMANCE OF THIS DOCUMENT OR OF ANY INFORMATION CONTAINED HEREIN. SHOULD KEYSIGHT AND THE USER HAVE A SEPARATE WRITTEN AGREEMENT WITH WARRANTY TERMS COVERING THE MATERIAL IN THIS DOCUMENT THAT CONFLICT WITH THESE TERMS, THE WARRANTY TERMS IN THE SEPARATE AGREEMENT SHALL CONTROL.

## Safety Information

### CAUTION

















A CAUTION notice denotes a hazard. It calls attention to an operating procedure, practice, or the like that, if not correctly performed or adhered to, could result in damage to the product or loss of important data. Do not proceed beyond a CAUTION notice until the indicated conditions are fully understood and met.

### WARNING

A WARNING notice denotes a hazard. It calls attention to an operating procedure, practice, or the like that, if not correctly performed or adhered to, could result in personal injury or death. Do not proceed beyond a WARNING notice until the indicated conditions are fully understood and met.

## Safety Symbols

The following symbols on the instrument and in the documentation indicate precautions which must be taken to maintain safe operation of the instrument.

	Direct current (DC)		Equipment protected throughout by double insulation or reinforced insulation
	Alternating current (AC)		Off (power supply)
	Both direct and alternating current		On (power supply)
	Three-phase alternating current		Caution, risk of electric shock
	Earth (ground) terminal		Caution, risk of danger (refer to this manual for specific Warning or Caution information)
	Protective conductor terminal		Caution, hot surface
	Frame or chassis terminal		Out position of a bi-stable push control
	Equipotentiality		In position of a bi-stable push control

## General Safety Information

### WARNING

- Do not use the device if it is damaged. Before you use the device, inspect the case. Look for cracks or missing plastic. Do not operate the device around explosive gas, vapor or dust.
  - Do not apply more than the rated voltage (as marked on the device) between terminals, or between terminal and external ground.
  - Always use the device with the cables provided.
  - Observe all markings on the device before connecting to the device.
  - Turn off the device and application system power before connecting to the I/O terminals.
  - When servicing the device, use only the specified replacement parts. Do not operate the device with the removable cover removed or loosened.
  - Do not connect any cables and terminal block prior to performing the self-test process.
  - Use only the power adapter supplied by the manufacturer to avoid any unexpected hazards.
- 

### CAUTION

- Do not load the output terminals above the specified current limits. Applying excessive voltage or overloading the device will cause irreversible damage to the circuitry.
  - Applying excessive voltage or overloading the input terminal will damage the device permanently.
  - If the device is used in a manner not specified by the manufacturer, the protection provided by the device may be impaired.
  - Always use dry cloth to clean the device. Do not use ethyl alcohol or any other volatile liquid to clean the device.
  - Do not permit any blockage of the ventilation holes of the device.
-

## Environmental Conditions

This instrument is designed for indoor use and in an area with low condensation. The table below shows the general environmental requirements for this instrument.

Environmental conditions	Requirements
Operating temperature	0 °C to +55 °C
Operating humidity	15% to 85% RH non-condensing
Storage temperature	-20 °C to 70 °C

### NOTE

The U2600A Series USB Isolated Digital Input/Output Modules complies with the following safety and EMC requirements.

- IEC 61010-1:2001/EN 61010-1:2001
- Canada: CAN/CSA-C22.2 No.61010-1-04
- USA: ANSI/UL 61010-1: 2004
- IEC 61326-1:2002/EN 61326-1:1997+A1:1998+A2:2001+A3:2003
- CISPR 11: 1990/EN55011:1990 – Group 1 Class A
- Canada: ICES-001: 2004
- Australia/New Zealand: AS/NZS CISPR11:2004

## Regulatory Markings

	<p>The CE mark is a registered trademark of the European Community. This CE mark shows that the product complies with all the relevant European Legal Directives.</p>		<p>ICES/NMB-001 indicates that this ISM device complies with the Canadian ICES-001. Cet appareil ISM est conforme a la norme NMB-001 du Canada.</p>
<p><b>ICES/NMB-001</b></p>	<p>The RCM mark is a registered trademark of the Australian Communications and Media Authority.</p>		<p>The CSA mark is a registered trademark of the Canadian Standards Association.</p>



## Waste Electrical and Electronic Equipment (WEEE) Directive 2002/96/EC

This instrument complies with the WEEE Directive (2002/96/EC) marking requirement. This affixed product label indicates that you must not discard this electrical or electronic product in domestic household waste.

### Product category:

With reference to the equipment types in the WEEE directive Annex 1, this instrument is classified as a “Monitoring and Control Instrument” product.

The affixed product label is as shown below.



Do not dispose in domestic household waste.

To return this unwanted instrument, contact your nearest Keysight Service Center, or visit <http://about.keysight.com/en/companyinfo/environment/takeback.shtml> for more information.

## Sales and Technical Support

To contact Keysight for sales and technical support, refer to the support links on the following Keysight websites:

- [www.keysight.com/find/U2600A](http://www.keysight.com/find/U2600A)  
(product-specific information and support, software and documentation updates)
- [www.keysight.com/find/assist](http://www.keysight.com/find/assist)  
(worldwide contact information for repair and service)

THIS PAGE HAS BEEN INTENTIONALLY LEFT BLANK.

# Table of Contents

Safety Symbols	5
General Safety Information	6
Environmental Conditions	7
Regulatory Markings	8
Waste Electrical and Electronic Equipment (WEEE) Directive	
2002/96/EC	9
Product category:	9
Sales and Technical Support	9
<b>1 Getting Started</b>	
Introduction	18
Product Overview	19
Product outlook	19
Product dimension	20
Terminal Block Overview	21
Standard Purchase Items Checklist	22
Software Installation	23
L-Mount Kit Installation	24
General Maintenance	26
Additional Information	27
Hardware verification	27
Sample code	29
<b>2 Connector Pins Configuration</b>	
Introduction	32
Connector Pins Configuration for U2651A	33
Connector Pins Configuration for U2652A	35
Connector Pins Configuration for U2653A	37
55-pin Connector (J1) Pins Configuration	39

<b>3</b>	<b>Features and Functions</b>	
	Digital Input/Output	42
	Isolated digital input channels	43
	Isolated digital output channels	44
	Virtual Port Group Function	47
	Interrupt Function	49
	Trigger Function	53
<b>4</b>	<b>Characteristics and Specifications</b>	
<b>5</b>	<b>Dismantle Procedures</b>	
	General Disassemble	66
	Mechanical disassemble	66
	Troubleshooting	70
	Self-Test Procedures	71

## List of Figures

Figure 2-1	Connector in vertical view	32
Figure 2-2	Connector in horizontal view	32
Figure 2-3	Pins configuration for U2651A	33
Figure 2-4	Pins configuration for U2652A	35
Figure 2-5	Pins configuration for U2653A	37
Figure 2-6	Connector (J1) 55-pin	39
Figure 3-1	Isolated digital input bit through a photo coupler	43
Figure 3-2	The maximum and minimum allowable input voltage at $DI_{in}$ and $DI_{COM}$ and the absolute voltage range for DIO to see a logic high	43
Figure 3-3	Isolated digital output is switched on with load	45
Figure 3-4	Isolated digital output is switched off with load	45
Figure 3-5	Enabling the Interrupt Operation Register will allow it to send a signal, "1" to the Status Byte Register when either the logic level for bit 301 or bit 302 changes from "0" to "1".	49
Figure 3-6	Flowchart for interrupt function operation	51
Figure 3-7	Flowchart for trigger function operation	53

THIS PAGE HAS BEEN INTENTIONALLY LEFT BLANK.

## List of Tables

Table 2-1	Pins legend for U2651A	34
Table 2-2	Pins legend for U2652A	36
Table 2-3	Pins legend for U2653A	38
Table 2-4	U2600A series J1 connector pin assignment	39
Table 2-5	U2600A series J1 connector legend	40
Table 3-1	Step-by-step descriptions for trigger function flowchart	54

THIS PAGE HAS BEEN INTENTIONALLY LEFT BLANK.



# 1 Getting Started

Introduction	18
Product Overview	19
Terminal Block Overview	21
Standard Purchase Items Checklist	22
Software Installation	23
L-Mount Kit Installation	24
General Maintenance	26
Additional Information	27

This chapter contains instructions on how to get started with U2600A Series USB isolated digital input/output modules that begins from system requirements checking, to installations of hardware and software, and to the launching of the Keysight Measurement Manager application software.

## Introduction

The U2600A Series USB isolated digital input/output modules (DIO) consists of three models:

- U2651A: Isolated 32-bit DI and 32-bit DO
- U2652A: Isolated 64-bit DI
- U2653A: Isolated 64-bit DO

These series can be used as a standalone unit or as a modular unit. However, if used as a modular unit, the module needs to be installed into the U2781A USB Modular Instrument Chassis.

All three models are high performance modules with up to eight channels. High digital I/O lines increases the utility of the product and offers you added flexibility.

The U2600A Series USB isolated DIO modules recognizes a wide range of digital input (10 V to 24 V) as logic high. This provides you with more choices when choosing external sensors with different DC output levels. The U2600A Series modules are also equipped with a high voltage isolation protection of up to 1250 Vrms to prevent the internal circuits from severe damage.

In addition, these modules are capable of driving most actuators in industrial automation applications with a high output driving capability of up to 35 V. The U2600A Series USB isolated DIO modules also offer a wide range of compatibility with Application Development Environments (ADE) such as Keysight VEE, LabVIEW, MATLAB, and Microsoft Visual Studio.

The U2600A Series USB isolated DIO modules are user friendly modules as setting up is quick and easy with the Hi-speed USB connection interface (up to 480 Mb/s). Moreover, the modules are bundled with the Keysight Measurement Manager application software for ease of management.

# Product Overview

## Product outlook

### Front View

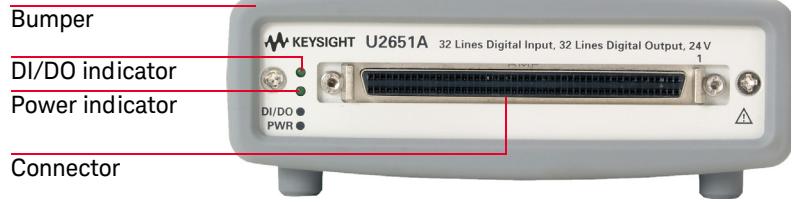

### Rear View

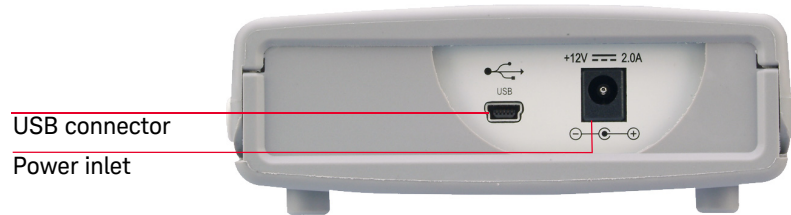

### Top view

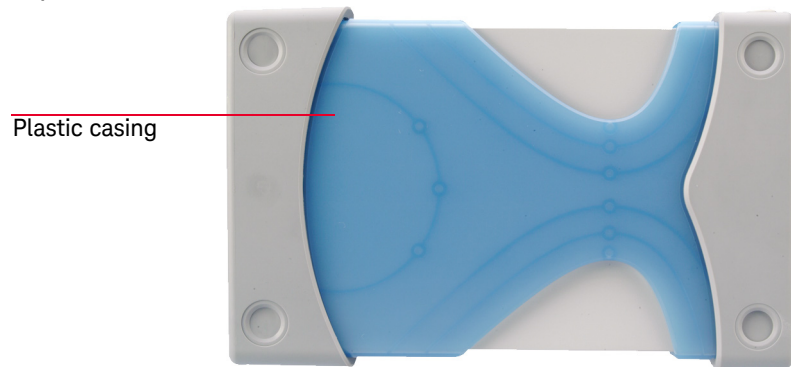

## Product dimension

With plastic casing

Top view

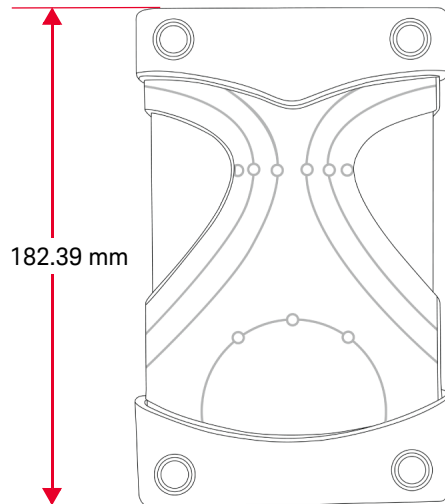

Front view

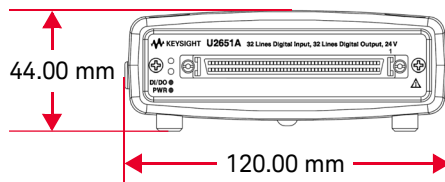

Without plastic casing

Top view

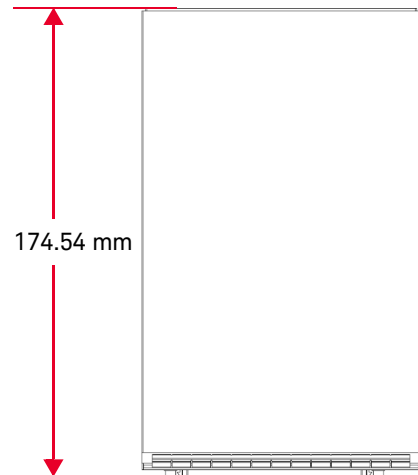

Front view

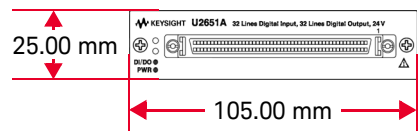

# Terminal Block Overview

Top view

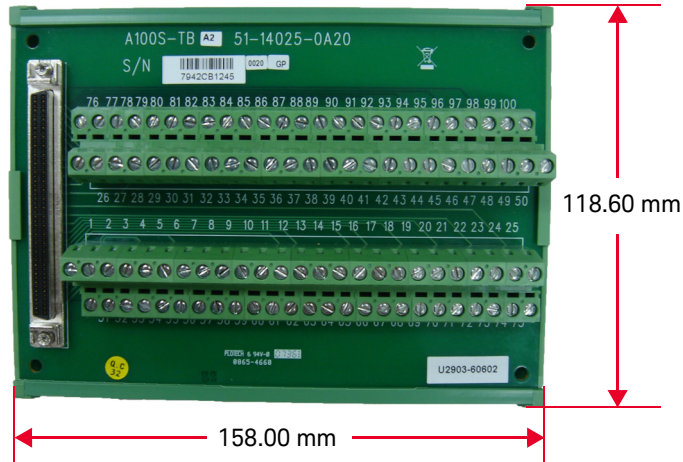

Side View

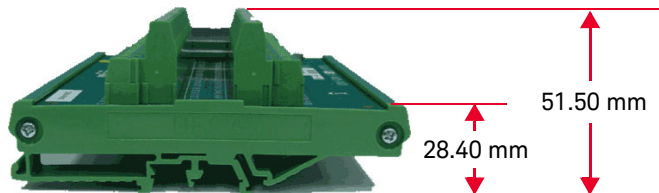

## Standard Purchase Items Checklist

Inspect and verify that you have all the following items upon your standard purchase of the U2600A Series USB isolated DIO modules. If there are missing items, please contact the nearest Keysight Sales Office.

- ✓ DC power adapter
- ✓ Power cord
- ✓ USB extension cable
- ✓ L-Mount kit (used with the Keysight U2781A modular instrument chassis)
- ✓ Keysight USB Modular Products and Systems Quick Start Guide
- ✓ Keysight USB Modular Products and Systems Product Reference DVD-ROM
- ✓ Keysight Automation-Ready CD-ROM (contains the Keysight IO Libraries Suite)
- ✓ Certificate of Calibration

### **WARNING**

Use only power adaptor provided by manufacturer to avoid unexpected hazard.

---

## Software Installation

If you would like to use the U2600A Series USB isolated DIO modules with the Keysight Measurement Manager application software, follow the step-by-step instructions as shown in the *Keysight USB Modular Products and Systems Quick Start Guide*.

**NOTE**

You may require to install IVI-COM driver before using the U2600A Series USB isolated DIO modules with other ADEs.

---

## L-Mount Kit Installation

The L-Mount kit is to be used with Keysight U2781A USB modular instrument chassis. The following instructions describe simple procedures of installing the L-Mount kit to a U2600A Series USB isolated DIO modules.

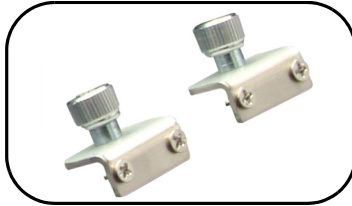

**1** Unpack the L-Mount kit from the packaging.

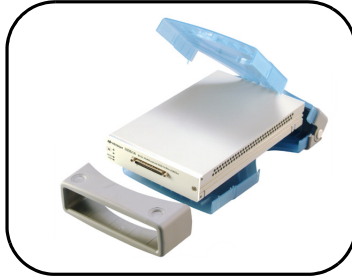

**2** Remove your USB device from its plastic casing by pulling the bumper (front end of the casing) outward direction. Then, lift the plastic body casing and remove it from your USB device.

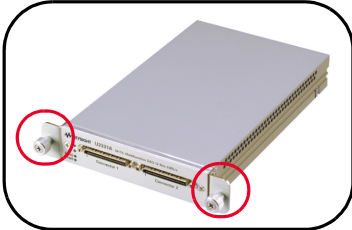

**3** Using the *Philip* screw driver, screw the L-Mount kit to your USB device.



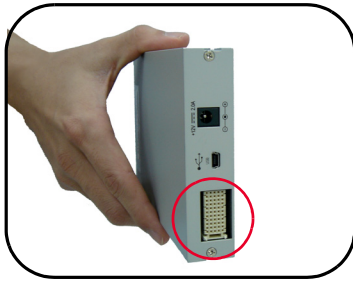

**4** To slot in the USB module to your chassis, turn your module perpendicularly and ensure that the 55-pin backplane connector is at the bottom side of the USB module.



**5** Your USB module is now ready to be plug into an instrument chassis.

## General Maintenance

**NOTE**

Repair or service which are not covered in this manual should only be performed by qualified personnel.

---

To remove the dirt or moisture the USB device, follow the instructions below.

- 1** Power off the USB device and remove the AC/DC adapter cord and USB cable from your device.
- 2** Remove your USB device from its plastic casing by pulling at the bumper (front end of the casing) outward direction. Then, lift the plastic body casing and remove it from your USB device.
- 3** Holding your USB device, shake out any dirt that may have accumulated on the panel of your USB device.
- 4** Wipe your USB device with a dry clean cloth.

## Additional Information

### Hardware verification

Keysight Connection Expert is one of the utilities of Keysight IO Libraries. It can automatically detect the USB devices that were connected to the PC and enables the communication between the USB device and the PC. To verify that your USB device has established a connection with your PC, do the following steps.

- 1 Go to **Start > All Programs > Keysight IO Libraries Suite > Keysight Connection Expert** to launch the Keysight Connection Expert.
- 2 The connected USB device will be visible in the **Instrument I/O on this PC** panel as indicated in the following. Select the DIO connection interface and right-click.

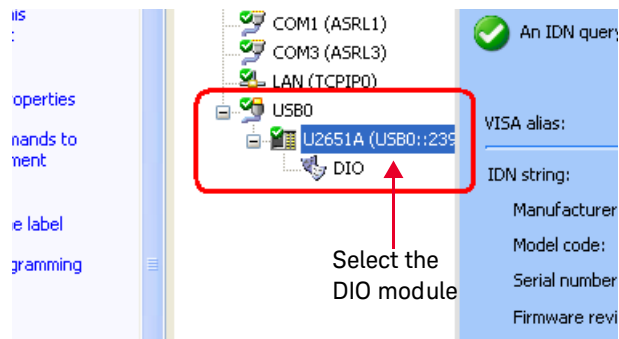

## 1 Getting Started

- 3 A context menu will appear. Click **Send Commands To This Instrument**. The Keysight Interactive IO dialog box will appear as shown below. Click **Send & Read** to send the **\*IDN?** default SCPI command. The instrument's response will be displayed in the **Instrument Session History** panel.

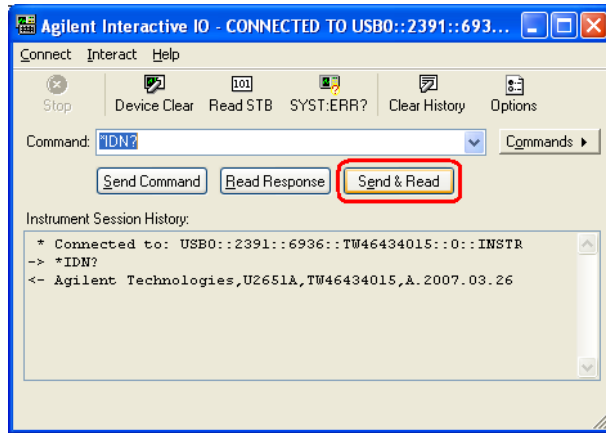

- 4 Successful communication between the PC and the connected hardware indicate successful hardware installation and connection establishment.

## Sample code

Sample codes for Keysight VEE, LabView and Microsoft (C#, C++, VB7 and VB6) are provided to help you get started and familiarized with the instrument. The sample codes provided for each language are as follows.

- **Example1:** Demonstrates the initialization of the instrument
- **ReadWriteChannel:** Read data from instrument and write data to instrument
- **Interrupt:** Demonstrates how the interrupt function works
- **Trigger:** Demonstrates how the trigger function works. An error will be shown if user tries to write the value after the trigger has been executed.
- **Custom channel:** User can group eight DI bits to form a new DI channel or group eight DO bits to form a new DO channel. The new DI or DO channels can then be used to perform normal DIO operation.

### To view the sample code

Select **Sample Code** on the Keysight Modular Products Installation Menu and choose the type of language. See the following figure.

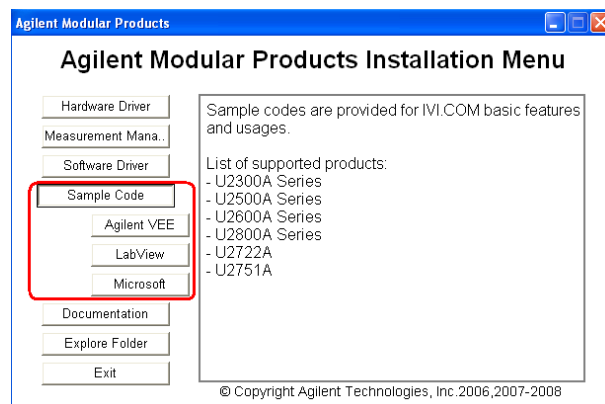

THIS PAGE HAS BEEN INTENTIONALLY LEFT BLANK.

# 2 Connector Pins Configuration

Introduction	32
Connector Pins Configuration for U2651A	33
Connector Pins Configuration for U2652A	35
Connector Pins Configuration for U2653A	37
55-pin Connector (J1) Pins Configuration	39

This chapter describes the U2600A Series USB isolated digital input/output modules pins configuration and the theory operation of isolated DIO.

## Introduction

The U2600A Series USB isolated digital input/output modules were equipped with 100-pin SCSI-II connector. The connector pins configuration for all of the U2600A Series USB isolated DIO modules are provided in this chapter. When the DIO module is used in a modular instrument chassis (U2781A), see [Figure 2-1](#) for the pins numbering. When the DIO module is used as a standalone unit, see [Figure 2-2](#).

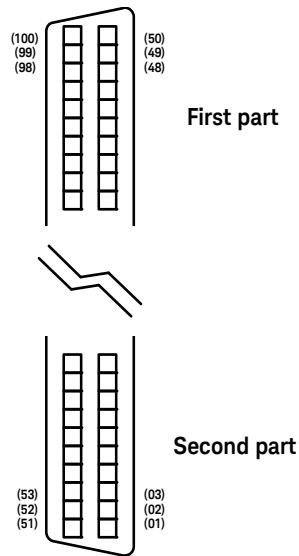

**Figure 2-1** Connector in vertical view

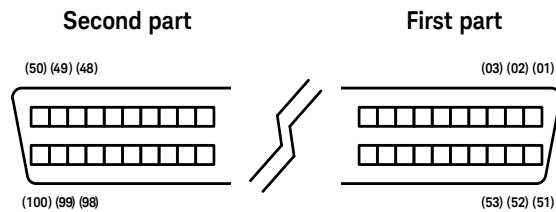

**Figure 2-2** Connector in horizontal view



## Connector Pins Configuration for U2651A

First Part			Second Part				
DI_101.0/301	<b>1</b>	<b>51</b>	DI_102.0	<b>26</b>	<b>76</b>	DO_202.0	
DI_101.1/302	<b>2</b>	<b>52</b>	DI_102.1	<b>27</b>	<b>77</b>	DO_202.1	
DI_101.2	<b>3</b>	<b>53</b>	DI_102.2	<b>28</b>	<b>78</b>	DO_202.2	
DI_101.3	<b>4</b>	<b>54</b>	DI_102.3	<b>29</b>	<b>79</b>	DO_202.3	
DI_101.4	<b>5</b>	<b>55</b>	DI_102.4	<b>30</b>	<b>80</b>	DO_202.4	
DI_101.5	<b>6</b>	<b>56</b>	DI_102.5	<b>31</b>	<b>81</b>	DO_202.5	
DI_101.6	<b>7</b>	<b>57</b>	DI_102.6	<b>32</b>	<b>82</b>	DO_202.6	
DI_101.7	<b>8</b>	<b>58</b>	DI_102.7	<b>33</b>	<b>83</b>	DO_202.7	
COM_101	<b>9</b>	<b>59</b>	COM_102	<b>34</b>	<b>84</b>	VDD_202	
COM_101	<b>10</b>	<b>60</b>	COM_102	<b>DO_GND</b>	<b>35</b>	<b>85</b>	DO_GND
COM_101	<b>11</b>	<b>61</b>	COM_102	<b>DO_GND</b>	<b>36</b>	<b>86</b>	DO_GND
COM_101	<b>12</b>	<b>62</b>	COM_102	<b>DO_GND</b>	<b>37</b>	<b>87</b>	DO_GND
DI_103.0	<b>13</b>	<b>63</b>	DI_104.0	<b>DO_203.0</b>	<b>38</b>	<b>88</b>	DO_204.0
DI_103.1	<b>14</b>	<b>64</b>	DI_104.1	<b>DO_203.1</b>	<b>39</b>	<b>89</b>	DO_204.1
DI_103.2	<b>15</b>	<b>65</b>	DI_104.2	<b>DO_203.2</b>	<b>40</b>	<b>90</b>	DO_204.2
DI_103.3	<b>16</b>	<b>66</b>	DI_104.3	<b>DO_203.3</b>	<b>41</b>	<b>91</b>	DO_204.3
DI_103.4	<b>17</b>	<b>67</b>	DI_104.4	<b>DO_203.4</b>	<b>42</b>	<b>92</b>	DO_204.4
DI_103.5	<b>18</b>	<b>68</b>	DI_104.5	<b>DO_203.5</b>	<b>43</b>	<b>93</b>	DO_204.5
DI_103.6	<b>19</b>	<b>69</b>	DI_104.6	<b>DO_203.6</b>	<b>44</b>	<b>94</b>	DO_204.6
DI_103.7	<b>20</b>	<b>70</b>	DI_104.7	<b>DO_203.7</b>	<b>45</b>	<b>95</b>	DO_204.7
COM_103	<b>21</b>	<b>71</b>	COM_104	<b>VDD_203</b>	<b>46</b>	<b>96</b>	VDD_204
COM_103	<b>22</b>	<b>72</b>	COM_104	<b>DO_GND</b>	<b>47</b>	<b>97</b>	DO_GND
COM_103	<b>23</b>	<b>73</b>	COM_104	<b>DO_GND</b>	<b>48</b>	<b>98</b>	DO_GND
COM_103	<b>24</b>	<b>74</b>	COM_104	<b>DO_GND</b>	<b>49</b>	<b>99</b>	DO_GND
NC	<b>25</b>	<b>75</b>	NC	<b>+5 V</b>	<b>50</b>	<b>100</b>	+5 V

Figure 2-3 Pins configuration for U2651A

**Table 2-1** Pins legend for U2651A

Pin	Descriptions
DI_10n.0...7	Isolated digital input channel “n” and bit 0 to 7; n = 1, 2, 3, 4
DO_20n.0...7	Isolated digital output channel “n” and bit 0 to 7; n = 1, 2, 3, 4
COM_101	Common junction for input channel 1
COM_102	Common junction for input channel 2
COM_103	Common junction for input channel 3
COM_104	Common junction for input channel 4
VDD_201	VDD pin for output channel 1
VDD_202	VDD pin for output channel 2
VDD_203	VDD pin for output channel 3
VDD_204	VDD pin for output channel 4
DO_GND	Ground return path of isolated channels
+5 V	On board +5 V regulated power supply
NC	No connection

## Connector Pins Configuration for U2652A

First Part			Second Part				
DI_101.0/301	<b>1</b>	<b>51</b>	DI_102.0	DI_105.0	<b>26</b>	<b>76</b>	DI_106.0
DI_101.1/302	<b>2</b>	<b>52</b>	DI_102.1	DI_105.1	<b>27</b>	<b>77</b>	DI_106.1
DI_101.2	<b>3</b>	<b>53</b>	DI_102.2	DI_105.2	<b>28</b>	<b>78</b>	DI_106.2
DI_101.3	<b>4</b>	<b>54</b>	DI_102.3	DI_105.3	<b>29</b>	<b>79</b>	DI_106.3
DI_101.4	<b>5</b>	<b>55</b>	DI_102.4	DI_105.4	<b>30</b>	<b>80</b>	DI_106.4
DI_101.5	<b>6</b>	<b>56</b>	DI_102.5	DI_105.5	<b>31</b>	<b>81</b>	DI_106.5
DI_101.6	<b>7</b>	<b>57</b>	DI_102.6	DI_105.6	<b>32</b>	<b>82</b>	DI_106.6
DI_101.7	<b>8</b>	<b>58</b>	DI_102.7	DI_105.7	<b>33</b>	<b>83</b>	DI_106.7
COM_101	<b>9</b>	<b>59</b>	COM_102	COM_105	<b>34</b>	<b>84</b>	COM_106
COM_101	<b>10</b>	<b>60</b>	COM_102	COM_105	<b>35</b>	<b>85</b>	COM_106
COM_101	<b>11</b>	<b>61</b>	COM_102	COM_105	<b>36</b>	<b>86</b>	COM_106
COM_101	<b>12</b>	<b>62</b>	COM_102	COM_105	<b>37</b>	<b>87</b>	COM_106
DI_103.0	<b>13</b>	<b>63</b>	DI_104.0	DI_107.0	<b>38</b>	<b>88</b>	DI_108.0
DI_103.1	<b>14</b>	<b>64</b>	DI_104.1	DI_107.1	<b>39</b>	<b>89</b>	DI_108.1
DI_103.2	<b>15</b>	<b>65</b>	DI_104.2	DI_107.2	<b>40</b>	<b>90</b>	DI_108.2
DI_103.3	<b>16</b>	<b>66</b>	DI_104.3	DI_107.3	<b>41</b>	<b>91</b>	DI_108.3
DI_103.4	<b>17</b>	<b>67</b>	DI_104.4	DI_107.4	<b>42</b>	<b>92</b>	DI_108.4
DI_103.5	<b>18</b>	<b>68</b>	DI_104.5	DI_107.5	<b>43</b>	<b>93</b>	DI_108.5
DI_103.6	<b>19</b>	<b>69</b>	DI_104.6	DI_107.6	<b>44</b>	<b>94</b>	DI_108.6
DI_103.7	<b>20</b>	<b>70</b>	DI_104.7	DI_107.7	<b>45</b>	<b>95</b>	DI_108.7
COM_103	<b>21</b>	<b>71</b>	COM_104	COM_107	<b>46</b>	<b>96</b>	COM_108
COM_103	<b>22</b>	<b>72</b>	COM_104	COM_107	<b>47</b>	<b>97</b>	COM_108
COM_103	<b>23</b>	<b>73</b>	COM_104	COM_107	<b>48</b>	<b>98</b>	COM_108
COM_103	<b>24</b>	<b>74</b>	COM_104	COM_107	<b>49</b>	<b>99</b>	COM_108
NC	<b>25</b>	<b>75</b>	NC	NC	<b>50</b>	<b>100</b>	NC

**Figure 2-4** Pins configuration for U2652A

**Table 2-2** Pins legend for U2652A

Pin	Descriptions
DI_10n.0...7	Isolated digital input channel “n” and bit 0 to 7; n = 1 to 8
COM_101	Common junction for input channel 1
COM_102	Common junction for input channel 2
COM_103	Common junction for input channel 3
COM_104	Common junction for input channel 4
COM_105	Common junction for input channel 5
COM_106	Common junction for input channel 6
COM_107	Common junction for input channel 7
COM_108	Common junction for input channel 8
NC	No connection

## Connector Pins Configuration for U2653A

First Part			Second Part				
DO_201.0	1	51	DO_202.0	26	76	DO_206.0	
DO_201.1	2	52	DO_202.1	27	77	DO_206.1	
DO_201.2	3	53	DO_202.2	28	78	DO_206.2	
DO_201.3	4	54	DO_202.3	29	79	DO_206.3	
DO_201.4	5	55	DO_202.4	30	80	DO_206.4	
DO_201.5	6	56	DO_202.5	31	81	DO_206.5	
DO_201.6	7	57	DO_202.6	32	82	DO_206.6	
DO_201.7	8	58	DO_202.7	33	83	DO_206.7	
VDD_201	9	59	VDD_202	34	84	VDD_206	
DO_GND	10	60	DO_GND	35	85	DO_GND	
DO_GND	11	61	DO_GND	36	86	DO_GND	
DO_GND	12	62	DO_GND	37	87	DO_GND	
DO_203.0	13	63	DO_204.0	38	88	DO_208.0	
DO_203.1	14	64	DO_204.1	39	89	DO_208.1	
DO_203.2	15	65	DO_204.2	40	90	DO_208.2	
DO_203.3	16	66	DO_204.3	41	91	DO_208.3	
DO_203.4	17	67	DO_204.4	42	92	DO_208.4	
DO_203.5	18	68	DO_204.5	43	93	DO_208.5	
DO_203.6	19	69	DO_204.6	44	94	DO_208.6	
DO_203.7	20	70	DO_204.7	45	95	DO_208.7	
VDD_203	21	71	VDD_204	46	96	VDD_208	
DO_GND	22	72	DO_GND	47	97	DO_GND	
DO_GND	23	73	DO_GND	48	98	DO_GND	
DO_GND	24	74	DO_GND	49	99	DO_GND	
NC	25	75	NC	+5 V	50	100	+5 V

Figure 2-5 Pins configuration for U2653A

**Table 2-3** Pins legend for U2653A

Pin	Descriptions
DO_20n.0...7	Isolated digital output channel “n” and bit 0 to 7; n = 1 to 8
VDD_201	VDD pin for output channel 1
VDD_202	VDD pin for output channel 2
VDD_203	VDD pin for output channel 3
VDD_204	VDD pin for output channel 4
VDD_205	VDD pin for output channel 5
VDD_206	VDD pin for output channel 6
VDD_207	VDD pin for output channel 7
VDD_208	VDD pin for output channel 8
DO_GND	Ground return path of isolated channels
+5 V	On board +5 V regulated power supply
NC	No connection

## 55-pin Connector (J1) Pins Configuration

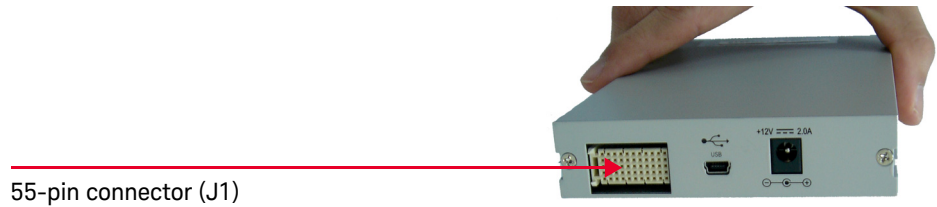

**Figure 2-6** Connector (J1) 55-pin

**Table 2-4** U2600A series J1 connector pin assignment

11	GND	+12 V	+12 V	GND	USB_D+	USB_D-	GND
10	GND	+12 V	+12 V	+12 V	GND	GND	GND
9	GND	+12 V	+12 V	+12 V	GND	USB_VBUS	GND
8	GND	NC	BRSV	GND	NC	NC	GND
7	GND	NC	GA0	NC	GND	NC	GND
6	GND	NC	GA1	GND	NC	NC	GND
5	GND	NC	GA2	NC	GND	NC	GND
4	GND	NC	STAR_TRIG	GND	NC	NC	GND
3	GND	NC	GND	NC	GND	NC	GND
2	GND	NC	NC	GND	NC	NC	GND
1	GND	NC	GND	NC	GND	NC	GND
	Z	A	B	C	D	E	F

**Table 2-5** U2600A series J1 connector legend

Pin	Descriptions
+12 V	+12 V power from backplane
GND	Ground
BRSV	Reserved pin
STAR_TRIG	Star trigger
USB_VBUS	USB bused power, +5 V
USB_D+, USB_D-	USB differential pair



# 3 Features and Functions

Digital Input/Output	42
Virtual Port Group Function	47
Interrupt Function	49
Trigger Function	53

This chapter describes the features and functions of the Keysight U2600A Series USB isolated digital input/output modules. This includes the operations of the isolated digital input/output, group function, interrupt function and trigger function.

## Digital Input/Output

The U2600A Series USB isolated digital input/output modules provide up to 64-bit of high density opto-isolated digital input and output for USB 2.0 interface-based industrial applications.

The 32-bit U2651A DIO model is segmented into eight channels with four channels as digital input channels (CH101 to CH104) and four channels as digital output channels (CH201 to CH204). Each channel consists of eight data bit. Refer to [“Connector Pins Configuration for U2651A”](#) on page 33 for more information on the pins configuration.

The 64-bit U2652A digital input model is segmented into eight channels where all channels are digital input channels (CH101 to CH108). Each channel consists of eight data bit. Refer to [“Connector Pins Configuration for U2652A”](#) on page 35 for more information on the pins configuration.

The 64-bit U2653A digital output model is segmented into eight channels where all channels are digital output channels (CH201 to CH208). Each channel consists of eight data bit. Refer to [“Connector Pins Configuration for U2653A”](#) on page 37 for more information on the pins configuration.

## Isolated digital input channels

The U2600A Series USB isolated DIO modules are equipped with up to 64-bit of opto-isolated digital input, which provides electrical isolation protection to the inner DIO circuitry. The circuit diagram of an isolated input bit is shown in [Figure 3-1](#). The maximum and minimum allowable input voltage at  $DI_{in}$  and  $DI_{COM}$  are 24 V and -24 V, respectively; regardless of its polarity as shown below:

- 1 24 V at  $DI_{in}$  and -24 V at  $DI_{COM}$  or
- 2 24 V at  $DI_{COM}$  and -24 V at  $DI_{in}$ .

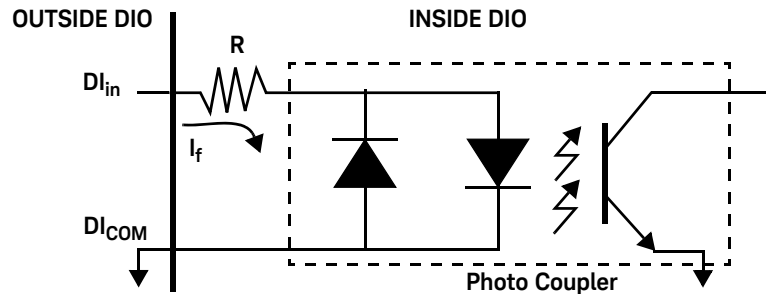

**Figure 3-1** Isolated digital input bit through a photo coupler

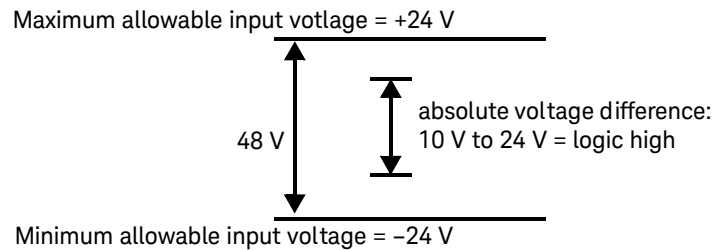

**Figure 3-2** The maximum and minimum allowable input voltage at  $DI_{in}$  and  $DI_{COM}$  and the absolute voltage range for DIO to see a logic high

For the DIO module to read the digital input as logic high, the absolute input voltage range (regardless of its polarity) across the  $DI_{in}$  and  $DI_{COM}$  should be in the range from 10 V to 24 V (see [Figure 3-2](#)). For example, the voltage at  $DI_{in}$  should be greater than  $DI_{COM}$  by at least 10 V (up to 24 V) or the voltage at  $DI_{COM}$  should be greater than  $DI_{in}$  by at least 10 V (up to 24 V). As long as there is an absolute potential difference of more than 10 V (up to 24 V) across  $DI_{in}$  and  $DI_{COM}$ , the DIO module will see a logic high at that bit.

**CAUTION**

Do not supply excessive voltage to the digital input bits as it will cause excessive heating on the resistor and damage the instrument. The maximum absolute voltage difference is 24 V.

---

### Isolated digital output channels

The common ground connection of isolated digital output is shown in the [Figure 3-3](#). When the isolated digital output is switched **ON**, the current will conduct on the power MOSFET (see [Figure 3-3](#)) and the current will flow as indicated by the arrow. When the isolated digital output is switched **OFF**, the current will not conduct through the load (see [Figure 3-4](#)).

**CAUTION**

When the load is of an inductance nature such as relay, coil or motor, the VDD pin should be connected to an external power source.

---

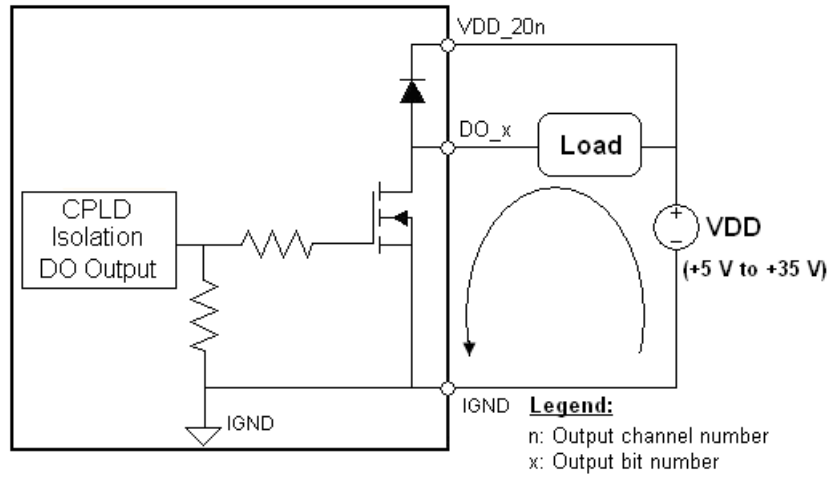

**Figure 3-3** Isolated digital output is switched on with load

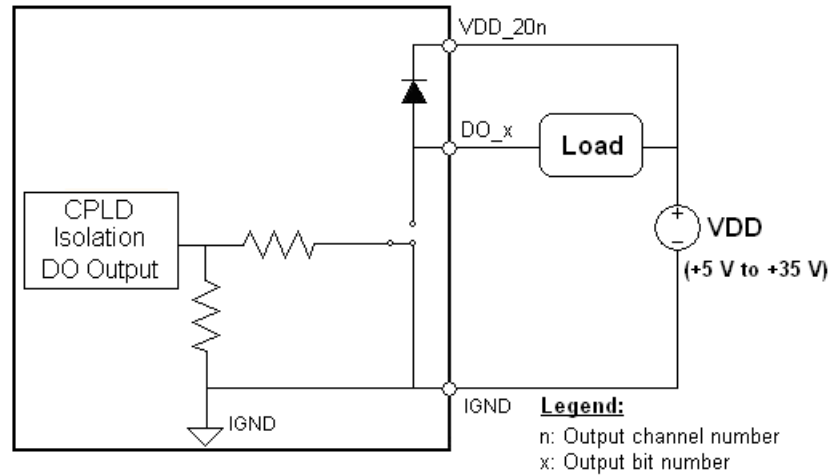

**Figure 3-4** Isolated digital output is switched off with load

A fly-wheel diode is provided at the drain of the MOSFET. It is used in closed loop current release and to protect the MOSFET from any high reversed voltage, which may be generated by the inductive load when the output stage is being switched from **ON** to **OFF**.

The following SCPI examples show the way to read a digital input channel and to output a digital output signal.

#### SCPI Example 1, Read one bit of a digital input channel

```
-> DIG:DATA:BIT? 1, (@101) // Read bit 1 of channel 101
<- 1 // The return value will be either 1 or 0.
// 1 means there is a input at that
// particular bit.
```

#### SCPI Example 2, Read a digital input channel

```
-> DIG:DATA:BYTE? (@101) // Read digital input at channel 101
-> 9 // The return value is in decimal, where
// 9 means bit 0 and bit 3 of channel 101
// have digital inputs.
```

#### SCPI Example 3, Output a signal at one bit of a digital output channel

```
-> SOUR:DIG:DATA:BIT 1,6, (@201) // Set to "1" for bit 6 of channel 201.
-> SOUR:DIG:DATA:BIT? 6, (@201) // Query the output signal at bit 6 of
// channel 201.
<- 1 // Return of "1" means there is an
// output signal.
```

#### SCPI Example 4, Output a signal at a digital output channel

```
-> SOUR:DIG:DATA:BYTE 123, // Output 123 (in decimal) at channel
// (@201:204) 201 to 204.
-> SOUR:DIG:DATA:BYTE? // Query the output signal at channel
// (@201:204) 201 to 204.
<- 123,123,123,123
```

## Virtual Port Group Function

The U2600A Series USB isolated DIO modules allow you to randomly select any eight input bits or output bits and group them into one channel as a virtual DIO port. You must select exactly eight bits to group them to a virtual channel. However, only input bits can be grouped with input bits and output bits with output bits. Therefore, the input bits should not be grouped with the output bits.

### NOTE

You must select exactly eight input bits and group them into virtual channel 199 or exactly eight output bits and group them into channel 299.

For input operations, the channel number is 199 and for output operations, the channel number is 299. The grouping does not need to be sequential in nature, since the bits in channel 199 or 299 will link the specified bits to its reference points.

The following shows the examples of SCPI commands on how to group the input bits in channel number 199 and output bits in channel number 299.

### SCPI Example 1, Grouping the input bits

```
// Group the eight input bits in channel number 199
-> CONF:DIG:GRO
    101.0,101.3,102.5,102.2,102.5,102.7,101.2,102.6, (@199)
-> DIG:DATA? (@199)           // Query the values at the channel
```

### SCPI Example 2, Grouping the output bits

```
// Group the eight output bits in channel number 299  
-> CONF:DIG:GRO  
    202.0,202.3,202.5,202.7,203.5,203.7,204.0,204.5, (@299)  
-> SOUR:DIG:DATA 0, (@299)      // Set channel number 299 to output  
                                all zeros  
  
// Group different output bits in channel number 299  
-> CONF:DIG:GRO  
    202.0,202.1,202.5,202.7,203.5,203.7,204.0,204.5, (@299)  
-> SOUR:DIG:DATA 1, (@299)      // Set channel number 299 to output  
                                with ones
```



## Interrupt Function

This feature is available for the U2651A and U2652A. There are two interrupt sources for the interrupt function, which are bit 301 and bit 302 located at input channel 101. They are actually physically sharing the same bit with bit 101.0 and bit 101.1. See “[Connector Pins Configuration for U2651A](#)” on page 33 and “[Connector Pins Configuration for U2652A](#)” on page 35 for the location of bit 301 and bit 302.

To use this feature, the user has to enable the interrupt first by selecting the triggering source (i.e. bit 301 or bit 302). For example, the following SCPI command is used to set bit 301 as the triggering source.

```
SENS:DIG:INT:ENAB ON, (@301)
```

When the logic level of bit 301 changes from “0” to “1” (i.e. an interrupt has occurred), the bit 0 of *Event Register* (EV) is set to “1”. See [Figure 3-5](#). To alert the *Status Byte Register* that an interrupt has occurred, the user has to enable the *Enable Register* (EN) at the *Interrupt Operation Register* using the following SCPI command:

```
STAT:INT:ENAB 1
```

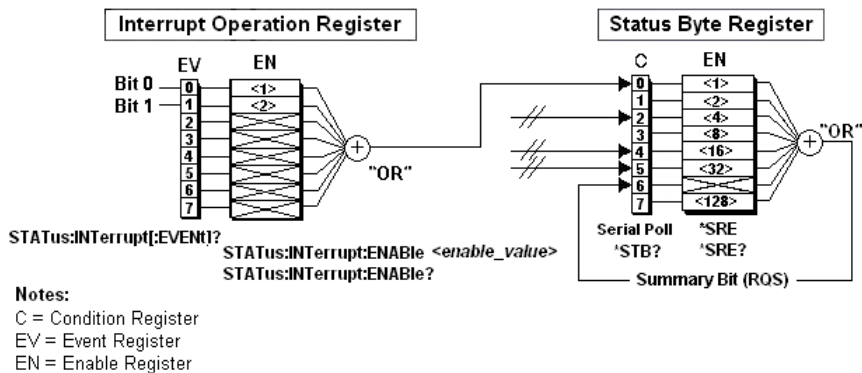

**Figure 3-5** Enabling the Interrupt Operation Register will allow it to send a signal, “1” to the Status Byte Register when either the logic level for bit 301 or bit 302 changes from “0” to “1”.

The *Enable Register* acts like a gate for the *Interrupt Operation Register*. If the *Event Register* is not enabled (i.e. gate is close), the interrupt signal will not be sent to the *Status Byte Register*. If the *Event Register* is enabled, the interrupt signal will be sent to bit 0 of the *Status Byte Register*. To check whether the *Enable Register* is enabled, use the following SCPI command:

**STAT:INT:ENAB?**

If the return value is “1” (in binary is 01), it means that the information at bit 0 of *Event Register* in *Interrupt Operation Register* will be sent to bit 0 of *Status Byte Register*. If the return value is “2” (in binary is 10), it means that the information at bit 0 of *Event Register* in *Interrupt Operation Register* will be sent to bit 0 of *Status Byte Register*. To enable both bit 0 and bit 1 of *Enable Register* to send the information in bit 0 and bit 1 of *Event Register* in *Interrupt Operation Register*, send the following SCPI command:

**STAT:INT:ENAB 3**

The user may send the SCPI command “\*STB?” to query the status of the *Status Byte Register* and observe bit 0 of the return value to check whether an interrupt has occurred provided that the user has previously select the trigger source and enable the *Enable Register* of the *Interrupt Operation Register*.

The flowchart in [Figure 3-6](#) shows an example of the interrupt function operation.

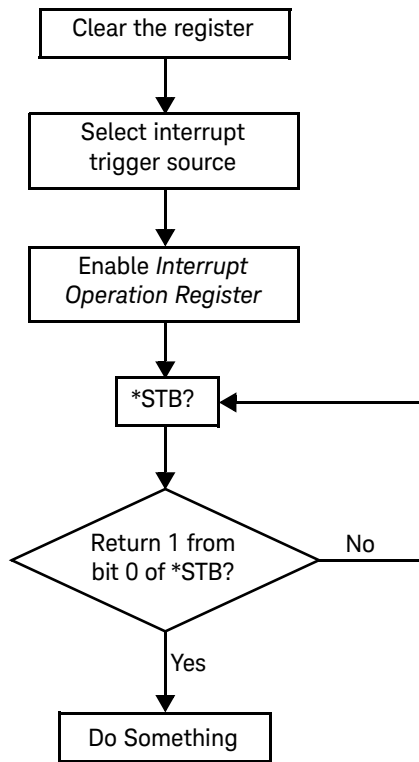

**Figure 3-6** Flowchart for interrupt function operation

Firstly, it is recommended to clear the register prior to enabling the interrupt function. Use the SCPI command “\*CLS” to clear the register.

Secondly, choose the trigger source (for example bit 301) using the SCPI command “SENS:DIG:INT:ENAB ON, (@301)”.

Then, enable the *Interrupt Operation Register* so that it will alert the *Status Byte Register* whenever an interrupt has occurred.

Finally, check the status in *Status Byte Register* with the SCPI command “\*STB?”. If bit 0 of STB returns “1”, it means that an interrupt has occurred. If bit 0 of STB returns “0”, continue to check its status. The user may do something when an interrupt has occurred, for example output a signal from the DIO device.

## SCPI Example 1, Enable interrupt at bit 301 and

```

-> *RST;*CLS // Clears the register to start from
              known state
-> SENS:DIG:INT:ENAB ON, (@301) // Enable interrupt for bit 0
-> ... // Interrupt occurs in bit 301
-> *STB? // Query Status Byte Register
<- +0 // Interrupt occurred but STB doesn't
       see it yet
-> STAT:INT:ENAB 1 // Enable the bit so STB can see it
-> *STB? // Query STB again
<- +1 // Now STB sees that an interrupt has
       occurred
-> STAT:INT:EVEN? // Find out which interrupt source
<- +1 // "1" means the interrupt source is
       from bit 301
-> STAT:INT:EVEN? // Once read the event is cleared
<- +0 // 0 now. If there is another interrupt, it
       will be set to 1 again

```

**NOTE**

Refer to *U2600A Series Programmer's Reference* under the topic "[SENSE:]DIGital:INTerrupt[:ENABLE]" for more example on interrupt function.

---

## Trigger Function

The major difference between interrupt function and trigger function is that after the user selects any trigger source, the IO operation will be frozen. In other words, the output will stay at the previous stage and the input reading values will also be frozen. Whereas for the interrupt function, the IO operation is still running.

The following flowchart illustrates the way the trigger function operates.

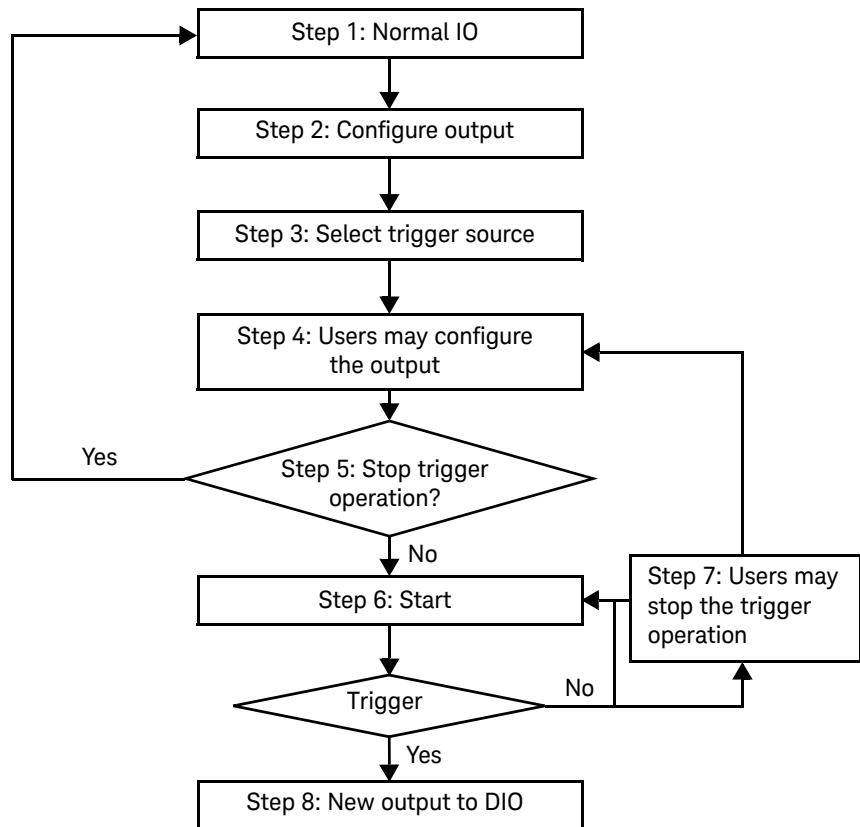

**Figure 3-7** Flowchart for trigger function operation

**Table 3-1** Step-by-step descriptions for trigger function flowchart

Steps	Descriptions
Step 1	By default, no trigger source is selected ( <b>TRIG:SOUR NONE</b> ). Hence, all digital inputs and digital outputs will operate immediately.
Step 2	<p>Users may configure the desired output values before a trigger occurred. For example:</p> <p>-&gt; <b>SOUR:DIG:DATA:BYTE 123, (@201:204)</b></p> <p>And read the input values, for example:</p> <p>-&gt; <b>SENS:DIG:DATA:BYTE? (@101:104)</b></p> <p>&lt;- <b>111,111,111,111</b></p>
Step 3	<p>Select one of the trigger source. (<b>TRIG:SOUR 301   302   STRG</b>)</p> <p>The star trigger "<b>STRG</b>" trigger source can only be used when the DIO module is installed in a modular instrument U2700A chassis.</p>
Step 4	<p>All IO operation will freeze when the user select one of the trigger source. So, if the user supply 98 to the input, sending the query command "<b>SENS:DIG:DATA:BYTE? (@101:104)</b>" will return "<b>111,111,111,111</b>" even the supply value at the DIO module has changed to 98 (for this case).</p> <p>At this stage, users are allow to configure the output values. For example:</p> <p>-&gt; <b>SOUR:DIG:DATA:BYTE 220, (@201:204)</b></p> <p>-&gt; <b>SOUR:DIG:DATA:BYTE? (@201:204)</b></p> <p>&lt;- <b>220,220,220,220</b></p> <p>Even though the query command returns "<b>220,220,220,220</b>", the real output value at the hardware DIO module will remain the same as previous stage (Step 2), which is 123 in this case. The output value will remain at 123 until the DIO module receives the trigger signal.</p>
Step 5	Users may stop trigger operation at this stage by sending the command " <b>TRIG:SOUR NONE</b> ". If this command is sent without receiving any trigger signal, then the query of this command " <b>SOUR:DIG:DATA:BYTE? (@201:204)</b> " should give back the previous stage (Step 2) value, which is 123 in this example but not 220.
Step 6	Send the command " <b>TRIG:MON ON</b> " to start monitoring the trigger signal. Users are <b>NOT</b> allowed to change the output setting at this stage.

**Table 3-1** Step-by-step descriptions for trigger function flowchart (continued)

Steps	Descriptions
Step 7	Users can stop monitoring the trigger signal manually at any time. To stop monitoring, send the command "TRIG:MON OFF".
Step 8	If trigger happen, DIO module will output 220 (as configured in Step 4). The device will return to normal IO operation. So, when read the input value, it will return 98 (in this case).  The command "TRIG:MON:STAT?" is used to query the current monitoring status process. For example, when this command is sent at this stage:  -> TRIG:MON:STAT? <- +1  -> TRIG:MON:STAT? <- +0  The "+1" indicates that trigger has happened. But this will only be shown once. If the query command is sent for the second time, it will reset to "+0".  The monitoring process will stop after trigger signal is received.  -> TRIG:MON? <- 0

Example 1, Trigger did not happen

```

-> *RST; *CLS
-> SOUR:DIG:DATA:BYTE 123,
    (@201,203)
-> SOUR:DIG:DATA:BYTE 99,
    (@202,204)
-> SOUR:DIG:DATA:BYTE?
    (@201:204)
<- 123,99,123,99                                     // Actual hardware value at
                                                         123,99,123,99

-> TRIG:SOUR 301                                       // Setting trigger source will not affects
                                                         the output value. Thus, output values
                                                         remained

-> SOUR:DIG:DATA:BYTE?
    (@201:204)
<- 123,99,123,99

-> SOUR:DIG:DATA:BYTE 44,
    (@201,202)                                       // Configure output value only. The
                                                         actual hardware output did not change
                                                         yet, still remain at 123,99,123,99

-> SOUR:DIG:DATA:BYTE 222,
    (@203,204)
-> SOUR:DIG:DATA:BYTE?
    (@201:204)                                       // Actual hardware value is
                                                         123,99,123,99 but SCPI show
                                                         44,44,222,222. The SCPI value will be
                                                         source out, if the DAQ receives the
                                                         trigger signal

-> TRIG:SOUR NONE                                     // User decides not to use trigger
                                                         function anymore. Trigger does not
                                                         happen

-> SOUR:DIG:DATA:BYTE?
    (@201:204)                                       // Since trigger did not happen, the
                                                         output value did not change. Thus
                                                         SCPI return 123,99,123,99 to show the
                                                         actual hardware status

<- 123,99,123,99

```



## Example 2, Trigger happen

```

-> *CLS; *RST
-> SOUR:DIG:DATA:BYTE 11, (@204)
-> SOUR:DIG:DATA:BYTE 233,
    (@201)
-> SOUR:DIG:DATA:BYTE 9, (@202)
-> SOUR:DIG:DATA:BYTE 205,
    (@203)
-> SOUR:DIG:DATA:BYTE?
    (@201:204)
-> 233,9,205,11 // Actual hardware value at
                  233,9,205,11

-> TRIG:SOUR 302 // Set trigger source at 302
-> SOUR:DIG:DATA:BYTE? // SCPI value remain
    (@201:204)
<- 233,9,205,11

-> SOUR:DIG:DATA:LWOR // User may configure the output value
    40154879, (@201) as many times as they like using
                    different type "SOUR" command. But
-> SOUR:DIG:DATA:WORD? // the actual hardware value will not
    (@201,203) change until a trigger signal is received
<- 46847,612

-> SOUR:DIG:DATA:BYTE?
    (@201:204)
-> 255,182,100,2

-> SOUR:DIG:DATA:BYTE 33, (@202) // The last configured SOUR value will
-> SOUR:DIG:DATA:BYTE 145, // determine the later hardware value
    (@201) when a trigger signal is received

-> SOUR:DIG:DATA:WORD 6523,
    (@203)
-> SOUR:DIG:DATA:BYTE?
    (@201:204)

```

```

-> 145,33,123,25
-> TRIG:MON ON // Start monitor the trigger signal
// After start monitor trigger signal, users are not allow to change SOUR
command
-> SOUR:DIG:DATA:BYTE 23,(@201)
-> SYST:ERR?
<- +308,“Channel not able to perform requested operation;
Chan 201”
-> SOUR:DIG:DATA:BYTE? // However, user is still allow to make
(@201:204) query on SOUR command. Note that
<- 145,33,123,25 the actual hardware is still at
233,9,205,11 but SCPI value is at
145,33,123,25

```

**\*\*\* Trigger happen \*\*\***

```

-> TRIG:MON:STAT? // Check whether trigger had
<- +1 happened and reset to zero when user
-> TRIG:MON:STAT? query for second time
<- +0
-> TRIG:MON? // This command will also be reset to
<- 0 OFF, indicating that the trigger
monitoring process has been stopped
-> SOUR:DIG:DATA:BYTE? // Now the SCPI and actual hardware
(@201:204) value are the same, which is
<- 145,33,123,25 145,33,123,25

```

**\*\*\* From here onwards, user may choose to continue with trigger or turn off trigger \*\*\***

```

-> TRIG:SOUR NONE // Turn off trigger function
-> SOUR:DIG:DATA:BYTE?(@201:204) // Now the SOUR query command
<- 145,33,123,25 shows the actual hardware value,
which is 145,33,123,25

```

**Example 3, Interrupt commands during trigger are not allow**

E.g. 1: After trigger source is selected, interrupt function feature is not allowed

```

-> *CLS; *RST
-> TRIG:SOUR 302           // Set 302 as trigger source
// Interrupt command is not allow in trigger mode. If used, an error will occur.
-> DIG:INT 1,(@301)
-> SYST:ERR?
<- +308,“Channel not able to perform requested operation;
   Chan 301”
-> DIG:INT 1,(@302)
-> SYST:ERR?
<- +308,“Channel not able to perform requested operation;
   Chan 302”
-> DIG:INT? (@301:302)    // However, user can check whether
                           the interrupt is enabled
<- 0,0

```

E.g 2: Interrupt feature is disabled if a trigger source is selected

```

-> *CLS; *RST
-> DIG:INT 1, (@302)           // Interrupt command is not allow in
-> DIG:INT? (@301:302)       trigger mode. If used, an error will
<- 0,1                       occur.
-> TRIG:SOUR 301             // Select 301 as trigger source
-> DIG:INT? (@301)           // Interrupt feature will be
<- 0                          automatically disabled when user
-> DIG:INT? (@302)           select trigger source. "0" means the
<- 0                          interrupt function is not enabled.
-> DIG:INT? (@301:302)
<- 0,0
-> TRIG:SOUR NONE           // Turn off the trigger source
-> DIG:INT? (@301:302)       // This query command will still
<- 0,0                       return 0,0

```

E.g. 3: STRG as the trigger source when used in the instrument modular chassis (U2781A)

```

-> *CLS; *RST
-> TRIG:SOUR STRG           // Select STRG as trigger source
-> STAT:INT:ENAB 3         // No error generated when enable the
-> STAT:INT ENAB?         "STRG" trigger source. This command
<- +3                     can still be use because it is only an
-> STAT:INT?              enable register. Since interrupt
<- +0                     comand has been disabled, this
                          command have no effect on interrupt
                          or trigger.

```

## Example 4, Group command during trigger

```

-> *CLS; *RST
-> CONF:DIG:GRO
    101.3,104.2,101.7,102.5,103.6,102.0,103.4,102.1,(@199)
-> CONF:DIG:GRO
    203.2,201.4,204.3,202.7,201.5,204.1,203.0,201.2,(@299)
-> SOUR:DIG:DATA:BYTE 234,(@299)
-> SOUR:DIG:DATA:BYTE? (@299)
<- 234
-> SOUR:DIG:DATA:BYTE? (@201:204) // Actual hardware value at 20,128,1,2
<- 20,128,1,2
-> TRIG:SOUR 302 // Set 302 as trigger source
-> SOUR:DIG:DATA:BYTE? (@201:204)
<- 20,128,1,2
-> SOUR:DIG:DATA:BYTE? (@299)
<- 234
-> SOUR:DIG:DATA:BYTE 31,(@299)
-> SOUR:DIG:DATA:BYTE? (@299)
<- 31
-> SOUR:DIG:DATA:BYTE? (@201:204)
<- 48,128,4,8
-> TRIG:MON ON
-> SOUR:DIG:DATA:BYTE 23,(@299)
-> SYST:ERR?
<- +308,"Channel not able to perform requested operation;
    Chan 299"

```

*// However, users are still allow to re-arrange the channels in 299 or 199 since it will not alter the SCPI value, 48,128,4,8*

```
-> CONF:DIG:GRO
    201.2,202.4,203.3,204.7,201.5,202.1,203.0,204.2,(@299)
-> CONF:DIG:GRO
    101.3,102.2,103.7,104.5,101.6,102.0,103.4,104.1,(@199)
-> SOUR:DIG:DATA:BYTE? (@299) // Although this value has changed
<- 16                          // from 31 to 16 due to re-configured of
                                // the channels, it will not affect the SCPI
-> SOUR:DIG:DATA:BYTE?       // value. The value in channel 201:204
    (@201:204)                // still remain unchanged. Note that
<- 48,128,4,8                // before the trigger occur, the hardware
                                // value still at 20,128,1,2 but SCPI value
                                // is at 48,128,4,8
```

**\*\*\* TRIGGER OCCURED \*\*\***

```
-> TRIG:MON:STAT?           // Check whether a trigger signal is
                                // detected
<- +1                       // "1" mean trigger signal is detected
-> TRIG:MON:STAT?         // Query the second will receive "0"
<- +0                       // because this command auto-reset the
                                // register to "0"
-> TRIG:MON?              // Trigger monitoring process will be
<- 0                        // auto turned off when a trigger source is
                                // detected
-> SOUR:DIG:DATA:BYTE?     // After the trigger signal is detect, the
    (@201:204)             // SCPI and actual hardware value are the
<- 48,128,4,8             // same, which is 48,128,4,8
-> SOUR:DIG:DATA:BYTE? (@299)
<- 16
```

**\*\*\* From here onwards, users may choose to continue with trigger or turn off trigger function \*\*\***

```
-> TRIG:SOUR NONE          // Turn off trigger function
```

# 4 Characteristics and Specifications

For the characteristics and specifications of the U2600A Series USB Isolated Digital Input/Output Modules, refer to the datasheet at <http://literature.cdn.keysight.com/litweb/pdf/5991-0665EN.pdf>.

THIS PAGE HAS BEEN INTENTIONALLY LEFT BLANK.



# 5 Dismantle Procedures

General Disassemble	66
Troubleshooting	70
Self-Test Procedures	71

This chapter describes the step-by-step disassemble procedures and list the available replacement parts for U2600A Series USB isolated digital input/output modules.

## General Disassemble

This chapter provides the step-by-step guides on how to dismantle the module and install the replacement assembly. To assemble back the module, follow the instructions in reverse order.

### NOTE

The parts shown in the following figures are representative and may look different than what you have in your module.

The removable assemblies include:

- Plastic casing
- Metal casing
- Rear metal casing
- Front metal casing, which is attached to the carrier board and measurement board

## Mechanical disassemble

Follow the instructions in this section for the instrument disassemble process.

**Step 1: Pull the bumper out to remove the plastic casing.**

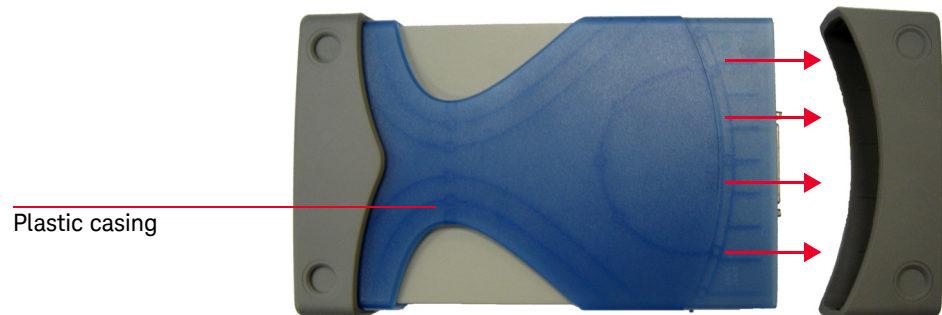

Step 2: Flip the plastic casing open.

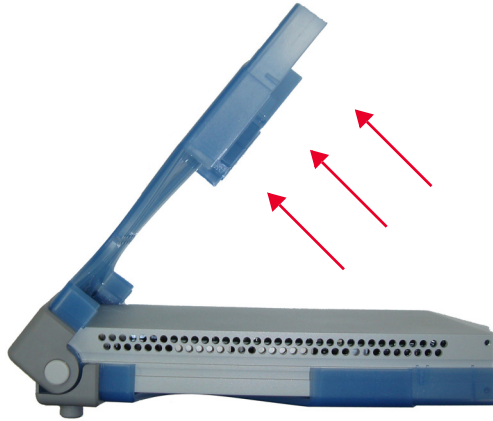

Step 3: Slide the metal casing out of the plastic casing.

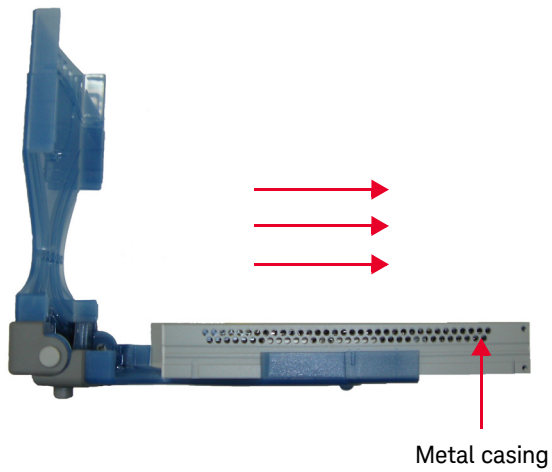

Step 4: Unscrew all the following indicated screws from metal casing.

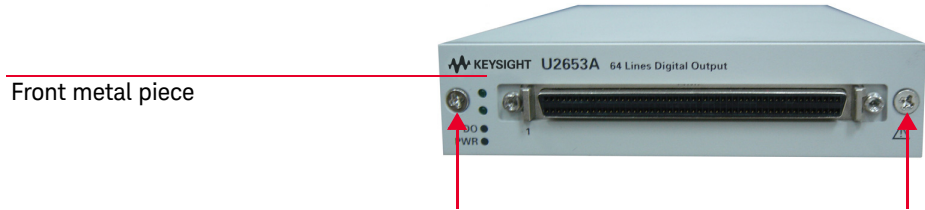

Step 5: Gently pull the front metal piece out, which is attached to the carrier and measurement boards.

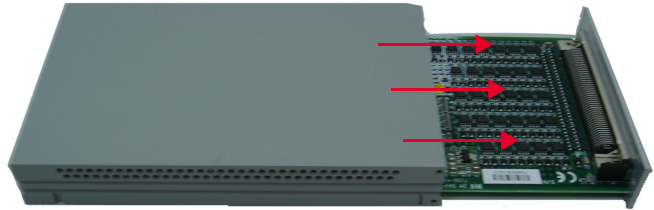

Step 6: Unscrew all the following indicated screws from the metal casing and remove the rear metal piece.

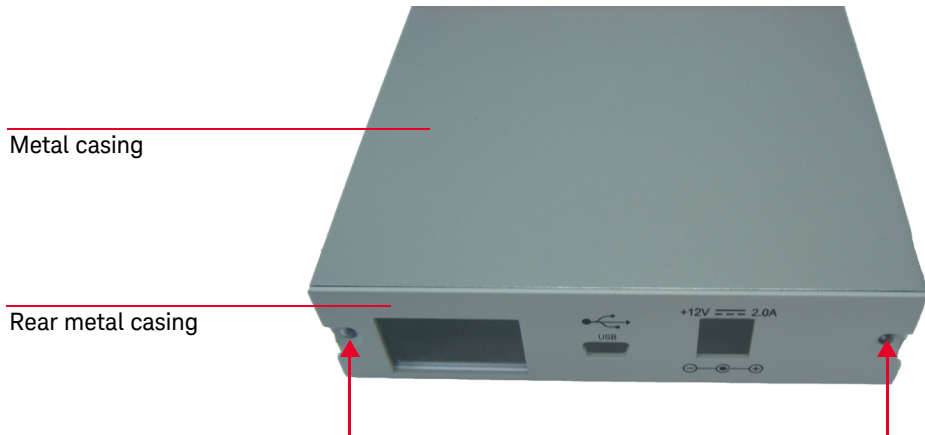

Disassembled parts

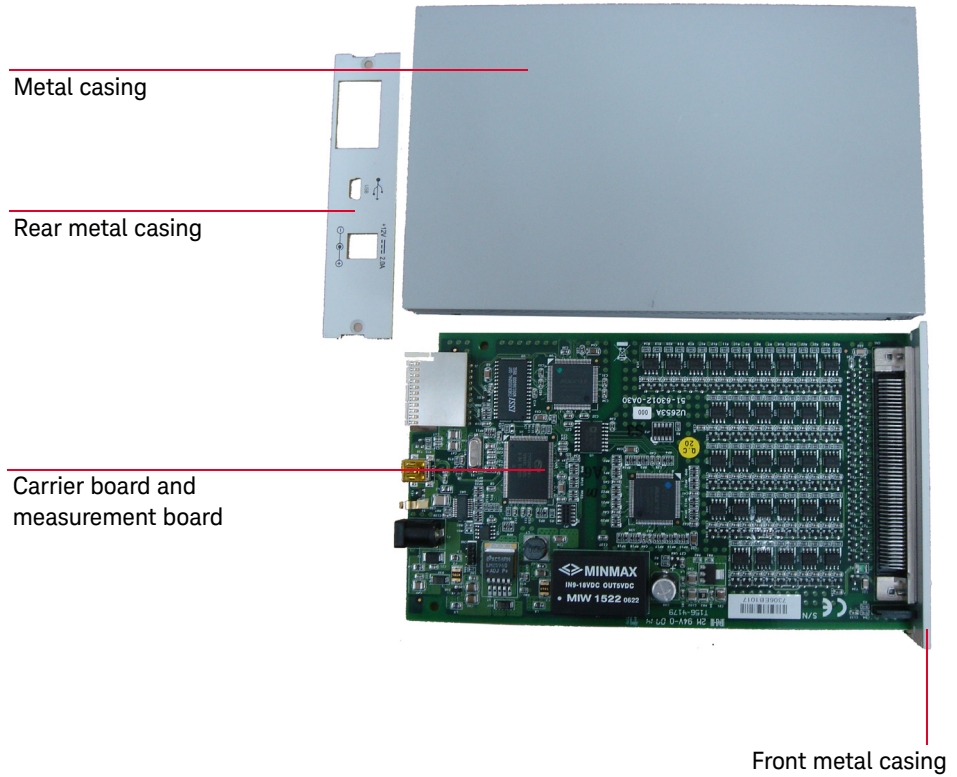

## Troubleshooting

This section provides suggestions for solving general problems that you may encounter with the instrument. It guides you on what to check in the following situations:

### **1 Power Indicator LED is not lit**

Verify that the ac power cord is connected to the power inlet in the DAQ device.

### **2 Power Indicator LED is lit but the AO/ AI Indicator LED is not lit**

Verify that the USB cable is connected to the PC and the USB inlet in the DAQ device.

### **3 Power Indicator LED is lit and AO/ AI Indicator LED is lit**

Verify if the SCPI commands are correct with “**SYSTem:ERRor?**” command.

Refer to *U2600A Series USB Multifunction Programming Guide* for SCPI error messages.

#### **NOTE**

If there are no response from the instrument, contact the nearest Keysight Service Center to obtain further assistance.

---

## Self-Test Procedures

**WARNING**

Do not connect any cables and terminal block prior to performing self-test procedures.

---

- 1 Go to **Start > All Programs > Keysight IO Libraries Suite > Keysight Connection Expert** to launch the Keysight Connection Expert.
- 2 Go to **Start > All Programs > Keysight T&M Toolkit > Keysight Interactive IO** to launch the Interactive I/O dialog box.
- 3 Send the SCPI command “\*TST?” to the instrument to start perform the self-test of the instrument.
- 4 The command will return either “+0” to indicate all tests passes or “+1” to indicate one or more tests failed.
- 5 If the command returns “+1”, apply SCPI command “SYSTem:ERRor?” to enquire the error message.

**NOTE**

Refer to *Keysight U2600A Series USB Multifunction Data Acquisition Programming Guide* for SCPI error messages.

---

THIS PAGE HAS BEEN INTENTIONALLY LEFT BLANK.





This information is subject to change without notice. Always refer to the Keysight website for the latest revision.

© Keysight Technologies 2007-2017  
Edition 7, June 1, 2017

Printed in Malaysia



U2651-90011

[www.keysight.com](http://www.keysight.com)