

# Keysight U2500A Series USB Simultaneous Sampling Multifunction Data Acquisition Devices



NOTICE: This document contains references to Agilent Technologies. Agilent's former Test and Measurement business has become Keysight Technologies. For more information, go to [www.keysight.com](http://www.keysight.com).



# Notices

## Copyright Notice

© Keysight Technologies 2007-2017

No part of this manual may be reproduced in any form or by any means (including electronic storage and retrieval or translation into a foreign language) without prior agreement and written consent from Keysight Technologies as governed by United States and international copyright laws.

## Trademarks

Pentium is a U.S. registered trademark of Intel Corporation.

Microsoft, Visual Studio, Windows, and MS Windows are trademarks of Microsoft Corporation in the United States and/or other countries.

## Manual Part Number

U2541-90011

## Edition

Edition 9, June 1, 2017

## Printed in:

Printed in Malaysia

## Published by:

Keysight Technologies  
Bayan Lepas Free Industrial Zone,  
11900 Penang, Malaysia

## Technology Licenses

The hardware and/or software described in this document are furnished under a license and may be used or copied only in accordance with the terms of such license.

## Declaration of Conformity

Declarations of Conformity for this product and for other Keysight products may be downloaded from the Web. Go to <http://www.keysight.com/go/conformity>. You can then search by product number to find the latest Declaration of Conformity.

## U.S. Government Rights

The Software is “commercial computer software,” as defined by Federal Acquisition Regulation (“FAR”) 2.101. Pursuant to FAR 12.212 and 27.405-3 and Department of Defense FAR Supplement (“DFARS”) 227.7202, the U.S. government acquires commercial computer software under the same terms by which the software is customarily provided to the public. Accordingly, Keysight provides the Software to U.S. government customers under its standard commercial license, which is embodied in its End User License Agreement (EULA), a copy of which can be found at <http://www.keysight.com/find/sweula>. The license set forth in the EULA represents the exclusive authority by which the U.S. government may use, modify, distribute, or disclose the Software. The EULA and the license set forth therein, does not require or permit, among other things, that Keysight: (1) Furnish technical information related to commercial computer software or commercial computer software documentation that is not customarily provided to the public; or (2) Relinquish to, or otherwise provide, the government rights in excess of these rights customarily provided to the public to use, modify, reproduce, release, perform, display, or disclose commercial computer software or commercial computer software documentation. No additional government requirements beyond those set forth in the EULA shall apply, except to the extent that those terms, rights, or licenses are explicitly required from all providers of commercial computer software pursuant to the FAR and the DFARS and are set forth specifically in writing elsewhere in the EULA. Keysight shall be under no obligation to update, revise or otherwise modify the Software. With respect to any technical data as defined by FAR 2.101, pursuant to FAR 12.211 and 27.404.2 and DFARS 227.7102, the U.S. government acquires no greater than Limited Rights as defined in FAR 27.401 or DFAR 227.7103-5 (c), as applicable in any technical data.

## Warranty

THE MATERIAL CONTAINED IN THIS DOCUMENT IS PROVIDED “AS IS,” AND IS SUBJECT TO BEING CHANGED, WITHOUT NOTICE, IN FUTURE EDITIONS. FURTHER, TO THE MAXIMUM EXTENT PERMITTED BY APPLICABLE LAW, KEYSIGHT DISCLAIMS ALL WARRANTIES, EITHER EXPRESS OR IMPLIED, WITH REGARD TO THIS MANUAL AND ANY INFORMATION CONTAINED HEREIN, INCLUDING BUT NOT LIMITED TO THE IMPLIED WARRANTIES OF MERCHANTABILITY AND FITNESS FOR A PARTICULAR PURPOSE. KEYSIGHT SHALL NOT BE LIABLE FOR ERRORS OR FOR INCIDENTAL OR CONSEQUENTIAL DAMAGES IN CONNECTION WITH THE FURNISHING, USE, OR PERFORMANCE OF THIS DOCUMENT OR OF ANY INFORMATION CONTAINED HEREIN. SHOULD KEYSIGHT AND THE USER HAVE A SEPARATE WRITTEN AGREEMENT WITH WARRANTY TERMS COVERING THE MATERIAL IN THIS DOCUMENT THAT CONFLICT WITH THESE TERMS, THE WARRANTY TERMS IN THE SEPARATE AGREEMENT SHALL CONTROL.

## Safety Information

















### CAUTION

A CAUTION notice denotes a hazard. It calls attention to an operating procedure, practice, or the like that, if not correctly performed or adhered to, could result in damage to the product or loss of important data. Do not proceed beyond a CAUTION notice until the indicated conditions are fully understood and met.

### WARNING

A WARNING notice denotes a hazard. It calls attention to an operating procedure, practice, or the like that, if not correctly performed or adhered to, could result in personal injury or death. Do not proceed beyond a WARNING notice until the indicated conditions are fully understood and met.

## Safety Symbols

|   |                                     |   |  |
|---|-------------------------------------|---|--|
|    | Direct current                      |    | On (Supply)  |
|    | Alternating current                 |    | Off (Supply)   |
|    | Both direct and alternating current |    | Equipment protected throughout by double insulation or reinforced insulation |
|    | Three-phase alternating current     |    | Caution, risk of electric shock  |
|    | Earth (ground) terminal             |    | Caution, hot surface   |
|    | Protective conductor terminal       |    | Caution, risk of danger (See note.)  |
|   | Frame or chassis terminal           |    | In position of a bi-stable push control                                      |
|  | Equipotentiality                    |  | Out position of a bi-stable push control                                     |

## General Safety Information

The following general safety precautions must be observed during all phases of this instrument. Failure to comply with these precautions or with specific warnings elsewhere in this manual violates safety standards of design, manufacture, and intended use of the instrument. Keysight Technologies, Inc. assumes no liability for the customer's failure to comply with these requirements.

### WARNING

- Do not use the device if it is damaged. Before you use the device, inspect the case. Look for cracks or missing plastic. Do not operate the device around explosive gas, vapor, or dust.
  - Do not apply more than the rated voltage (as marked on the device) between terminals, or between terminal and external ground.
  - Always use the device with the cables provided.
  - Observe all markings on the device before connecting to the device.
  - Turn off the device and application system power before connecting to the I/O terminals.
  - When servicing the device, use only specified replacement parts.
  - Do not operate the device with the removable cover removed or loosened.
  - Do not connect any cables and terminal block prior to performing self-test process.
  - Use only the power adapter supplied by the manufacturer to avoid any unexpected hazards.
-

**CAUTION**

- Do not load the output terminals above the specified current limits. Applying excessive voltage or overloading the device will cause irreversible damage to the circuitry.
  - Applying excessive voltage or overloading the input terminal will damage the device permanently.
  - If the device is used in a manner not specified by the manufacturer, the protection provided by the device may be impaired.
  - Always use dry cloth to clean the device. Do not use ethyl alcohol or any other volatile liquid to clean the device.
  - Do not permit any blockage of the ventilation holes of the device.
-

## Regulatory Markings

|   |   |
|---|---|
|  <p>The CE mark is a registered trademark of the European Community. This CE mark shows that the product complies with all the relevant European Legal Directives.</p> |  <p>The CSA mark is a registered trademark of the Canadian Standards Association. A CSA mark with the indicators “C” and “US” means that the product is certified for both the U.S. and Canadian markets, to the applicable American and Canadian standards.</p> |
| <p><b>ICES/NMB-001</b></p> <p>ICES/NMB-001 indicates that this ISM device complies with Canadian ICES-001.</p>  |  <p>The RCM mark is a registered trademark of the Australian Communications and Media Authority.</p>   |



## Waste Electrical and Electronic Equipment (WEEE) Directive 2002/96/EC

This instrument complies with the WEEE Directive (2002/96/EC) marking requirement. This affixed product label indicates that you must not discard this electrical or electronic product in domestic household waste.

### Product category:

With reference to the equipment types in the WEEE directive Annex 1, this instrument is classified as a “Monitoring and Control Instrument” product.

The affixed product label is as shown below.



Do not dispose in domestic household waste.

To return this unwanted instrument, contact your nearest Keysight Service Center, or visit <http://about.keysight.com/en/companyinfo/environment/takeback.shtml> for more information.

## Sales and Technical Support

To contact Keysight for sales and technical support, refer to the support links on the following Keysight websites:

- [www.keysight.com/find/U2500A](http://www.keysight.com/find/U2500A)  
(product-specific information and support, software and documentation updates)
- [www.keysight.com/find/assist](http://www.keysight.com/find/assist)  
(worldwide contact information for repair and service)

THIS PAGE HAS BEEN INTENTIONALLY LEFT BLANK.

# Table of Contents

|  |    |
|--|----|
| Safety Symbols   | 5  |
| General Safety Information   | 6  |
| Regulatory Markings  | 8  |
| Waste Electrical and Electronic Equipment (WEEE) Directive<br>2002/96/EC | 9  |
| Product category:  | 9  |
| Sales and Technical Support  | 9  |
| <b>1 Getting Started</b>   |    |
| Introduction to U2500A Series DAQ Devices                                | 18 |
| Product Overview   | 19 |
| Product outlook  | 19 |
| Product dimensions   | 20 |
| Terminal Block Overview  | 21 |
| Standard Purchase Items Checklist  | 22 |
| Software Installation  | 23 |
| L-Mount Kit Installation   | 24 |
| General Maintenance  | 26 |
| Additional Information   | 27 |
| Hardware verification  | 27 |
| Sample code  | 28 |
| <b>2 Connector Pins Configuration</b>                                    |    |
| Introduction   | 30 |
| Connector Pins Configuration for U2531A/U2541A/U2542A                    | 31 |
| 55-pin Connector (J1) Pins Configuration                                 | 33 |
| <b>3 Features and Functions</b>  |    |
| Features Overview  | 36 |
| Analog Input Operation Mode  | 37 |

|   |    |
|---|----|
| A/D data conversion                         | 44 |
| AI data format                              | 48 |
| Analog Output Operation Mode                | 50 |
| D/A reference voltage                       | 53 |
| AO data format                              | 54 |
| Digital I/O                                 | 56 |
| General Purpose Digital Counter             | 59 |
| Trigger Sources                             | 65 |
| Trigger types                               | 66 |
| Digital trigger                             | 70 |
| Analog trigger                              | 70 |
| SCPI Programming Examples                   | 74 |
| Analog input                                | 74 |
| Analog output                               | 77 |
| <b>4 Characteristics and Specifications</b> |    |
| <b>5 Calibration</b>                        |    |
| Self-Calibration                            | 82 |

## List of Figures

|             |  |    |
|-------------|--|----|
| Figure 2-1  | Connector in vertical view   | 30 |
| Figure 2-2  | Connector in horizontal view   | 30 |
| Figure 2-3  | Pins configuration for U2531A/U2541A/U2542A  | 31 |
| Figure 2-4  | Connector (J1) 55-pin  | 33 |
| Figure 3-1  | Functional block diagram of U2500A series DAQ device   | 38 |
| Figure 3-2  | General purpose digital counter I/O of U2500A series DAQ device  | 56 |
| Figure 3-3  | General purpose digital counter  | 59 |
| Figure 3-4  | Totalizer mode   | 60 |
| Figure 3-5  | Pre-trigger  | 66 |
| Figure 3-6  | Middle-trigger   | 67 |
| Figure 3-7  | Post-trigger   | 68 |
| Figure 3-8  | Delay-trigger  | 69 |
| Figure 3-9  | Positive and negative edge of digital trigger  | 70 |
| Figure 3-10 | Above high trigger condition   | 71 |
| Figure 3-11 | Below low trigger condition  | 72 |
| Figure 3-12 | Window trigger condition   | 73 |
| Figure 5-1  | Launch the Interactive IO in Keysight Connection Expert  | 83 |
| Figure 5-2  | Interactive IO dialog box  | 84 |
| Figure 5-3  | Self Calibration Form dialog box in Keysight Measurement Manager   | 85 |
| Figure 5-4  | Self Calibration Form dialog box in Keysight Measurement Manager with a device being selected                                  | 86 |
| Figure 5-5  | Self Calibration Form dialog box in Keysight Measurement Manager showing the status and result of the self-calibration process | 86 |

THIS PAGE HAS BEEN INTENTIONALLY LEFT BLANK.

## List of Tables

|            |  |    |
|------------|--|----|
| Table 2-1  | Pins legend for U2531A/U2541A/U2542A   | 32 |
| Table 2-2  | U2500A series J1 connector pin assignment  | 33 |
| Table 2-3  | U2500A series J1 connector legend  | 34 |
| Table 3-1  | Analog input operation overview  | 38 |
| Table 3-2  | Analog input range and digital code output for bipolar                                 | 48 |
| Table 3-3  | Analog input range and digital code output for unipolar                                | 48 |
| Table 3-4  | Analog input range and digital code output for bipolar                                 | 49 |
| Table 3-5  | Analog input range and digital code output for unipolar                                | 49 |
| Table 3-6  | Analog output operation overview   | 50 |
| Table 3-7  | Digital code and voltage output table for bipolar setting (U2531A, U2541A and U2542A)  | 55 |
| Table 3-8  | Digital code and voltage output table for unipolar setting (U2531A, U2541A and U2542A) | 55 |
| Table 3-9  | Trigger type for single-shot acquisition of continuous mode                            | 65 |
| Table 3-10 | Trigger type for continuous acquisition of continuous mode                             | 65 |

THIS PAGE HAS BEEN INTENTIONALLY LEFT BLANK.



Keysight U2500A Series USB Simultaneous Sampling  
Multifunction Data Acquisition Devices  
User's Guide

# 1 Getting Started

|   |    |
|---|----|
| Introduction to U2500A Series DAQ Devices | 18 |
| Product Overview                          | 19 |
| Terminal Block Overview                   | 21 |
| Standard Purchase Items Checklist         | 22 |
| Software Installation                     | 23 |
| L-Mount Kit Installation                  | 24 |
| General Maintenance                       | 26 |
| Additional Information                    | 27 |

This chapter contains instructions on how to get started with the U2500A series DAQ devices that includes a system requirement check, installations of the device's hardware and software, and launching of the Keysight Measurement Manager application software.

## Introduction to U2500A Series DAQ Devices

The Keysight U2500A Series USB Simultaneous Sampling (SS) Multifunction Data Acquisition (DAQ) is a high performance and user friendly device. It can be used as a standalone unit or as a modular unit. However, if used as modular unit, the module needs to be installed in the Keysight U2781A USB modular instrument chassis. The U2500A series consists of three models:

- U2531A: 4 channel SS multifunction DAQ 14 bits 2 MSa/s
- U2541A: 4 channel SS multifunction DAQ 16 bits 250 kSa/s
- U2542A: 4 channel SS multifunction DAQ 16 bits 500 kSa/s

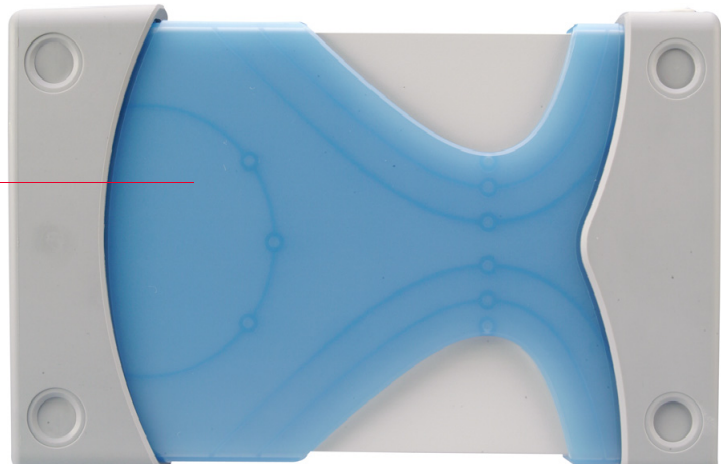
The U2500A series DAQ devices are compatible with a wide range of Application Development Environment (ADE), such as Keysight VEE, LabVIEW, MATLAB, and Microsoft Visual Studio. Bundled with the purchase of every device is an easy-to-use application software, the Keysight Measurement Manager.

# Product Overview

Product outlook

Top view

Plastic Casing



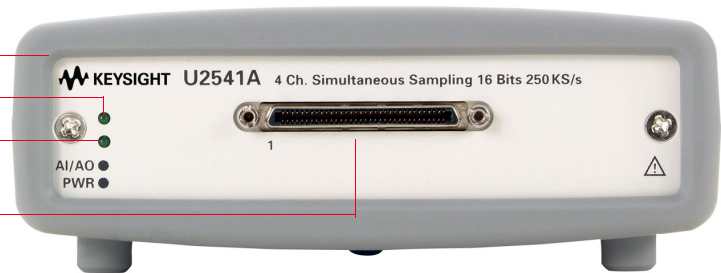
Front view

Bumper

AI/AO Indicator

Power Indicator

Connector



Rear view

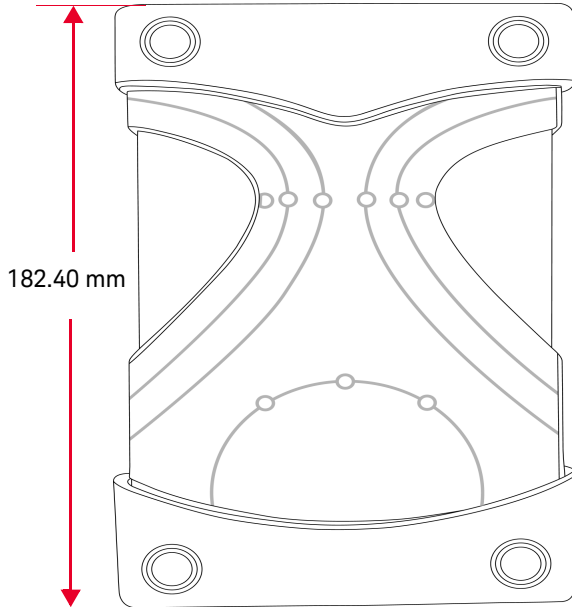
USB Connector

Power Inlet

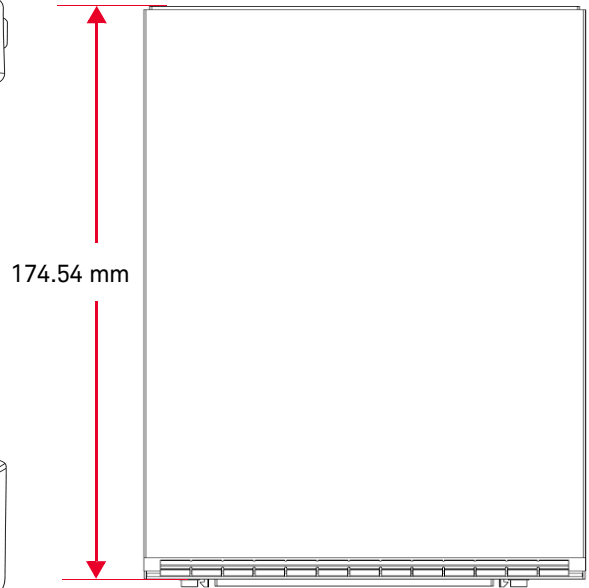


## Product dimensions

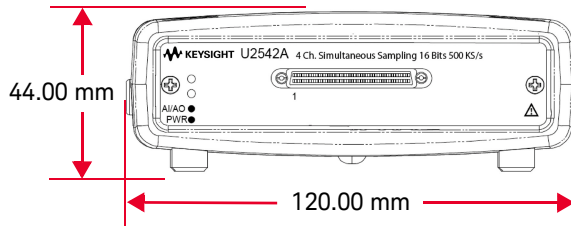
**With plastic casing**  
Top view



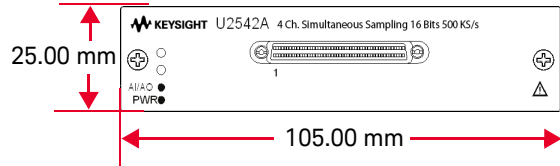
**Without plastic casing**  
Top view



Front view

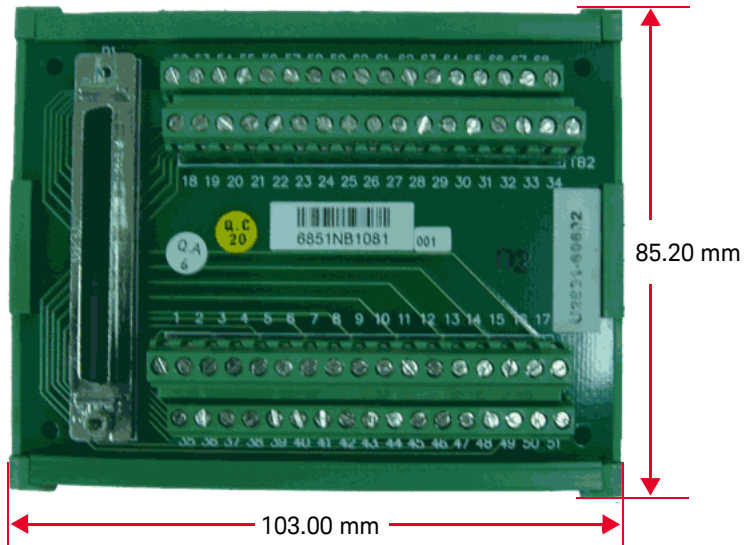


Front view

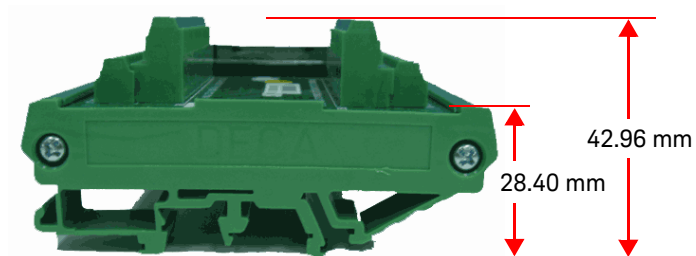


# Terminal Block Overview

Top view



Side view



## Standard Purchase Items Checklist

Inspect and verify that you have all the following items upon the purchase of your U2500A series DAQ device. If there are missing items, please contact the nearest Keysight Sales Office.

- ✓ AC/DC power adapter
- ✓ Power cord
- ✓ USB extension cable
- ✓ L-Mount kit (used with Keysight U2781A modular instrument chassis)
- ✓ Keysight USB Modular Products and Systems Quick Start Guide
- ✓ Keysight USB Modular Products and Systems Product Reference DVD-ROM
- ✓ Keysight Automation-Ready CD-ROM (contains the Keysight IO Libraries Suite)
- ✓ Certificate of Calibration

### **WARNING**

Use only power adaptor provided by manufacturer to avoid unexpected hazard.

---

## Software Installation

If you would like to use the U2500A series DAQ devices with the Keysight Measurement Manager application software, follow the step-by-step instructions as shown in the *Keysight USB Modular Products and Systems Quick Start Guide*.

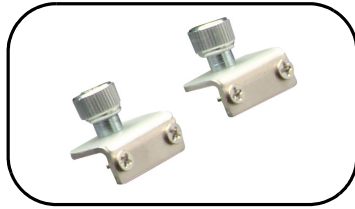
**NOTE**

You may be required to install the IVI-COM driver before using the U2500A series with other ADEs.

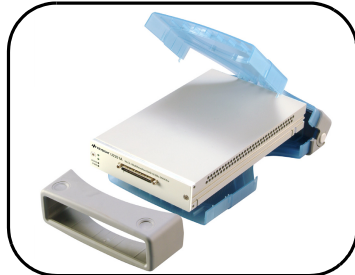
---

## L-Mount Kit Installation

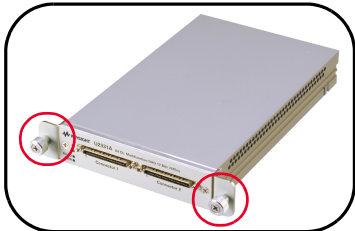
The L-Mount kit is to be used with Keysight U2781A USB modular instrument chassis. The following instructions describe simple procedures of installing the L-Mount kit to a U2600A USB devices.



**1** Unpack the L-Mount kit from the packaging.

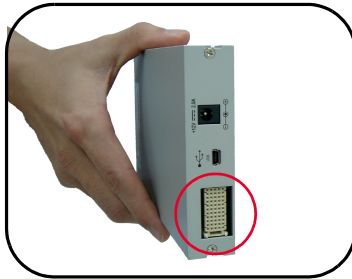


**2** Remove your USB device from its plastic casing by pulling the bumper (front end of the casing) in an outward direction. Then, lift the plastic body casing and remove it from your USB device.



**3** Using the *Philips* screw driver, screw the L-Mount kit to your USB device.





**4** To slot in the USB module to your chassis, turn your module perpendicularly and ensure that the 55-pin backplane connector is at the bottom side of the USB module.



**5** Your USB device is now ready to be plug into an instrument chassis.

## General Maintenance

**NOTE**

Repair or service which are not covered in this manual should only be performed by qualified personnel.

---

To remove the dirt or moisture from the USB device, follow the instructions below.

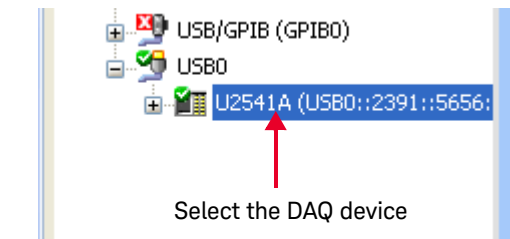
- 1** Power off the USB device and remove the AC/DC adapter cord and USB cable from your device.
- 2** Remove your USB device from its plastic casing by pulling at the bumper (front end of the casing) in an outward direction. Then, lift the plastic body casing and remove it from your USB device.
- 3** Holding your USB device, shake out any dirt that may have accumulated on the panel of your USB device.
- 4** Wipe your USB device with a dry clean cloth.

## Additional Information

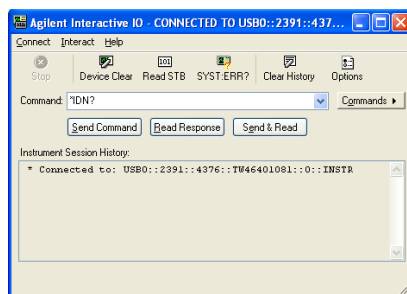
### Hardware verification

Keysight Connection Expert is one of the utilities of Keysight IO Libraries. It automatically detects the USB devices that are connected to the PC and enables communication between the USB device and the PC. To verify that your USB device has established a connection with your PC, perform the following steps.

- 1 Go to **Start > All Programs > Keysight IO Libraries Suite > Keysight Connection Expert** to launch the Keysight Connection Expert.
- 2 The connected USB device will be visible in the **Instrument I/O on this PC** panel as indicated in the following. Select the DAQ connection interface and right-click.



- 3 A context menu will appear. Click **Send Commands To This Instrument**. The Keysight Interactive IO dialog box will appear as shown below. Click **Send & Read** to send the \*IDN? default SCPI command. The instrument's response will be displayed in the **Instrument Session History** panel.



- 4 Successful communication between the PC and the connected hardware indicates successful hardware installation and connection establishment.

## Sample code

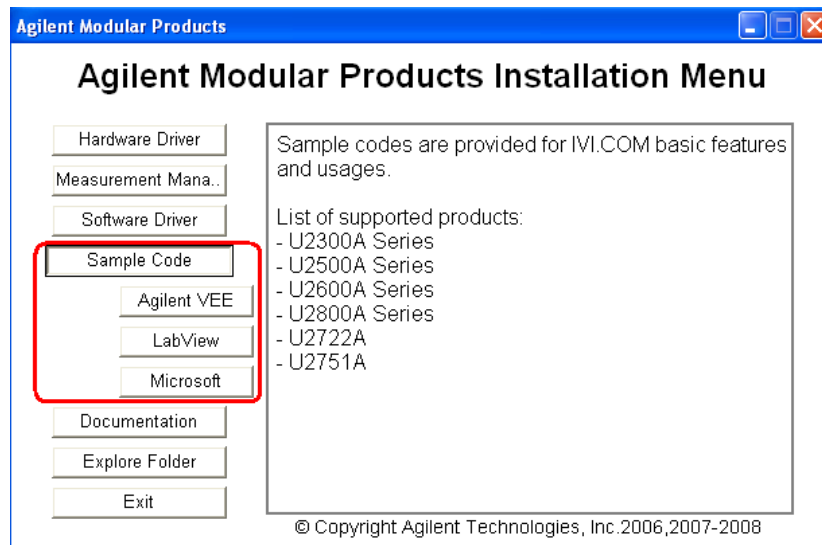
Sample codes for Keysight VEE, LabView and Microsoft (C#, C++, VB7, and VB6) are provided to help you get started and familiarized with the instrument. The sample codes provided for each language are as follows.

- **Example1**: Demonstrates the initialization of the instrument.
- **DigitalIO**: Read data from instrument and write data to instrument.
- **OneShot**: Acquire data from measurement and return it to user.
- **Counter**: Perform basic counter functionality such as configure the counter and measure frequency.
- **ArbWav**: Generation of arbitrary waveform.
- **StdWav**: Generation of standard waveform.

### To view the sample code

Select **Sample Code** on the Keysight Modular Products Installation Menu and choose the type of language.

See the following figure.



# 2 Connector Pins Configuration

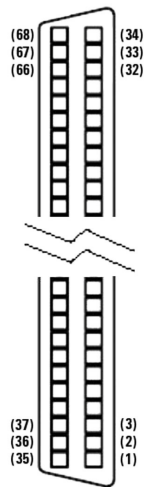
|   |    |
|---|----|
| Introduction  | 30 |
| Connector Pins Configuration for U2531A/U2541A/U2542A | 31 |
| 55-pin Connector (J1) Pins Configuration              | 33 |

This chapter describes the U2500A series USB simultaneous sampling multifunction data acquisition devices pins configuration and the 55-pin backplane connector pins configuration.

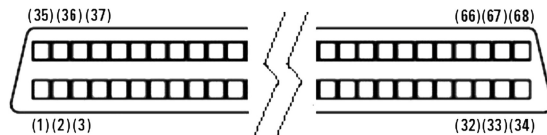
## Introduction

The U2500A series USB simultaneous sampling multifunction data acquisition (DAQ) devices were equipped with 68-pin female VHDCI type connector. The connector pins configuration for all of the U2500A series DAQ devices are provided in this chapter.

When the DAQ module is used in a modular instrument chassis (U2781A), see [Figure 2-1](#) for the pins numbering. When the DAQ module is used as a standalone unit, see [Figure 2-2](#).



**Figure 2-1** Connector in vertical view



**Figure 2-2** Connector in horizontal view

## Connector Pins Configuration for U2531A/U2541A/U2542A

|                 |       |    |                 |       |        |
|-----------------|-------|----|-----------------|-------|--------|
| AIH101          | 1     | 35 | AIL 101         |       |        |
| AIH102          | 2     | 36 | AIL 102         |       |        |
| AIH103          | 3     | 37 | AIL 103         |       |        |
| AIH104          | 4     | 38 | AIL 104         |       |        |
| EXTA_TRIG       | 5     | 39 | AI_GND          |       |        |
| AO202           | 6     | 40 | AO_GND          |       |        |
| AO201           | 7     | 41 | AO_GND          |       |        |
| AO_EXT_REF      | 8     | 42 | AO_GND          |       |        |
| RESERVED        | 9     | 43 | RESERVED        |       |        |
| RESERVED        | 10    | 44 | RESERVED        |       |        |
| RESERVED        | 11    | 45 | RESERVED        |       |        |
| RESERVED        | 12    | 46 | RESERVED        |       |        |
| RESERVED        | 13    | 47 | EXTD_AO_TRIG    |       |        |
| RESERVED        | 14    | 48 | EXTD_AI_TRIG    |       |        |
| COUNT302_CLK    | 15    | 49 | D_GND           |       |        |
| COUNT301_CLK    | 16    | 50 | D_GND           |       |        |
| COUNT301_GATE   | 17    | 51 | COUNT302_GATE   |       |        |
| COUNT301_OUT    | 18    | 52 | COUNT302_OUT    |       |        |
| COUNT301_UPDOWN | 19    | 53 | COUNT302_UPDOWN |       |        |
| EXT_TIMEBASE    | 20    | 54 | D_GND           |       |        |
| RESERVED        | 21    | 55 | RESERVED        |       |        |
| DIO502          | Bit-7 | 22 | 56              | Bit-6 | DIO502 |
|                 | Bit-5 | 23 | 57              | Bit-4 |        |
|                 | Bit-3 | 24 | 58              | Bit-2 |        |
|                 | Bit-1 | 25 | 59              | Bit-0 |        |
| DIO504          | Bit-3 | 26 | 60              | Bit-2 | DIO504 |
|                 | Bit-1 | 27 | 61              | Bit-0 |        |
|                 | D_GND | 28 | 62              | D_GND |        |
| DIO503          | Bit-3 | 29 | 63              | Bit-2 | DIO503 |
|                 | Bit-1 | 30 | 64              | Bit-0 |        |
| DIO501          | Bit-7 | 31 | 65              | Bit-6 | DIO501 |
|                 | Bit-5 | 32 | 66              | Bit-4 |        |
|                 | Bit-3 | 33 | 67              | Bit-2 |        |
|                 | Bit-1 | 34 | 68              | Bit-0 |        |

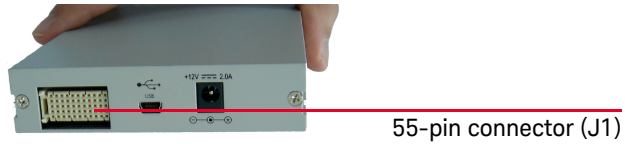
**Figure 2-3** Pins configuration for U2531A/U2541A/U2542A

**Table 2-1** Pins legend for U2531A/U2541A/U2542A

| Pin                            | Signal Name               | Direction | Reference      | Description  |
|--------------------------------|---------------------------|-----------|----------------|--|
| 1 to 4                         | AIH<101...104>            | Input     | AIL<101...104> | Differential positive input for AI channel <101...104> |
| 5                              | EXTA_TRIG                 | Input     | AI_GND         | External AI analog trigger                             |
| 6                              | AO202                     | Output    | AO_GND         | AO channel 2   |
| 7                              | AO201                     | Output    | AO_GND         | AO channel 1   |
| 8                              | AO_EXT_REF                | Input     | AO_GND         | External reference for AO channels                     |
| 9 to 12                        | RESERVED                  | Input     | N/A            | RESERVED   |
| 13, 14                         | RESERVED                  | Output    | D_GND          | RESERVED   |
| 15                             | COUNT<302>_CLK            | Input     | D_GND          | Source of counter <302>                                |
| 16                             | COUNG<301>_CLK            | Input     | D_GND          | Source of counter <301>                                |
| 17, 51                         | COUNT<301,302>_GATE       | Input     | D_GND          | Gate of counter <301,302>                              |
| 18, 52                         | COUNT<301,302>_OUT        | Input     | D_GND          | Output of counter <301,302>                            |
| 19, 53                         | COUNT<301,302>_<br>UPDOWN | Input     | D_GND          | Up/Down of counter <301,302>                           |
| 20                             | EXT_TIMEBASE              | Input     | D_GND          | External TIMEBASE                                      |
| 21, 28, 49, 50, 54, 62         | D_GND                     | N/A       | N/A            | Digital ground   |
| 22, 56, 23, 57, 24, 58, 25, 59 | DIO502<7,0>               | PIO       | D_GND          | Programmable DIO of Channel 502                        |
| 26, 60, 27, 61                 | DIO504<3,0>               | PIO       | D_GND          | Programmable DIO of Channel 504                        |
| 29, 63, 30, 64                 | DIO503<3,0>               | PIO       | D_GND          | Programmable DIO of Channel 503                        |
| 31, 65, 32, 66, 33, 67, 34, 68 | DIO501<7,0>               | PIO       | D_GND          | Programmable DIO of Channel 501                        |
| 35 to 38                       | AIL<101...104>            | Input     | N/A            | Differential negative input for AI channel<101...104>  |
| 39                             | AI_GND                    | N/A       | N/A            | Analog ground for AI                                   |
| 40 to 42                       | AO_GND                    | N/A       | N/A            | Analog ground for AO                                   |
| 43 to 46                       | RESERVED                  | Input     | N/A            | RESERVED   |
| 47                             | EXTD_AO_TRIG              | Input     | D_GND          | External AO waveform trigger                           |
| 48                             | EXTD_AI_TRIG              | Input     | D_GND          | External AI digital trigger                            |
| 21, 55                         | RESERVED                  | Input     | N/A            | RESERVED   |



## 55-pin Connector (J1) Pins Configuration



**Figure 2-4** Connector (J1) 55-pin

**Table 2-2** U2500A series J1 connector pin assignment

|    |     |       |           |       |        |          |     |
|----|-----|-------|-----------|-------|--------|----------|-----|
| 11 | GND | +12 V | +12 V     | GND   | USB_D+ | USB_D-   | GND |
| 10 | GND | +12 V | +12 V     | +12 V | GND    | GND      | GND |
| 9  | GND | +12 V | +12 V     | +12 V | GND    | USB_VBUS | GND |
| 8  | GND | LBL0  | BRSV      | GND   | TRIG0  | LBR0     | GND |
| 7  | GND | LBL1  | GA0       | TRIG7 | GND    | LBR1     | GND |
| 6  | GND | LBL2  | GA1       | GND   | TRIG1  | LBR2     | GND |
| 5  | GND | LBL3  | GA2       | TRIG6 | GND    | LBR3     | GND |
| 4  | GND | LBL4  | STAR_TRIG | GND   | TRIG2  | LBR4     | GND |
| 3  | GND | LBL5  | GND       | TRIG5 | GND    | LBR5     | GND |
| 2  | GND | LBL6  | CLK10M    | GND   | TRIG3  | LBR6     | GND |
| 1  | GND | LBL7  | GND       | TRIG4 | GND    | LBR7     | GND |
|    | Z   | A     | B         | C     | D      | E        | F   |

**Table 2-3** U2500A series J1 connector legend

| Pin                        | Descriptions               |
|----------------------------|----------------------------|
| +12 V                      | +12 V power from backplane |
| GND                        | Ground                     |
| BRSV                       | Reserved pin               |
| TRIG0 to TRIG7             | Trigger bus 0 to 7         |
| STAR_TRIG                  | Star trigger               |
| CLK10M                     | 10 MHz reference clock     |
| USB_VBUS                   | USB bused power, +5 V      |
| USB_D+, USB_D-             | USB differential pair      |
| LBL <0..7> and LBR <0...7> | Reserved pin               |
| GA0, GA1, GA2              | Geographical address pin   |

# 3 Features and Functions

|                                 |    |
|---------------------------------|----|
| Features Overview               | 36 |
| Analog Input Operation Mode     | 37 |
| Analog Output Operation Mode    | 50 |
| Digital I/O                     | 56 |
| General Purpose Digital Counter | 59 |
| Trigger Sources                 | 65 |
| SCPI Programming Examples       | 74 |

This chapter describes the features and functions of the Keysight U2500A series USB simultaneous sampling multifunction DAQ device. This includes the operations of the analog input operation mode, analog output operation mode, digital I/O and General Purpose Digital Counter. This chapter also explains the trigger sources available for the device and some SCPI examples are provided to assist you in programming.

## Features Overview

**U2531A** 14-bit analog input resolution with maximum sampling rate of 2 MSa/s

**U2541A** 16-bit analog input resolution with maximum sampling rate of 250 kSa/s

**U2542A** 16-bit analog input resolution with maximum sampling rate of 500 kSa/s

- Simultaneous sampling for analog input
- Resolution of 14-bit and 16-bit
- 4 simultaneous differential inputs (DI)
- Programmable bipolar and unipolar analog input
- Self-calibration supported
- USBTMC 488.2 compliant
- Hi-Speed USB 2.0 interface
- Multiple trigger sources†— none (immediate trigger), external analog/digital trigger, and SSI/star trigger (used with modular chassis)

## Analog Input Operation Mode

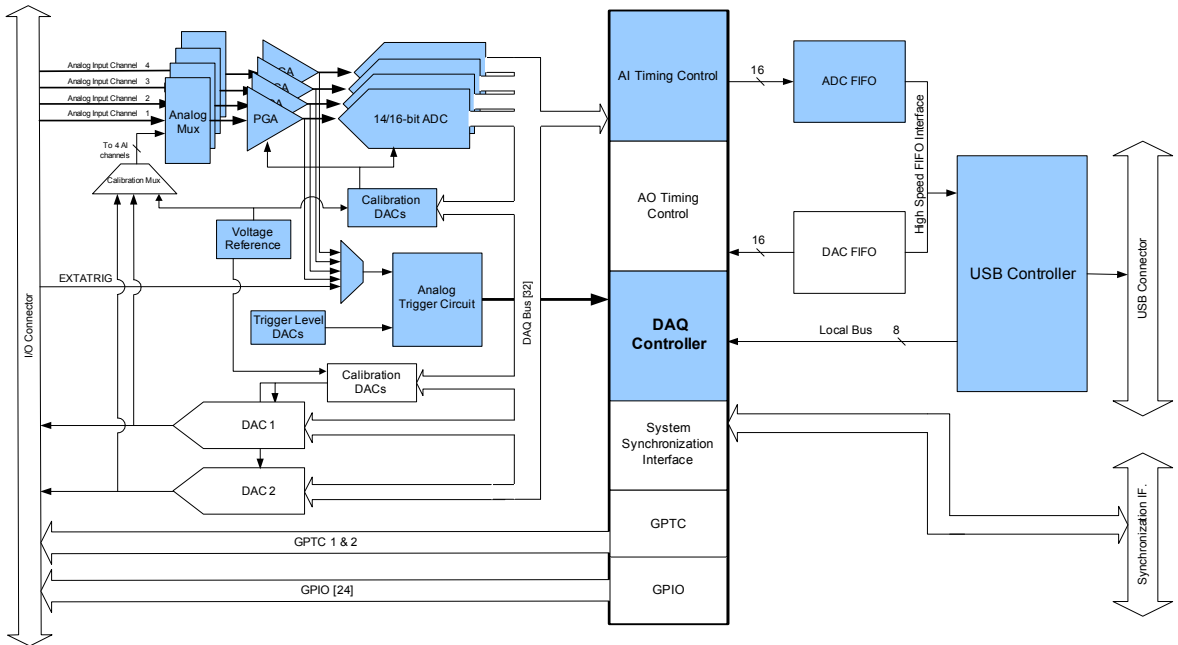
The U2500A series DAQ devices have four simultaneous sampling (SS) analog input (AI) channels with programmable sampling rate. To measure analog signals, you should define the properties of the measured signals. The properties include the mode (polling/continuous), polarity (bipolar/ unipolar), and voltage range. You may also need to set the desired channels to input the analog signals. For all the SS models, the measuring configuration is in differential (DIFF) mode.

AI operations require a trigger source. Once the trigger condition is matched, the data acquisition will start. The measured signal is buffered in a Data FIFO. The analog inputs are able to measure input voltages between  $\pm 1.25$  V to  $\pm 10$  V. The diagram in [Figure 3-1](#) illustrates the functional block diagram of the U2500A series DAQ devices.

When the U2500A series DAQ devices are switched on, the calibration constants are loaded from the on-board EEPROM to ensure both the calibration DACs and PGA circuit is functioning correctly. Referring to the functional block diagram in [Figure 3-1](#), the AI signals will firstly get to the analog multiplexer and then to the PGA. Next, it will get through the analog digital converter (ADC), where the analog voltage will be converted into digital information for computer to process or store the signals. Note that the trigger levels for the digital analog converter (DAC) have to be defined beforehand if you want to use the analog trigger.

In this section, different types of analog input modes are described. The analog to digital data conversion for 16 bits and 14 bits will also be explained with formulas (bipolar and unipolar). Finally, the AI data format for U2500A series is provided.

### 3 Features and Functions



**Figure 3-1** Functional block diagram of U2500A series DAQ device

There are two different modes of analog input operation, which are the polling and continuous.

**Table 3-1** Analog input operation overview

| Operation    | Modes           | Types of Acquisition  |
|--------------|-----------------|---|
| Analog Input | Polling Mode    | Single A/D data acquisition   |
|              | Continuous Mode | <ul style="list-style-type: none"> <li>– Single-shot acquisition</li> <li>– Continuous acquisition</li> </ul> |

## Polling mode

This is the easiest way to acquire a single A/D measurement simultaneously for four different channels. The A/D converter starts converting one reading whenever the dedicated SCPI command is executed. The SCPI command for performing the polling mode measurement is under MEASure subsystem. In this mode, the timing of the A/D conversion is fully controlled by software.

Prior to using the polling mode, the properties of the measured signal should be defined. The properties that should be defined are voltage range ( $\pm 10$  V,  $\pm 5$  V,  $\pm 2.5$  V,  $\pm 1.25$  V) and polarity (unipolar/bipolar). The default voltage range is  $\pm 10$  V and the default polarity is bipolar. These properties can be set via SCPI commands under the SOURce subsystem. The signal type for U2500A series is in differential mode (DIFF).

By default, the polling mode measurement is made once the **MEASure?** query command is received by the devices. This behavior can be altered by instructing the device to average a range of measurements prior to returning the final value to users. For example, by setting the following SCPI command

```
[SENSe]:VOLTage:AVERage 10, (@101)
```

prior to the **MEASure? (@101)** query command, the device will make ten measurements; average them and returns the average value to the users.

### NOTE

For more information on MEASure subsystem, SOURce Subsystem and [SENSe:]VOLTage, refer to the *Keysight U2500A Series USB Simultaneous Sampling Multifunction Data Acquisition Devices Programmer's Reference*.

### Example 1: Analog input polling

```
-> *CLS;*RST // To reset DAQ to default power-on state, this command can be ignored if this operation is not required
-> MEAS? (@101,102,103,104) // AI polling with default condition
<- 1.50123,5.0012,7.1234,9.1112 // Returned measurement
```

### Example 2: Analog input polling with settings

```
-> *CLS;*RST // To reset DAQ to default power-on state, this command can be ignored if this operation is not required
-> VOLT:RANG 10, (@101,103) // Set 10 V range to CH 101, 103
-> VOLT:POL UNIP, (@101,103) // Set polling to measure 100 times and return the average value
-> VOLT:AVER 100 // Set polling to measure 100 times and return the average value
-> MEAS? (@101,103) // Ask AI polling to activate on above setting with 100 measurements and return the average value
<- 1.50123,5.3212 // Returned average value of 100 measurements from each channel
```



## Continuous mode

There are two types of continuous mode, single-shot and continuous acquisition. In single-shot acquisition, the data is acquired at a specified sample points and processed once. In continuous acquisition, the process of acquiring data is continuous until a **STOP** command is sent. The SCPI commands below are used to start the acquisition process:

- Single-shot acquisition:

**DIGitize**

- Continuous acquisition:

**RUN**

In continuous mode, there are two parameters that need to be specified:

### a) Sampling rate

The maximum sampling rate depends on the ADC's sampling rate. For example, if you set the sampling rate to maximum, i.e. 500 kSa/s for U2542A, all the AI channels will sample data under the same sampling rate individually. The SCPI command to set the sampling rate for AI is:

**ACQuire:SRATe <value>**

The default sampling rate is 1 kHz.

### b) Sample points

The sample points parameter is used to set the number of acquisition points for each channel. For example, if 800 sample points is set, measuring four AI channels simultaneously will require a total of 3200 samples to be acquired. The SCPI command to set the sample points for AI is:

**ACQuire:POINts <value>**

The default sample points is 500.

**NOTE**

The maximum sample points for single-shot acquisition is 8 MSa divided by the number of channels enabled and for continuous acquisition is 4 MSa divided by the number of channels enabled.

---

**Example1: Single-shot acquisition**

```

-> *CLS;*RST // To reset DAQ to default power-on state,
              // this command can be ignored if this
              // operation is not required

-> ROUT:ENAB 1,(@101,103) // To enable acquisition on CH 101
                          // and 103

-> ROUT:CHAN:RANG 10,(@101,103) // Set 10 V range to CH 101 and 103

-> ROUT:CHAN:POL BIP,(@101,103) // Set BIPolar measuring mode to
                                // CH 101 and 103

-> ACQ:SRAT 10000 // Set acquisition with 10000 Sa/s
                  // sampling rate

-> ACQ:POIN 1000 // Set 1000 point for acquisition for
                 // each channel

-> DIG // Activate single-shot acquisition

-> WAV:COMP? // Check acquisition completion

<- NO // Acquisition is not completed yet, it
       // takes 1 sec to complete this acquisition

-> WAV:COMP? // Check acquisition completion

<- YES // Acquisition completed

-> WAV:DATA? // Fetch data back to the user's PC

<- #800004000<data><data>... // Raw data returned in binary block

```

## Example 2: Continuous acquisition

```

-> *CLS;*RST // To reset DAQ to default power-on
              state, this command can be ignored if
              this operation is not required

-> ROUT:ENAB 1, (@101,103) // To enable acquisition on channel
                           101 and 103

-> ROUT:CHAN:RANG 10, (@101,103) // Set 10 V range to CH 101 and 103
-> ROUT:CHAN:POL BIP, (@101,103) // Set BIPolar measuring mode to CH
                                   101 and 103

-> ACQ:SRAT 10000 // Set acquisition with 10000 Sa/s
                  sampling rate

-> WAV:POIN 1000 // Set 1000 Sa point for acquisition for
                 each data block

-> DIG // Activate single-shot acquisition
-> WAV:STAT? // Check acquisition status
<- FRAG // Acquisition is not completed yet, it
         takes 1 sec to complete this block of
         acquisition

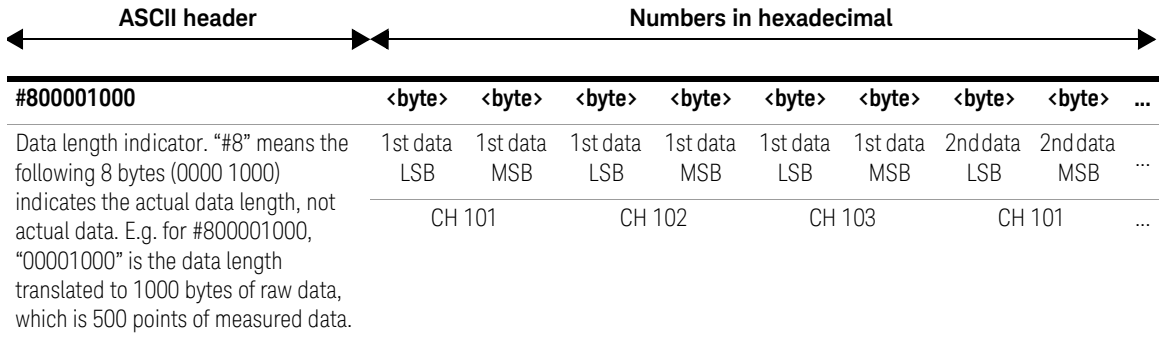
-> WAV:STAT? // Check acquisition status
<- DATA // This block of acquisition completed
-> WAV:DATA? // Fetch data back to the user's PC
<- #800004000<data><data>... // Raw data returned in binary block

```

## A/D data conversion

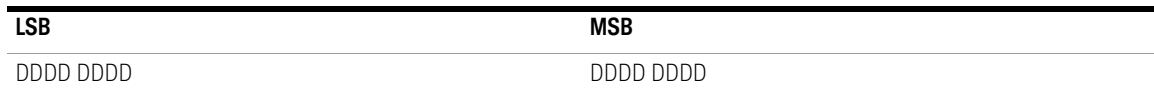
A/D data converter converts analog voltage into digital information. This section illustrates the format of acquired raw data from the A/D conversion.

The returned data is in a binary block format. Below is an example of the binary block format for three AI channels (CH 101, CH 102, and CH 103). The data arrangement in data buffer is from lower CH 101 to higher channel CH 103.



The measured samples in continuous mode acquisition is stored in Little-Endian format. In other words, each measured sample is returned in a way that its least significant byte (LSB) is ordered first; following by its most significant byte (MSB).

### 16-bit Data Format



### 14-bit Data Format



D - Data bits

X - Unused bits

## Raw data conversion

To convert the data into actual float number, we need the voltage range and polarity information. Below are the calculations on the raw data conversion for both bipolar and unipolar.

To perform a sample calculation of the conversion, take U2541A as example. Assume that the voltage level is set in the range from 0 V to 10 V for unipolar setting; and -10 V to 10 V for bipolar setting. Sample binary block is as follow.

| #800001000                       | <byte>          | <byte>          | <byte>          | <byte>          | <byte>          | <byte>          | <byte>          | <byte>          | ... |
|----------------------------------|-----------------|-----------------|-----------------|-----------------|-----------------|-----------------|-----------------|-----------------|-----|
|                                  | 1st data<br>LSB | 1st data<br>MSB | 1st data<br>LSB | 1st data<br>MSB | 1st data<br>LSB | 1st data<br>MSB | 2nd data<br>LSB | 2nd data<br>MSB | ... |
|                                  | CH 101          |                 | CH 102          |                 | CH 103          |                 | CH 101          |                 | ... |
| <b>Little Endian Format</b>      |                 |                 |                 |                 |                 |                 |                 |                 |     |
| #800001000                       | e0              | 31              | ff              | cf              | ff              | ca              | ff              | c4              |     |
| <b>Convert to Decimal Format</b> |                 |                 |                 |                 |                 |                 |                 |                 |     |
| #800001000                       | 12768           |                 | 53247           |                 | 51967           |                 | 50431           |                 |     |

The resolution for U2541A is 16 bits and the Int16 measured value return by DAQ is 12768. The binary number for 12768 is 00110001 11100000. However, since the data is stored in Little-Endian format, the 16 bits binary read back calculation will be as follow.

|                        | LSB                     | MSB                     |
|------------------------|-------------------------|-------------------------|
| <b>Hex value :</b>     | <b>e0</b>               | <b>31</b>               |
| <b>Binary value :</b>  | <b>&lt;11100000&gt;</b> | <b>&lt;00110001&gt;</b> |
| <b>Decimal value :</b> | <b>12768</b>            |                         |

### NOTE

The raw data provided by U2500A series DAQ devices is in the byte order of LSB first.

**Bipolar:**

$$\text{Converted value} = \left( \frac{2 \times \text{Int16 value}}{2^{\text{resolution}}} \right) \times \text{Range}$$

$$\text{Example of converted value} = \left( \frac{2 \times 12768}{2^{16}} \right) \times 10 = 3.896 \text{ V}$$

**Unipolar:**

$$\text{Converted value} = \left( \frac{\text{Int16 value}}{2^{\text{resolution}}} + 0.5 \right) \times \text{Range}$$

$$\text{Example of converted value} = \left( \frac{12768}{2^{16}} + 0.5 \right) \times 10 = 6.948 \text{ V}$$

**NOTE**

The converted value is of float type. As such, you may need to type cast the Int16 value to float in your programming environment.

To perform a sample calculation of the conversion, take U2531A as example. Assume that the voltage level is set in the range from 0 V to 10 V for unipolar setting; and -10 V to 10 V for bipolar setting.

The resolution for U2531A is 14 bits and the Int12 measured value return by DAQ is 12768. The binary number for 12768 is 00110001 11100000. However, since the data is stored in Little-Endian format, the 14 bits binary read back calculation will be as follow.

|                        | <b>LSB</b>              | <b>MSB</b>              |
|------------------------|-------------------------|-------------------------|
| <b>Hex value :</b>     | <b>e0</b>               | <b>31</b>               |
| <b>Binary value :</b>  | <b>&lt;11100000&gt;</b> | <b>&lt;00110001&gt;</b> |
| <b>Decimal value :</b> | <b>12768</b>            |                         |

There are unused bits in the 14-bit data format. Therefore, there is a need to perform a 2-bit right shift operation. Hence, the 14 bits binary read back calculation will be as follows.

$$\begin{array}{cc} \text{LSB} & \text{MSB} \\ \langle 01111100 \rangle & \langle 00001100 \rangle \\ = 3192 & \end{array}$$

**NOTE**

The raw data provided by U2500A series DAQ devices is in the byte order of LSB first.

**Bipolar:**

$$\text{Converted value} = \left( \frac{2 \times \text{Int16 value}}{2^{\text{resolution}}} \right) \times \text{Range}$$

$$\text{Example of converted value} = \left( \frac{2 \times 3192}{2^{14}} \right) \times 10 = 3.896 \text{ V}$$

**Unipolar:**

$$\text{Converted value} = \left( \frac{\text{Int16 value}}{2^{\text{resolution}}} + 0.5 \right) \times \text{Range}$$

$$\text{Example of converted value} = \left( \frac{3192}{2^{14}} + 0.5 \right) \times 10 = 6.948 \text{ V}$$

**NOTE**

- The converted value is of float type. As such, you may need to type cast the Int14 value to float in your programming environment.
- For U2531A, there is a need to perform a 2-bit right shift operation. This is because it is equipped with 14-bit ADC and the last 2 bits are truncated.

## AI data format

**14-bit AI range**

The following tables 3-2 and 3-3 describe the U2531A ideal transfer characteristics of the bipolar and unipolar analog input ranges. The digital code number is two complement number.

**Table 3-2** Analog input range and digital code output for bipolar

| Description                 | Bipolar analog input range |          |           |           | Digital code output |
|-----------------------------|----------------------------|----------|-----------|-----------|---------------------|
| Full-scale Range (FSR)      | ±10 V                      | ±5 V     | ±2.5 V    | ±1.25 V   |                     |
| Least significant bit (LSB) | 1.22 mV                    | 0.61 mV  | 0.305 mV  | 0.153 mV  |                     |
| FSR-1LSB                    | 9.9988 V                   | 4.9994 V | 2.4997 V  | 1.2499 V  | 1FFF                |
| Midscale+1LSB               | 1.22 mV                    | 0.61 mV  | 0.305 mV  | 0.153 mV  | 0001                |
| Midscale                    | 0 V                        | 0 V      | 0 V       | 0 V       | 0000                |
| Midscale-1LSB               | -1.22 mV                   | -0.61 mV | -0.305 mV | -0.153 mV | 3FFF                |
| -FSR                        | -10 V                      | -5 V     | -2.5 V    | -1.25 V   | 2000                |

**Table 3-3** Analog input range and digital code output for unipolar

| Description                 | Unipolar analog input range |             |               |             | Digital code output |
|-----------------------------|-----------------------------|-------------|---------------|-------------|---------------------|
| Full-scale Range (FSR)      | 0 V to 10 V                 | 0 V to +5 V | 0 V to +2.5 V | 0 to 1.25 V |                     |
| Least significant bit (LSB) | 0.61 mV                     | 0.305 mV    | 0.153 mV      | 76.3 μV     |                     |
| FSR-1LSB                    | 9.9994 V                    | 4.9997 V    | 2.9999 V      | 1.2499 V    | 1FFF                |
| Midscale+1LSB               | 5.00061 V                   | 2.50031 V   | 1.25015 V     | 625.08 mV   | 0001                |
| Midscale                    | 5 V                         | 2.5 V       | 1.25 V        | 625 mV      | 0000                |
| Midscale-1LSB               | 4.99939 V                   | 2.49970 V   | 1.24985 V     | 624.92 mV   | 3FFF                |
| -FSR                        | 0 V                         | 0 V         | 0 V           | 0 V         | 2000                |



## 16-bit AI range

The following tables 3-4 and 3-5 describe the ideal transfer characteristics of bipolar and unipolar input ranges of U2541A and U2542A models.

**Table 3-4** Analog input range and digital code output for bipolar

| Description                 | Bipolar analog input range |                |               |                | Digital code output |
|-----------------------------|----------------------------|----------------|---------------|----------------|---------------------|
|                             | $\pm 10$ V                 | $\pm 5$ V      | $\pm 2.5$ V   | $\pm 1.25$ V   |                     |
| Full-scale Range (FSR)      | $\pm 10$ V                 | $\pm 5$ V      | $\pm 2.5$ V   | $\pm 1.25$ V   |                     |
| Least significant bit (LSB) | 305.2 $\mu$ V              | 152.6 $\mu$ V  | 76.3 $\mu$ V  | 38.15 $\mu$ V  |                     |
| FSR-1LSB                    | 9.999695 V                 | 4.999847 V     | 2.499924 V    | 1.249962 V     | 7FFF                |
| Midscale+1LSB               | 305.2 $\mu$ V              | 152.6 $\mu$ V  | 76.3 $\mu$ V  | 38.15 $\mu$ V  | 0001                |
| Midscale                    | 0 V                        | 0 V            | 0 V           | 0 V            | 0000                |
| Midscale-1LSB               | -305.2 $\mu$ V             | -152.6 $\mu$ V | -76.3 $\mu$ V | -38.15 $\mu$ V | FFFF                |
| -FSR                        | -10 V                      | -5 V           | -2.5 V        | -1.25 V        | 8000                |

**Table 3-5** Analog input range and digital code output for unipolar

| Description                 | Unipolar analog input range |              |               |                | Digital code output |
|-----------------------------|-----------------------------|--------------|---------------|----------------|---------------------|
|                             | 0 V to 10 V                 | 0 V to +5 V  | 0 V to +2.5 V | 0 V to +1.25 V |                     |
| Full-scale Range (FSR)      | 0 V to 10 V                 | 0 V to +5 V  | 0 V to +2.5 V | 0 V to +1.25 V |                     |
| Least significant bit (LSB) | 152.6 $\mu$ V               | 76.3 $\mu$ V | 38.15 $\mu$ V | 19.07 $\mu$ V  |                     |
| FSR-1LSB                    | 9.999847 V                  | 4.999924 V   | 2.499962 V    | 1.249981 V     | 7FFF                |
| Midscale+1LSB               | 5.000153 V                  | 2.500076 V   | 1.250038 V    | 0.625019 V     | 0001                |
| Midscale                    | 5 V                         | 2.5 V        | 1.25 V        | 0.625 V        | 0000                |
| Midscale-1LSB               | 4.999847 V                  | 2.499924 V   | 1.249962 V    | 0.624981 V     | FFFF                |
| -FSR                        | 0 V                         | 0 V          | 0 V           | 0 V            | 8000                |

## Analog Output Operation Mode

There are two analog output (AO) channels (12 bits) available in the U2500A series DAQ devices. The two analog outputs are capable of supplying output voltages in the range of 0 to 10 V and  $\pm 10$  V. Each DAC channel drives a maximum current of 5 mA. The two analog outputs can be used as voltage sources to your devices under test (DUT). In addition, the analog outputs are equipped with predefined function generators or any arbitrary waveform.

Analog output operation mode consists of voltage output and continuous output. The continuous output mode provided with two functions, which are function generator and arbitrary. The U2500A series DAQ is capable to generate sinusoidal, square, triangle, sawtooth waveforms and noise.

**Table 3-6** Analog output operation overview

| Operation     | Modes                 | Types of Output  |
|---------------|-----------------------|--|
| Analog Output | Single Voltage Output | DC Voltage Output  |
|               | Continuous Output     | <ul style="list-style-type: none"> <li>- Pre-defined Waveform               <ul style="list-style-type: none"> <li>- Sine wave</li> <li>- Square wave</li> <li>- Triangle wave</li> <li>- Sawtooth wave</li> <li>- Noise wave</li> </ul> </li> <li>- Arbitrary Wave</li> </ul> |

### Single voltage output mode

The following SCPI commands perform sample output of a DC voltage level for the specified DA channels.

**Example 1, To output a DC voltage via CH 201**

```

-> *CLS;*RST // To reset DAQ to default power-on
state, this command can be ignored if
this operation is not required

-> SOUR:VOLT 2.5, (@201) // Reference is AO_GND
-> SOUR:VOLT 3.2, (@201) // Changes output from 2.5 VDC to
3.2 VDC
-> SOUR:VOLT -3.2, (@201) // Changes output from 2.5 VDC to
-3.2 VDC
-> SOUR:VOLT? (@202) // To query the state of CH 202
<- 0 // By default, CH 202 is 0 VDC

```

**Example 2, To output two DC voltages via CH 201 and CH 202**

```

-> *CLS;*RST // To reset DAQ to default power-on
state, this command can be ignored if
this operation is not required

-> SOUR:VOLT 3.5, (@201) // Set 3.5 VDC output to CH 201
-> SOUR:VOLT 8.1, (@202) // Set 8.1 VDC output to CH 202

```

**Continuous output mode**

The continuous output mode consists of function generator and arbitrary. You can use the following SCPI commands in arbitrary mode:

DATA[:USER]

APPLY:USER

**NOTE**

For further information, refer to the *Keysight U2500A Series USB Simultaneous Sampling Multifunction Data Acquisition Devices Programming Guide*.

**Example 3, To output a sine wave via CH 201**

```

-> *CLS;*RST // To reset DAQ to default power-on
               state, this command can be ignored if
               this operation is not required

-> ROUT:ENAB ON, (@201) // Enable CH 201

-> APPL:SIN 5,0, (@201) // Sine wave with 5 Vp (10 Vpp) and
                       0 VDC offset

-> SYST:ERR? // To check for any error, this command
             can be ignored if this operations is not
             required

<- +0, "No Error"

-> OUTP ON // Turn on output

-> OUTP:WAV:FREQ? (@201)

<- 4000 // Default output waveform is at 4 kHz

-> OUTP OFF // Turn off output (both CH 201 and
            CH 202 at 0 VDC)

-> OUTP:WAV:FREQ 5000 // Change output frequency to 5 kHz

-> OUTP ON // Turn on output

```

**Example 4, To output a sine wave and square wave via CH 201 and CH 202 respectively**

```

-> *CLS;*RST // To reset DAQ to default power-on
               state, this command can be ignored if
               this operation is not required

-> ROUT:ENAB ON, (@201,202) // Enable CH 201 and CH 202

-> APPL:SIN 5,0, (@201) // Sine wave with 5 Vp (10 Vpp) and
                       0 VDC offset

-> APPL:SQU 3,-1, (@202) // Square wave with 3 Vp (6 Vpp) and
                       -1 VDC offset

```

```

-> OUTP:WAV:FREQ 3500           // Set both channel's output to 3.5 kHz
-> SYST:ERR?
<- +0, "No Error"             // To check for any error, this command
                                can be ignored if this operations is not
                                required
-> OUTP ON                       // Turn on output

```

## D/A reference voltage

By default, the internal reference voltage is 10 V. However, external reference can be supplied through the external reference input pin (AO\_EXT\_REF). The range of the DAC output is directly related to the reference. The analog output voltage can be generated by multiplying the digital codes that are updated with the 10 V as internal reference. Therefore, when 10 V is taken as the internal reference, the full range would be -10 V to +9.9951 V in bipolar output mode, and 0 V to 9.9976 V in unipolar output mode.

While using an external reference, the different output voltage ranges can be achieved by connecting different reference voltage. For example, if connecting a 5 VDC with the external reference (AO\_EXT\_REF), then the range from -4.9976 V to +5 V in the bipolar output can be achieved. The tables below illustrates the relationship between digital code and output voltages.

## AO data format

Data format for single channels arbitrary AO (when either one channel is enabled and USER mode) is shown in the following table.

| #800001000  | <byte>          | <byte>          | <byte>          | <byte>          | <byte>          | <byte>          | <byte>          | <byte>          | <byte> | ... |
|---|-----------------|-----------------|-----------------|-----------------|-----------------|-----------------|-----------------|-----------------|--------|-----|
| Data length indicator. “#8” means the following 8 bytes (0000 1000) indicates the actual data length, not actual data. E.g. for #800001000, “00001000” is the data length translated to 1000 bytes of raw data, which is 500 points of output data. | 1st data<br>LSB | 1st data<br>MSB | 2nd data<br>LSB | 2nd data<br>MSB | 3rd data<br>LSB | 3rd data<br>MSB | 4th data<br>LSB | 4th data<br>MSB | ...    | ... |
|   | CH 201 or 202   |                 | CH 201 or 202   |                 | CH 201 or 202   |                 | CH 201 or 202   |                 | ...    | ... |

Data format for two channels arbitrary AO (when two channels are enabled and USER mode) is shown in the following table.

| #800001000  | <byte>          | <byte>          | <byte>          | <byte>          | <byte>          | <byte>          | <byte>          | <byte>          | <byte> | ... |
|---|-----------------|-----------------|-----------------|-----------------|-----------------|-----------------|-----------------|-----------------|--------|-----|
| Data length indicator. “#8” means the following 8 bytes (0000 1000) indicates the actual data length, not actual data. E.g. for #800001000, “00001000” is the data length translated to 1000 bytes of raw data, which is 500 points of output data. | 1st data<br>LSB | 1st data<br>MSB | 1st data<br>LSB | 1st data<br>MSB | 2nd data<br>LSB | 2nd data<br>MSB | 2nd data<br>LSB | 2nd data<br>MSB | ...    | ... |
|   | CH 201          |                 | CH 202          |                 | CH 201          |                 | CH 202          |                 | ...    | ... |

## 12-bit data format

| LSB       | MSB       |
|-----------|-----------|
| DDDD DDDD | XXXX DDDD |

D - Data bits

X - Unused bits

**Table 3-7** Digital code and voltage output table for bipolar setting (U2531A, U2541A and U2542A)

| Digital Code (Hex) | Analog Output           | Voltage output (with internal reference of +10 V) |
|--------------------|-------------------------|---|
| 0x0FFF             | $V_{ref} * (2047/2048)$ | 9.9951 V  |
| 0x0801             | $V_{ref} * (1/2048)$    | 0.0048 V  |
| 0x0800             | 0 V                     | 0.0000 V  |
| 0x07FF             | $-V_{ref} * (1/2048)$   | -0.0048 V   |
| 0x0000             | $-V_{ref}$              | -10.000 V   |

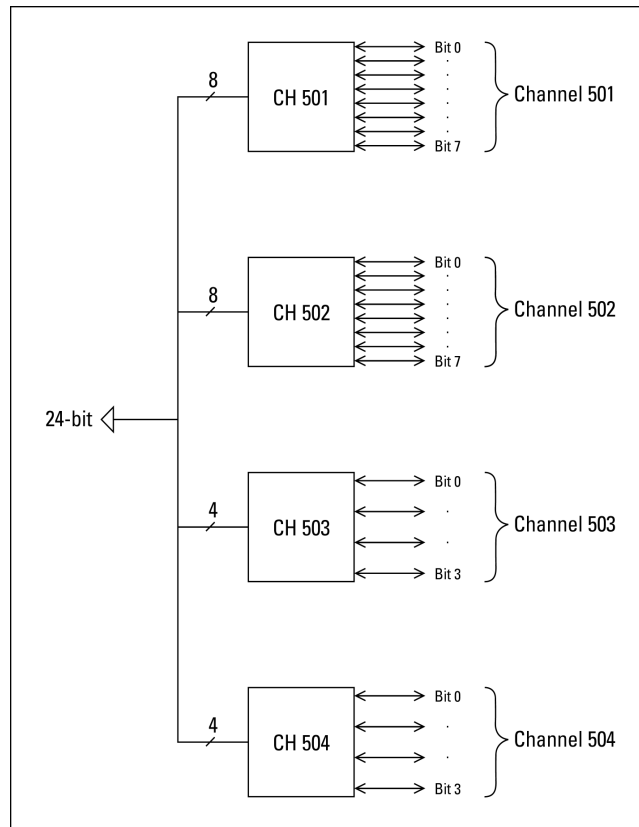
**Table 3-8** Digital code and voltage output table for unipolar setting (U2531A, U2541A and U2542A)

| Digital Code (Hex) | Analog Output           | Voltage output (with internal reference of +10 V) |
|--------------------|-------------------------|---|
| 0x0FFF             | $V_{ref} * (4095/4096)$ | 9.9976 V  |
| 0x0800             | $V_{ref} * (2048/4096)$ | 5.000 V   |
| 0x0001             | $V_{ref} * (1/4096)$    | 0.0024 V  |
| 0x0000             | $V_{ref} * (0/4096)$    | 0.000 V   |

## Digital I/O

The U2500A series DAQ provides 24-bit of general purpose digital I/O (GPIO), which is TTL compatible.

The 24-bit GPIO are segmented into four channels (CH 501 to 504). Channel 501 and 502 consists of eight data bit while Channel 503 and 504 consists of four data bit. All four channels are programmable as input and output. As the system starts up and reset, all the I/O pins are reset to the input configuration and in high impedance.



**Figure 3-2** General purpose digital counter I/O of U2500A series DAQ device



The SCPI programming examples below will help you to configure the DIO and read a digital channel.

### Configure the digital channel as OUTPUT and query/verify the output pattern data

#### Example 1:

```
-> CONF:DIG:DIR OUTP, (@501)
-> SOUR:DIG:DATA 123, (@501)
-> SOUR:DIG:DATA? (@501)
<- 123
```

#### Example 2:

```
-> CONF:DIG:DIR OUTP, (@502) // Configure the CH 502 to digital
                               output state
-> SOUR:DIG:DATA:BIT 1,4, (@502) // To set bit 4 of channel 502 to
                                   1 immediately
-> SOUR:DIG:DATA:BIT? 4, (@502) // Query status of bit 4 of CH 502
<- 1
```

### Configure the digital channel to INPUT and read back the value

#### Example 1:

```
-> CONF:DIG:DIR INP, (@501) // Configure the CH 501 to digital input
                               state
-> MEAS:DIG? (@501) // To read back the digital value at
                               channel 501
<- 23
```

## Example 2:

```

-> CONF:DIG:DIR INP, (@501)           // To read the logic state of bit 3 of
                                        channel 501
-> MEAS:DIG:BIT? 3, (@501)
<- 0

```

**NOTE**

Input commands are not allow when channel is in Output mode, while output commands are not allow when channel is in Input mode.

## Example 3:

```

-> CONF:DIG:DIR OUTP, (@501, 503)
-> CONF:DIG:DIR INP, (@502, 504)
-> CONF:DIG:DIR? (@501:504)
<- OUTP, INP, OUTP, INP
-> MEAS:DIG? (@501)                   // CH 501 has been set to output state,
                                        hence, it cannot perform input activity
<- ! VI_ERROR_TMO: A timeout occurred
-> SOUR:DIG:DATA? (@502)              // CH 502 has been set to input state,
                                        hence, it cannot perform output
                                        activity
<- ! VI_ERROR_TMO: A timeout occurred

```

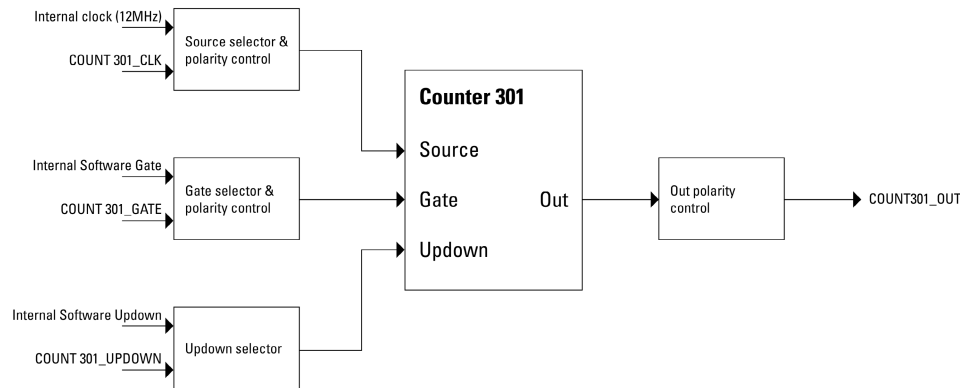
## General Purpose Digital Counter

The U2500A series DAQ device has two independent 31-bit up/down counters to measure the input channels, which is TTL compatible. It has a programmable counter clock up to 12 MHz or clock generation. Refer to the following figure for further illustration.

The counter is designed with the following features:

- Count up/down capability
- Internal/external programmable counter clock source up to 12 MHz
- Programmable gate selection which can be triggered internally or externally
- Pre-loaded software initial count for Totalizer
- Read-back capability of current count, without affecting the counting process

This digital counter operates in two modes; totalizer and measurement modes.



**Figure 3-3** General purpose digital counter

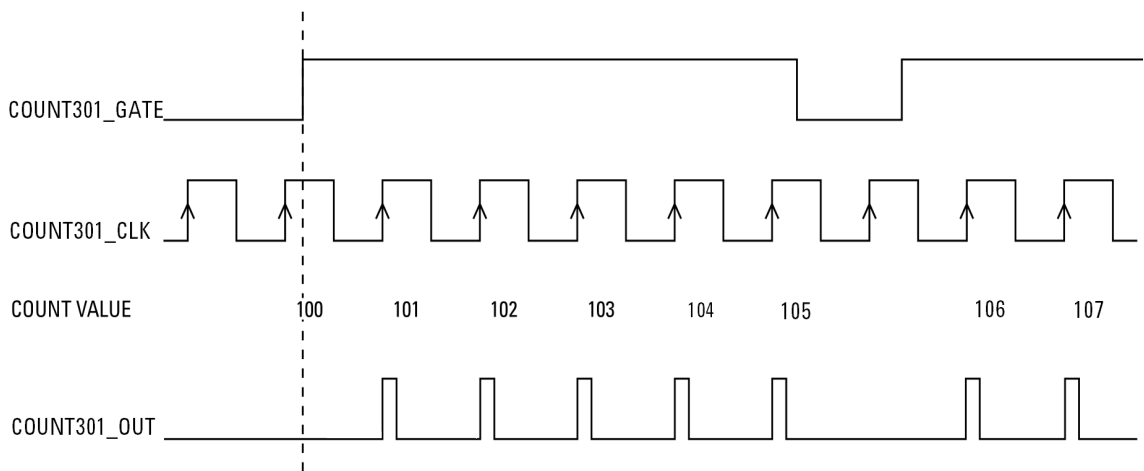
### Totalizer mode

In totalizer mode, the counter will start counting the number of pulses generated on COUNT\_CLK. This is done after the GATE is enabled. The totalize count is measured with the following command:

```
MEASure:COUNTER:TOTAlize? (@301)
```

The example below illustrates the count up mode when the counter is configured as Totalize with initial count set to 0.

COUNT\_GATE will enable the counting after Totalize function has been enabled and the COUNT\_OUT pin will output a series of pulses as shown below.



**Figure 3-4** Totalizer mode

#### NOTE

The output pulse width is at 20.8 ns.

The following SCPI programming example shows how to set the counter mode.

```

// Supply the signal to COUNT301_CLK
// Counter mode setting
-> COUN:FUNC TOT, (@301)           // Set as Totalize function
-> COUN:GATE:SOUR INT, (@301)     // Set the GATE source as internal
-> COUN:CLK:POL AHI, (@301)      // Set the clock polarity as active high
-> COUN:CLK:SOUR EXT, (@301)     // Set the clock source as external
-> COUN:TOT:IVAL 100, (@301)     // Initial Count value
-> COUN:TOT:UDOW:DIR UP, (@301)  // Set as Count Upmode
-> COUN:TOT:UDOW:SOUR INT, (@301) // Set the Up/Down source as internal
-> SOUR:COUN:OUTP:POL AHI, (@301)
-> COUN:TOT:INIT (@301)          // Initiate Totalize
-> MEAS:COUN:TOT? (@301)        // Initial value = 100
<- 100
-> MEAS:COUN:DATA? (@301)       // Return Totalize value
<- 100
-> COUN:GATE:CONT ENAB, (@301)   // Start Counting (for INT gate only)
-> COUN:GATE:CONT DIS, (@301)   // Stop Counting (for INT gate only)
-> MEAS:COUN:TOT? (@301)
<- 105
-> MEAS:COUN:DATA? (@301)
<- 105
-> COUN:ABOR (@301)             // Abort all counter operation
-> COUN:TOT:CLE (@301)         // Clear Count value
-> MEAS:COUN:TOT? (@301)
<- 0
-> MEAS:COUN:DATA? (@301)
<- 0

```

### Measurement mode

In the measurement mode, frequency, period and pulse width are measured. The intended measurement signal should be ported into COUNT301\_GATE.

The gate source is set using the command below:

```
[SENSe:]COUNter:GATE:SOURce
```

Since all three measurements are derived from the same basic measurement, the measured frequency, period and pulse width can be easily retrieved from commands below:

```
MEAS:COUN:FREQ? (@<ch_list>
```

```
MEAS:COUN:PER? (@<ch_list>
```

```
MEAS:COUN:PWID? (@<ch_list>
```

The return value for frequency, period and pulse width measurements is a floating value.

#### NOTE

- The input frequency measurable range is from 0.1 Hz to 6 MHz, where measurement frequency resolution is:
    - 12 MHz/n, n = 2, 3, 4, 5, ..., 120M
    - = 6 MHz, 4 MHz, 3 MHz, 2.4 MHz, 2.0 MHz, ..., 0.1 Hz (up to six decimal points)
  - The pulse width measurement is in the range of 0.167 s to 178.956 s.
-

The following SCPI programming examples are for frequency, period and pulse width measurements.

### Example 1:

```

// Supply the signal to COUNT301_GATE
// Counter mode setting
// Take 5.5 kHz with 70% duty cycle square wave as measurement
-> COUN:GATE:SOUR EXT, (@301)
-> COUN:GATE:POL AHI, (@301)
-> COUN:CLK:POL AHI, (@301)
-> COUN:CLK:SOUR INT, (@301)
-> COUN:CLK:INT?
<- 12000
-> SOUR:COUN:OUTP:POL AHI, (@301)
-> COUN:FUNC FREQ, (@301)
-> MEAS:COUN:DATA? (@301) // Return value depend on function set
<- 5.499542 // Frequency in kHz
-> COUN:FUNC PER, (@301)
-> MEAS:COUN:DATA? (@301)
<- 0.1818333 // Period in ms
-> COUN:FUNC PWID, (@301)
-> MEAS:COUN:DATA? (@301)
<- 0.12725 // Pulse width in ms
-> MEAS:COUN:FREQ? (@301)
<- 5.499542
-> COUN:FUNC? (@301)
<- FREQ // Function automatic set to FREQ

```

```
-> MEAS:COUN:PER? (@301)
<- 0.1818333
-> COUN:FUNC? (@301)
<- PER // Function automatic set to PER
-> MEAS:COUN:PWID? (@301)
<- 0.12725
-> COUN:FUNC? (@301)
<- PWID // Function automatic set to PWID
```

**Example 2:**

```
// Assume 10 MHz external Clock for FREQ,PER,PWID measurement
-> COUN:CLK:SOUR EXT, (@301) // Must set the external Clock value
                             (KHz)
-> COUN:CLK:EXT 10000, (@301)
-> COUN:CLK:EXT? (@301)
<- 10000
```

**NOTE**

Direction of the counter and the initial value of the counter are not important for this mode.

---



## Trigger Sources

The Keysight U2500A series USB DAQ devices provide flexible trigger options for various applications. There are four types of trigger sources:

- none (immediate trigger)
- digital trigger
- analog trigger
- star trigger

Users can configure the trigger source for A/D and D/A operations remotely.

### NOTE

- The D/A and A/D conversions share the same analog trigger.
- Star trigger is used when the DAQ is connected into the modular instrument chassis.

All four types of trigger sources are summarized in the following tables.

**Table 3-9** Trigger type for single-shot acquisition of continuous mode

| Trigger Source           | Type                          | Condition                   | Pin Selection                            |
|--------------------------|-------------------------------|-----------------------------|--|
| None (immediate trigger) | - Post<br>- Delay             | N/A                         | N/A                                      |
| Digital trigger          | - Pre                         | Positive/Negative           | EXTD_AI_TRIG, EXTD_AO_TRIG               |
| Analog trigger           | - Middle<br>- Post<br>- Delay | Above High/Below Low/Window | EXTA_TRIG, CH101, CH102,<br>CH103, CH104 |

**Table 3-10** Trigger type for continuous acquisition of continuous mode

| Trigger Source           | Type              | Condition                   | Pin Selection                            |
|--------------------------|-------------------|-----------------------------|--|
| None (immediate trigger) |                   | N/A                         | N/A                                      |
| Digital trigger          | - Post<br>- Delay | Positive/Negative           | EXTD_AI_TRIG, EXTD_AO_TRIG               |
| Analog trigger           |                   | Above High/Below Low/Window | EXTA_TRIG, CH101, CH102,<br>CH103, CH104 |

## Trigger types

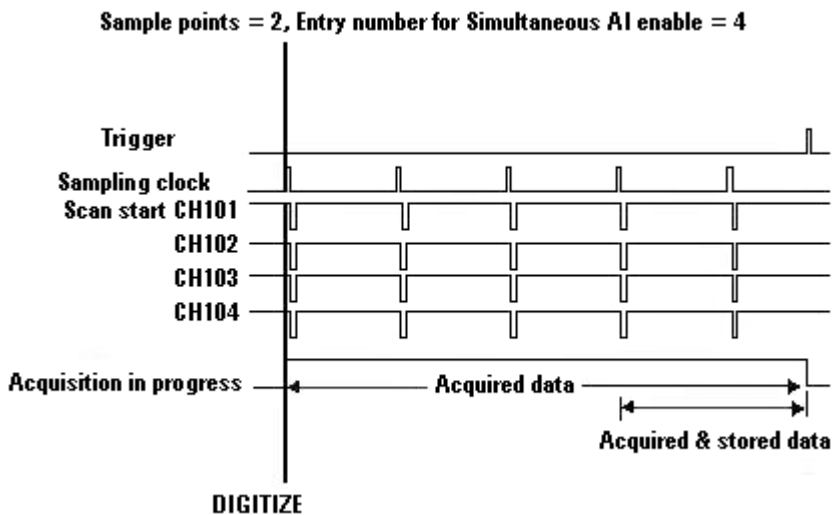
There are four types of trigger, which are pre-trigger, post-trigger, middle-trigger and delay-trigger.

### Pre-trigger

This trigger type is used when you wish to collect data before a trigger event. The A/D conversion starts when you execute the specified function calls and stops when the trigger event occurs. For example, you specify four sample points and the analog trigger occurs after four sample points are converted. The SCPI command used to set the trigger type as pre-trigger is:

```
TRIG:TYPE PRE
```

Refer to [Figure 3-5](#) for further illustration.



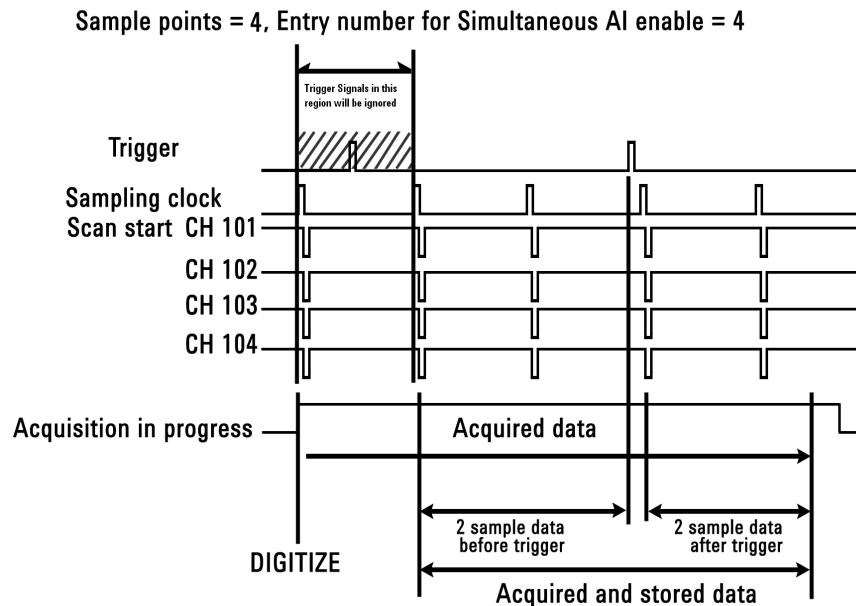
**Figure 3-5** Pre-trigger

## Middle-trigger

This trigger type is used when you want to collect data before and after a trigger event. The sampled data are equal before and after trigger. For example, if the user specify four sample points, the conversion only begins after the trigger event occurs. Two sample points before and after the trigger are taken. The SCPI command used to set the trigger type as middle-trigger is:

**TRIG:TYPE MID**

Refer to [Figure 3-6](#) for further illustration.



**Figure 3-6** Middle-trigger

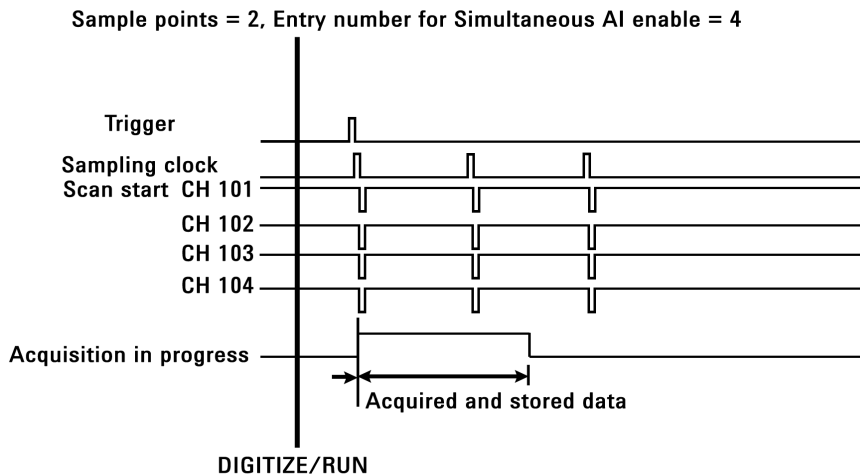
### Post-trigger

The post-trigger is the default setting and used in applications when you want to collect data after a trigger event. As illustrated in the following figure, the sample points are set to two. Total of two sample points are taken after the trigger starts.

The SCPI command used to set the trigger type as post-trigger is:

**TRIG:TYPE POST**

Refer to [Figure 3-7](#) for further illustration.

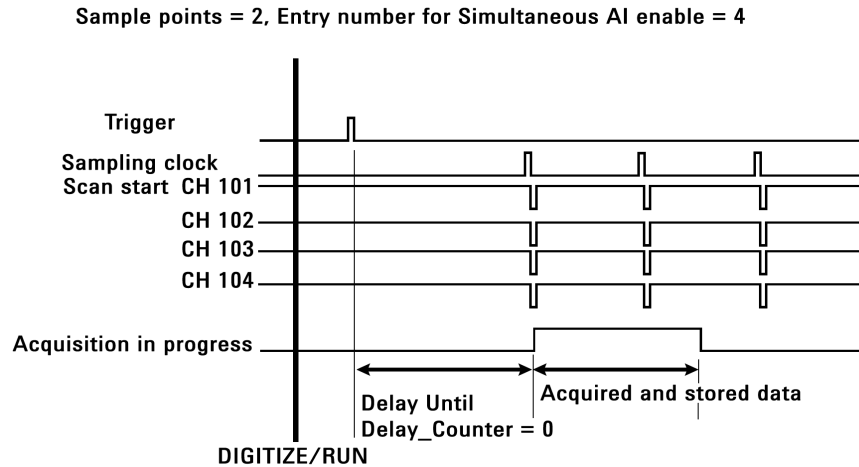


**Figure 3-7** Post-trigger

## Delay-trigger

This trigger acquisition is used in applications if you want to delay the data collecting process after a specified trigger event. The delay time is controlled by the value, which is pre-loaded in the Delay\_counter (31-bit). The clock source is the Timebase clock. When the count reaches zero, the counter stops and the board start to acquire data. When the internal 48 MHz is set as Timebase clock, the delay time is in the range of 20.8 ns to 89.47 s. If the Timebase clock is from external clock (48 MHz to 1 MHz), the delay time can be varied by user's setting.

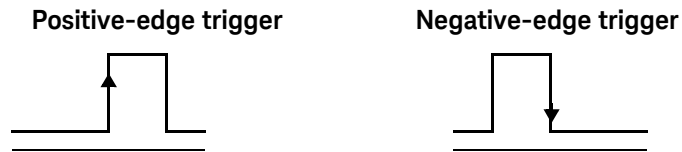
Refer to [Figure 3-8](#) for further illustration.



**Figure 3-8** Delay-trigger

## Digital trigger

There are positive and negative conditions in digital trigger. It is used when a rising or falling edge is detected on the digital signal. Positive condition is used when it triggers from low to high, while high to low when the negative condition is used.



**Figure 3-9** Positive and negative edge of digital trigger

## Analog trigger

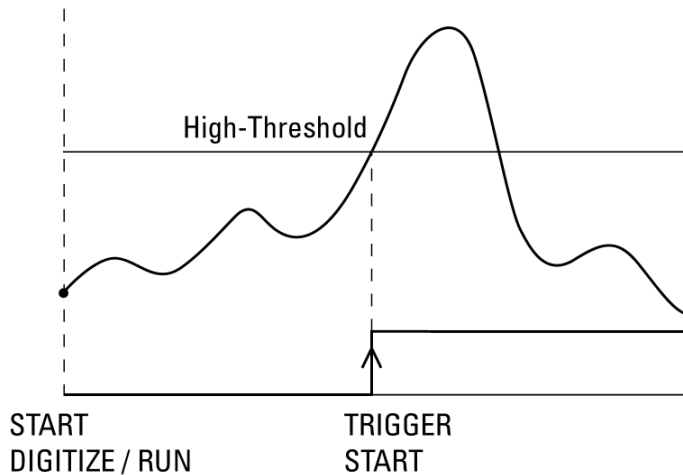
There are three analog trigger conditions in U2500A series DAQ and the trigger conditions are as follows:

- Above high
- Below low
- Window

It uses two threshold voltages, which are Low-Threshold and High-Threshold. Users can easily configure the analog trigger conditions using the Keysight Measurement Manager software.

### Above high

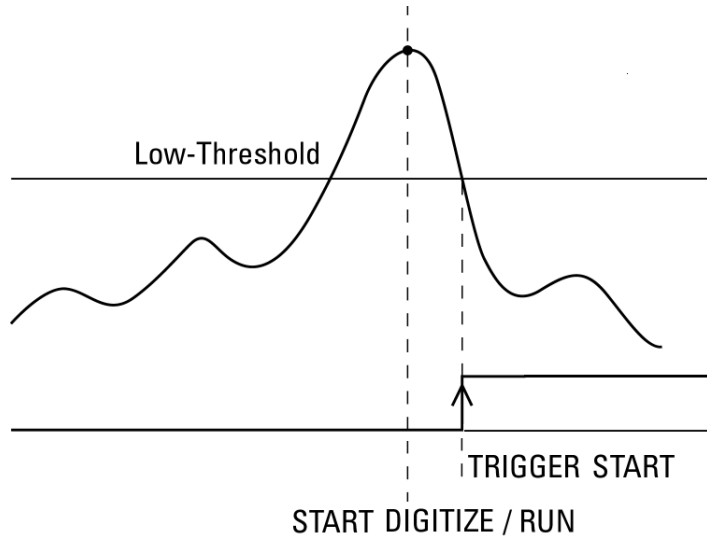
The following figure illustrates the above high analog trigger condition. The trigger signal is generated when the analog input signal is higher than the High-Threshold voltage. In this trigger condition, the Low-Threshold voltage is not used.



**Figure 3-10** Above high trigger condition

**Below low**

In below low trigger condition, the trigger signal is generated when the analog input signal is lower than the Low-Threshold voltage. In this trigger condition, the High-Threshold voltage is not used. The following figure illustrates the below low analog trigger condition.

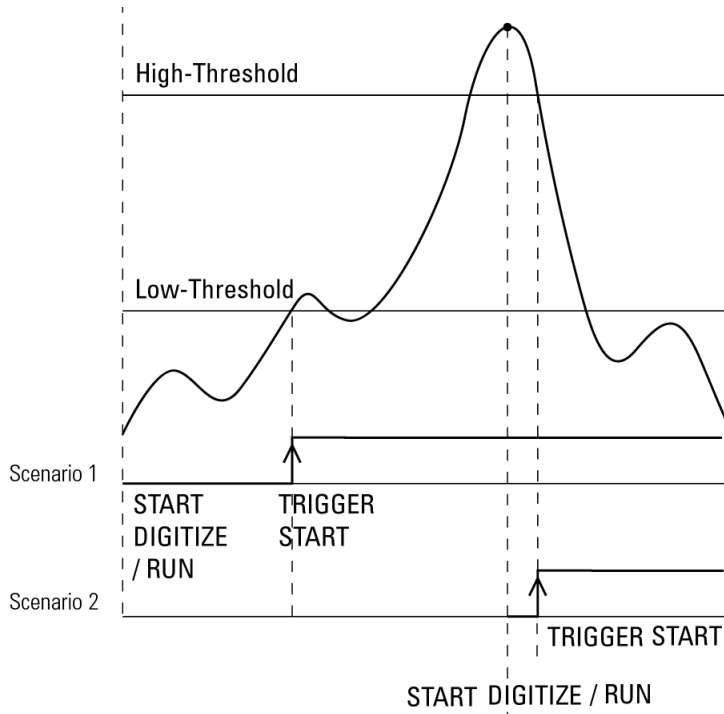


**Figure 3-11** Below low trigger condition



### Window

The window trigger condition is shown in the following diagram. The trigger signal is generated when the input analog signal falls within the voltage range of the High-Threshold and Low-Threshold.



**Figure 3-12** Window trigger condition

**NOTE**

The High-Threshold voltage must be set higher than Low-Threshold.

## SCPI Programming Examples

### Analog input

#### Example 1:

```

// Digital trigger with delay trigger type
// Supply Digital trigger signal to EXTD_AI_TRIG
-> *CLS; *RST
-> ROUT:ENAB 1, (@101)
-> ACQ:POIN 1000 // For "DIG" mode
-> ACQ:SRAT 1000
-> TRIG:SOUR EXTD // Digital Trigger
-> TRIG:DTRG:POL POS
-> TRIG:TYPE DEL
-> TRIG:DCNT 225000000 // Count value ~= 4.6875 s
-> WAV:STAT?
<- EMPT
-> WAV:COMP?
<- YES
-> DIG // Start single-shot acquisition
-> WAV:STAT?
<- FRAG
-> WAV:COMP? // To check acquisition completion for
DIG
<- NO
// Wait for trigger. Five seconds delay after the trigger event
-> WAV:STAT?
<- DATA
-> WAV:COMP?
<- YES
<- WAV:DATA?
<- #800002000 <byte><byte>... // Raw data returned by DAQ

```

**Example 2:**

```

// Digital trigger with Middle trigger type
-> *CLS; *RST
-> ROUT:ENAB 1, (@101)
-> WAV:POIN 1000 // For "RUN" mode
-> ACQ:SRAT 1000
-> TRIG:SOUR EXTD // Digital Trigger
-> TRIG:DTRG:POL POS
-> TRIG:TYPE MID
-> RUN

```

**Example 3:**

```

// Analog trigger with Pre trigger type
-> *CLS; *RST
-> ROUT:ENAB 1, (@101)
-> ACQ:POIN 1000 // For "DIG" mode
-> ACQ:SRAT 1000
-> ROUT:SCAN (@101)
-> ROUT:CHAN:POL BIP, (@101)
-> TRIG:SOUR EXTA // Analog trigger
-> TRIG:ATRG:COND AHIG // Above high Threshold trigger
                        condition
-> TRIG:ATRG:HTHR 3 // 3 V high Threshold
-> TRIG:ATRG:LTHR -3 // -3 V low Threshold
-> TRIG:TYPE PRE // Pre trigger
-> DIG
// Trigger will happen when signal go above 3 V

```

**Example 4:**

```
// Analog Trigger as trigger channel (CH101)  
-> *CLS; *RST  
-> ROUT:ENAB 1, (@101)  
-> ACQ:POIN 1000 // For "DIG" mode  
-> ACQ:SRAT 1000  
-> ROUT:CHAN:POL UNIP, (@133,101)  
-> TRIG:SOUR EXTA  
-> TRIG:ATRG:SOUR CH101 // Set trigger source to CH101  
-> TRIG:ATRG:COND BLOW // Below Low Threshold trigger  
condition  
-> TRIG:ATRG:HTHR 6 // 6 V High Threshold  
-> TRIG:ATRG:LTHR // 2 V Low Threshold  
-> TRIG:TYPE POST // Post Trigger  
-> DIG  
// Trigger will take place when signal fall below 2 V at channel 133
```

**NOTE**

Middle-trigger and pre-trigger are not allow in RUN mode, NONE trigger.

---

## Analog output

**Example 1:**

```

// Digital trigger with delay trigger type
// Supply Digital trigger signal to EXTD_AO_TRIG
-> OUTP:TRIG:SOUR EXTD
-> OUTP:TRIG:DTRG:POL NEG
-> OUTP:TRIG:TYPE DEL
-> OUTP:TRIG:DCNT 225000000 // Count value ~= 4.6875 s
-> ROUT:ENAB ON, (@201)
-> OUTP ON
// Wait for trigger
// Output turn on after 4.6875 s of delay (after trigger happen)

```

**Example 2:**

```

// Analog trigger with POST trigger type
-> OUTP:TRIG:SOUR EXTA
-> OUTP:TRIG:ATRG:COND WIND // Window trigger condition (-3 V
to 3 V)
-> OUTP:TRIG:ATRG:HTHR 3 // 3 V high Threshold
-> OUTP:TRIG:ATRG:LTHR -3 // -3 V low Threshold
-> OUTP:TRIG:TYPE POST
-> ROUT:ENAB ON, (@201)
-> OUTP ON

```

THIS PAGE HAS BEEN INTENTIONALLY LEFT BLANK.

# 4 Characteristics and Specifications

For the characteristics and specifications of the U2500A Series USB Simultaneous Sampling Multifunction Data Acquisition Devices, refer to the datasheet at <http://literature.cdn.keysight.com/litweb/pdf/5991-0651EN.pdf>.

THIS PAGE HAS BEEN INTENTIONALLY LEFT BLANK.



# 5 Calibration

Self-Calibration 82

This chapter introduces the procedures to perform calibration process to the U2500A series DAQ devices to minimize A/D measurement errors and D/A output errors.

## Self-Calibration

The Keysight U2500A series DAQ devices are factory-calibrated before shipment. The on-board reference voltage is calibrated and measured to ensure measurement accuracy. The device includes a self-calibration function to ensure accuracy of the measurement made under different environment usage.

For self-calibration, executing the calibration command will initiate a voltage adjustment in sequence for the specified DAC channel. This sequence sets a zero and gain adjustment constant for each DAC output.

Self-calibration can be initiated using the following SCPI command:

**CALibration:BEgin**

The functions of the DAQ will be halted until the self-calibration process is completed. You can query the status of calibration through the following SCPI command:

**\*OPC?**

The two ways of performing self-calibration will be introduced in this section. The first option is by using the Keysight Connection Expert to send the related SCPI commands and the second option is to use the Keysight Measurement Manager application software.

### Option 1: Self-calibration with Keysight Connection Expert

#### WARNING

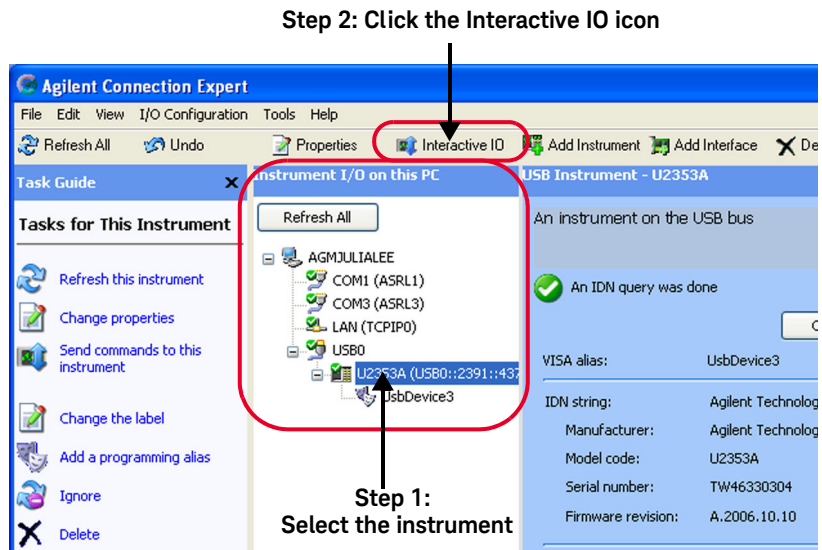
- Unplug all cables that are connected to the DAQ device before performing self-calibration.
  - Any cables connected to the DAQ device will cause the failure of the self-calibration process.
- 

#### NOTE

It is recommended that the DAQ device is powered-up at least 20 minutes before performing self-calibration.

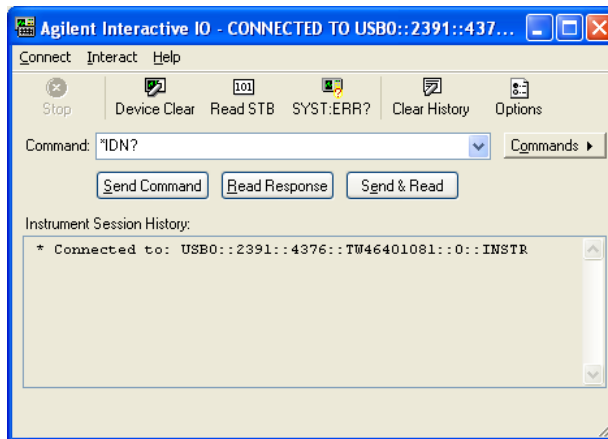
---

- 1 Power on the DAQ and disconnect all connections from the device. Warm it up for 20 minutes to ensure that it is operating in a stable condition.
- 2 Go to **Start > All Programs > Keysight IO Libraries Suite > Keysight Connection Expert** to launch the Keysight Connection Suite Expert.
- 3 Connect the DAQ device to the PC with a mini-B type USB cable. The connected DAQ device will be visible in the **Instrument I/O on this PC** panel as illustrated in [Figure 5-1](#).
- 4 Select the DAQ device that you wish to send the SCPI commands to and click the **Interactive IO** icon on the toolbar to launch the Keysight Interactive IO. See [Figure 5-1](#).



**Figure 5-1** Launch the Interactive IO in Keysight Connection Expert

- 5 The **Keysight Interactive IO** dialog box will appear as shown in [Figure 5-2](#). Click **Send & Read** to send the “\*IDN?” default command. This instrument’s response should appear in the **Instrument Session History** panel.
- 6 Successful communication between the Keysight Connection Expert and the connected hardware will be shown in the **Instrument Session History** panel. The users may now send other SCPI commands to the instrument.



**Figure 5-2** Interactive IO dialog box

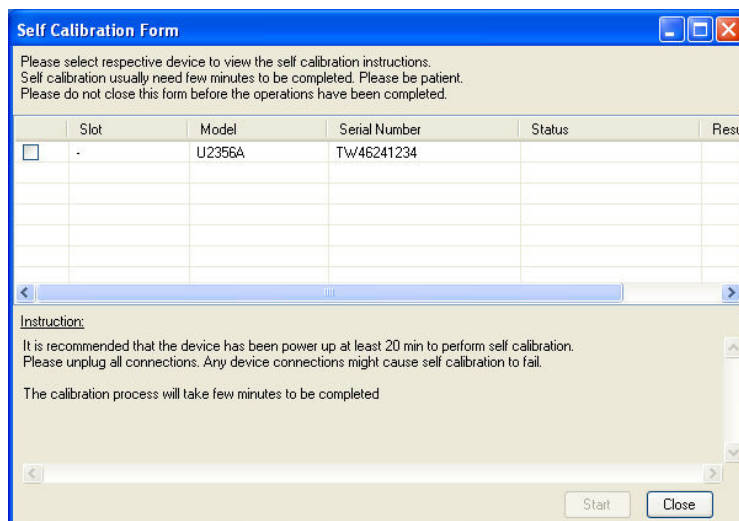
- 7 Ensure that the DAQ device has been warmed up for 30 minutes. Send the SCPI commands “\*RST” and “\*CLS” to clear the register in DAQ device.
- 8 Send “CAL :BEG” to start the self-calibration process. This process may take a few minutes to complete.
- 9 Send “\*OPC?” to check the operation complete status.
- 10 If “\*OPC?” returns 1, send “SYST:ERR?” to check if any system error has occurred during the self-calibration process. If there is no system error, the self-calibration process is done. Otherwise, the self-calibration process has failed.

### Option 2: Self-calibration with Keysight Measurement Manager

#### WARNING

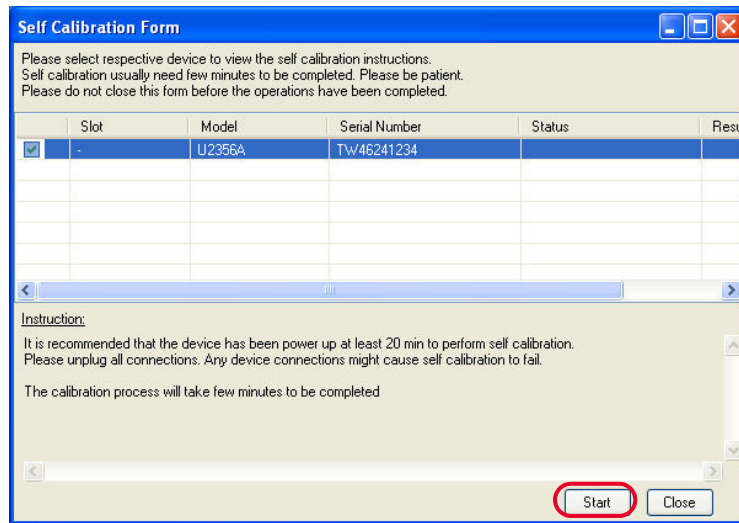
- Unplug all cables that are connected to the DAQ device before performing self-calibration.
- Any cables connected to the DAQ device may cause the failure of the self-calibration process.

- 1 Power on the DAQ device and disconnect all connections from it. Warm it up for 20 minutes to ensure that it is operating in a stable condition.
- 2 Connect the DAQ device to the PC with a mini-B type USB cable. Launch the Keysight Measurement Manager and select the DAQ device you wish to perform the self-calibration process on.
- 3 Go to **Tools** and select **Self Calibration**.
- 4 The **Self Calibration Form** dialog box will appear as shown below.

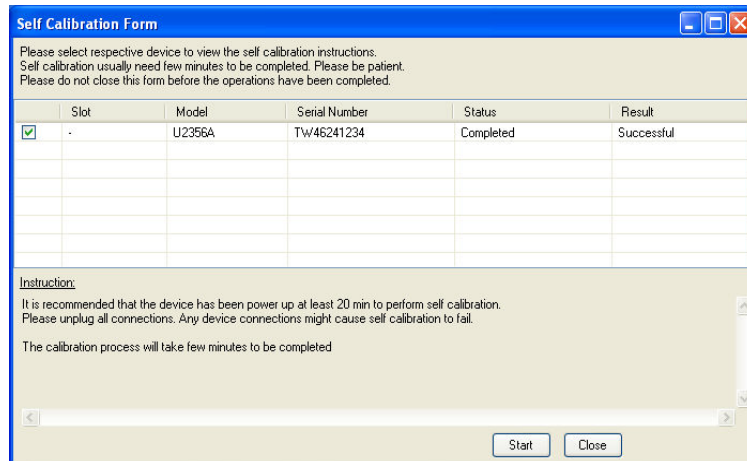


**Figure 5-3** Self Calibration Form dialog box in Keysight Measurement Manager

- 5 Select the instrument that you would like to perform self-calibration and the **Start** button will be enabled. Click the **Start** button to proceed. See [Figure 5-4](#).
- 6 The calibration process will take a few minutes to be completed. Once done, the status and results of the process will be displayed as shown in [Figure 5-5](#).



**Figure 5-4** Self Calibration Form dialog box in Keysight Measurement Manager with a device being selected



**Figure 5-5** Self Calibration Form dialog box in Keysight Measurement Manager showing the status and result of the self-calibration process



This information is subject to change without notice. Always refer to the Keysight website for the latest revision.

© Keysight Technologies 2007-2017  
Edition 9, June 1, 2017

Printed in Malaysia



U2541-90011

[www.keysight.com](http://www.keysight.com)