

Keysight U2300A Series USB Multifunction Data Acquisition Devices

Programmer's
Reference

Notices

Copyright Notice

© Keysight Technologies 2006-2017
No part of this manual may be reproduced in any form or by any means (including electronic storage and retrieval or translation into a foreign language) without prior agreement and written consent from Keysight Technologies as governed by United States and international copyright laws.

Manual Part Number

U2351-90202

Edition

Edition 8, June 1, 2017

Printed in:

Printed in Malaysia

Published by:

Keysight Technologies
Bayan Lepas Free Industrial Zone,
11900 Penang, Malaysia

Technology Licenses

The hardware and/or software described in this document are furnished under a license and may be used or copied only in accordance with the terms of such license.

Declaration of Conformity

Declarations of Conformity for this product and for other Keysight products may be downloaded from the Web. Go to <http://www.keysight.com/go/conformity>. You can then search by product number to find the latest Declaration of Conformity.

U.S. Government Rights

The Software is “commercial computer software,” as defined by Federal Acquisition Regulation (“FAR”) 2.101. Pursuant to FAR 12.212 and 27.405-3 and Department of Defense FAR Supplement (“DFARS”) 227.7202, the U.S. government acquires commercial computer software under the same terms by which the software is customarily provided to the public. Accordingly, Keysight provides the Software to U.S. government customers under its standard commercial license, which is embodied in its End User License Agreement (EULA), a copy of which can be found at <http://www.keysight.com/find/sweula>. The license set forth in the EULA represents the exclusive authority by which the U.S. government may use, modify, distribute, or disclose the Software. The EULA and the license set forth therein, does not require or permit, among other things, that Keysight: (1) Furnish technical information related to commercial computer software or commercial computer software documentation that is not customarily provided to the public; or (2) Relinquish to, or otherwise provide, the government rights in excess of these rights customarily provided to the public to use, modify, reproduce, release, perform, display, or disclose commercial computer software or commercial computer software documentation. No additional government requirements beyond those set forth in the EULA shall apply, except to the extent that those terms, rights, or licenses are explicitly required from all providers of commercial computer software pursuant to the FAR and the DFARS and are set forth specifically in writing elsewhere in the EULA. Keysight shall be under no obligation to update, revise or otherwise modify the Software. With respect to any technical data as defined by FAR 2.101, pursuant to FAR 12.211 and 27.404.2 and DFARS 227.7102, the U.S. government acquires no greater than Limited Rights as defined in FAR 27.401 or DFAR 227.7103-5 (c), as applicable in any technical data.

Warranty

THE MATERIAL CONTAINED IN THIS DOCUMENT IS PROVIDED “AS IS,” AND IS SUBJECT TO BEING CHANGED, WITHOUT NOTICE, IN FUTURE EDITIONS. FURTHER, TO THE MAXIMUM EXTENT PERMITTED BY APPLICABLE LAW, KEYSIGHT DISCLAIMS ALL WARRANTIES, EITHER EXPRESS OR IMPLIED, WITH REGARD TO THIS MANUAL AND ANY INFORMATION CONTAINED HEREIN, INCLUDING BUT NOT LIMITED TO THE IMPLIED WARRANTIES OF MERCHANTABILITY AND FITNESS FOR A PARTICULAR PURPOSE. KEYSIGHT SHALL NOT BE LIABLE FOR ERRORS OR FOR INCIDENTAL OR CONSEQUENTIAL DAMAGES IN CONNECTION WITH THE FURNISHING, USE, OR PERFORMANCE OF THIS DOCUMENT OR OF ANY INFORMATION CONTAINED HEREIN. SHOULD KEYSIGHT AND THE USER HAVE A SEPARATE WRITTEN AGREEMENT WITH WARRANTY TERMS COVERING THE MATERIAL IN THIS DOCUMENT THAT CONFLICT WITH THESE TERMS, THE WARRANTY TERMS IN THE SEPARATE AGREEMENT SHALL CONTROL.

Safety Information

CAUTION

A CAUTION notice denotes a hazard. It calls attention to an operating procedure, practice, or the like that, if not correctly performed or adhered to, could result in damage to the product or loss of important data. Do not proceed beyond a CAUTION notice until the indicated conditions are fully understood and met.

WARNING

A WARNING notice denotes a hazard. It calls attention to an operating procedure, practice, or the like that, if not correctly performed or adhered to, could result in personal injury or death. Do not proceed beyond a WARNING notice until the indicated conditions are fully understood and met.

Table of Contents

1	Introduction to SCPI	
	Introduction to the SCPI Language	14
	SCPI Conventions and Data Formats	15
	Command separators	16
	Syntax conventions	19
	Syntax diagram conventions	20
	Data types and formats	21
	Input message terminators	24
	Using device clear	24
	SCPI Status System	25
	Standard Event register	27
	Status Byte register	28
2	ACQUIRE Subsystem	
	ACQUIRE:SRATE	30
	ACQUIRE:POINTS	33
	ACQUIRE:BURST	36
3	APPLY Subsystem	
	APPLY?	40
	APPLY:SINusoid	41
	APPLY:SQUare	43
	APPLY:SAWTooth	45
	APPLY:TRIangle	47
	APPLY:NOISe	49
	APPLY:USER	51
4	CALIBRATION Subsystem	
	CALIBRATION:BEGIN	54

5	CONFigure Subsystem	
	CONFigure:DiGital:DiRection	56
	CONFigure:TiMEbase:SOURce	58
	CONFigure:TiMEbase:ECLoCK	60
	CONFigure:SSi	62
6	MEASure Subsystem	
	MEASure[:VOLTage][:DC]?	66
	MEASure:COUNter:DATA?	68
	MEASure:COUNter:FREQuency?	70
	MEASure:COUNter:PERiod?	72
	MEASure:COUNter:PWIDth?	74
	MEASure:COUNter:TOTalize?	76
	MEASure:DiGital?	78
	MEASure:DiGital:BIT?	80
7	OUTPut Subsystem	
	OUTPut	84
	OUTPut:WAVeform:ITERate	86
	OUTPut:WAVeform:SRATe	88
	OUTPut:WAVeform:FREQuency	91
	OUTPut:TRIGger:SOURce	93
	OUTPut:TRIGger:TYPe	95
	OUTPut:TRIGger:DCouNT	97
	OUTPut:TRIGger:ATRiGger:SOURce	99
	OUTPut:TRIGger:ATRiGger:CONDition	102
	OUTPut:TRIGger:ATRiGger:HTHReshold	105
	OUTPut:TRIGger:ATRiGger:LTHReshold	107
	OUTPut:TRIGger:DTRiGger:POLarity	109

8 ROUTe Subsystem

ROUTe:SCAN	112
ROUTe:CHANnel:RANGe	114
ROUTe:CHANnel:POLarity	116
ROUTe:CHANnel:STYPe	118
ROUTe:CHANnel:RSouRCe	120
ROUTe:CHANnel:RVOLTage	122
ROUTe:ENABLE	124

9 SENSE Subsystem

[SENSe:]VOLTage:RANGe	128
[SENSe:]VOLTage:POLarity	131
[SENSe:]VOLTage:STYPe	133
[SENSe:]COUNter:FUNCTion	136
[SENSe:]COUNter:ABORt	138
[SENSe:]COUNter:GATE:SOURce	140
[SENSe:]COUNter:GATE:POLarity	142
[SENSe:]COUNter:GATE:CONTRol	144
[SENSe:]COUNter:CLock:SOURce	146
[SENSe:]COUNter:CLock:INTernal?	148
[SENSe:]COUNter:CLock:EXTernal	149
[SENSe:]COUNter:CLock:POLarity	151
[SENSe:]COUNter:TOTALize:IVALue	153
[SENSe:]COUNter:TOTALize:INITiate	155
[SENSe:]COUNter:TOTALize:CLEar	156
[SENSe:]COUNter:TOTALize:UDOWn:SOURce	158
[SENSe:]COUNter:TOTALize:UDOWn:DIRection	160

10	SOURce Subsystem	
	SOURce:VOLTage[:LEVel]	164
	SOURce:VOLTage:POLarity	166
	SOURce:VOLTage:RSouRce	168
	SOURce:VOLTage:RVOLTage	170
	SOURce:DIGital:DATA	172
	SOURce:DIGital:DATA:BIT	174
11	SYSTEM Subsystem	
	SYSTEM:CDEscription?	178
	SYSTEM:ERRor?	179
12	TRIGger Subsystem	
	TRIGger:SOURce	182
	TRIGger:TYPe	184
	TRIGger:DCouNT	187
	TRIGger:ATRiGger:SOURce	189
	TRIGger:ATRiGger:CONDition	192
	TRIGger:ATRiGger:HTHReshold	195
	TRIGger:ATRiGger:LTHReshold	197
	TRIGger:DTRiGger:POLarity	199
13	WAVEform Subsystem	
	WAVEform:DATA?	202
	WAVEform:POINts	204
	WAVEform:STATus?	207
	WAVEform:COMPLete?	209
14	Root Commands	
	DIGitize	212
	RUN	214
	STOP	216

MODel?	217
SERial?	218
DATA[:USER]	219
Using the IEEE-488.2 binary block format	221
15 IEEE-488.2 Common Commands	
*CLS	224
*ESE	225
*ESR?	227
*IDN?	228
*OPC	229
*RCL	230
*RST	232
*SAV	233
*SRE	234
*STB?	236
*TST?	237
*WAI	238
16 Error Messages	
Error Messages	240
SCPI command errors	241
SCPI execution errors	244
SCPI device-specific errors	245
SCPI query errors	246
SCPI instrument errors	247
17 Factory Default Settings	
Factory Default Settings	250
Command Quick Reference	255

THIS PAGE HAS BEEN INTENTIONALLY LEFT BLANK.

List of Figures

Figure 1-1	A typical syntax diagram	20
Figure 1-2	Status system diagram	26

THIS PAGE HAS BEEN INTENTIONALLY LEFT BLANK.

List of Tables

Table 15-1	Standard Event register mapping	225
Table 15-2	Status Byte register mapping	234
Table 16-1	List of SCPI command errors	241
Table 16-2	List of SCPI execution errors	244
Table 16-3	List of SCPI device-specific errors	245
Table 16-4	List of SCPI query errors	246
Table 16-5	List of SCPI instrument errors	247
Table 17-1	List of the factory default settings	251

THIS PAGE HAS BEEN INTENTIONALLY LEFT BLANK.

1 Introduction to SCPI

Introduction to the SCPI Language	14
SCPI Conventions and Data Formats	15
SCPI Status System	25

This chapter introduces the remote programming basics of the U2300A Series DAQ device. The SCPI programming commands provide the means to control this instrument remotely via a PC.

Introduction to the SCPI Language

SCPI, also known as the Standard Commands for Programmable Instruments, is an ASCII-based instrument command language designed for test and measurement instruments. SCPI commands defines how you communicate with an instrument from a bus controller.

They are based on a hierarchical structure, similar to the file systems used by many bus controllers. This hierarchical structure is also known as a tree system. In this system, associated commands are grouped together under a common node or root, thus forming subsystems. You must specify the complete path to execute the individual lower-level commands. A portion of the **SOURce** subsystem is shown below to illustrate the tree system.

SOURce

:VOLTage

[:LEVel] <value>, <ch_list>

[:LEVel]? <ch_list>

SOURce

:DIGital

:DATA <value>, <ch_list>

:DATA? <ch_list>

SOURce is the root keyword of the command, **VOLTage** and **DIGital** are second-level keywords, and **LEVel** and **DATA** are third-level keywords. A colon (:) separates a command keyword from a lower-level keyword.

Mnemonic forms

Each keyword has both a long and a short form. A standard notation is used to differentiate the short form keyword from the long form keyword. The long form of the keyword is shown, with the short form portion shown in uppercase characters, and the rest of the keyword shown in lowercase characters. For example, the short form of **SOURce** is **SOUR**.

For shorter program lines, you can send the abbreviated form. For better program readability, you can send the long form. For example, in the above syntax statement, **SOURce** and **SOUR** are both acceptable forms. You can use a mixture of upper-case and lower-case letters. Therefore, **SOURCE**, **sour**, and **Sour** are all acceptable forms. Other forms, such as **SOU** and **sourc**, are not valid and will generate an error.

SCPI Conventions and Data Formats

Throughout this document, the following conventions and formats are used in the SCPI command examples. The examples are presented in the following manner:

Example

This programming snippet illustrates how several commands are used together to instruct the DAQ device to acquire 100 points of data through a single-shot acquisition process.

→ ROUT:SCAN (@101)

A right directional arrow (→) indicates a command that is sent to the instrument.

The abbreviated form of the command is favoured over the long form for shorter program lines. See “*Mnemonic forms*” on page 14 for more information.

Optional keywords are omitted in the command syntax. See “*Square brackets*” on page 19 for more information.

→ ACQ:SRAT 2000

Some commands may be omitted if the operation is not required.^[1]

→ ACQ:POIN 100

The particular command or query in question is highlighted in the programming snippet.

This example illustrates how the “ACQ:POIN” command is used within a larger programming module.

→ DIG

→ WAV:DATA?

A command ending with a “?” indicates a query that is sent to the instrument. See “*Using “?” commands*” on page 18 for more information.

← #800000200<byte1>
<byte2>...<byte200>

A left directional arrow (←) indicates a return message from the instrument.

[1] In this instance, omitting the “ACQ:SRAT 2000” command will result in the AI sampling rate unchanged at 1000 Hz (the instrument default sampling rate).

Command separators

Using a colon

A colon (:) is used to separate a command keyword from a lower-level keyword. When a colon is inserted between two command mnemonics, the colon moves the path down one level in the present path (for the specified root-level command) of the command tree. You must separate command mnemonics from each other using a colon as shown below:

→ **SENS:COUN:GATE:POL AHI, (@301)**

An error is generated if you do not use the colon in your command string.

→ **SENS COUN GATE POL AHI, (@301)**

→ **SYST:ERR?**

Typical response:

← **-133, "Undefined header"**

When a colon is the first character of a command keyword, it indicates that the next command mnemonic is a root-level command.

→ **:ROUT:ENAB 1, (@201)**

This indicates that the **ROUT** command mnemonic is a root-level command. However, you can omit the leading colon if the command is the first of a new program line.

→ **ROUT:ENAB 1, (@201)**

Using a semicolon

Use a semicolon (;) to separate two commands within the same command string. For example, sending the following command string:

→ **:VOLT:RANG 5, (@101); :VOLT:POL BIP, (@101)**

is the same as sending the following two commands:

→ **VOLT:RANG 5, (@101)**

→ **VOLT:POL BIP, (@101)**

Note that in the first statement, the first colon is optional but the third is compulsory.

Using a comma

If a command requires more than one parameter, you must separate adjacent parameters using a comma (,).

APPLY:SINusoid <amplitude>, <offset>, <ch_list>

The triangle brackets are not sent with the command string. See “[Syntax conventions](#)” on page 19 for more information.

→ **APPL:SIN 5, 1, (@201)**

Using whitespace

You must use whitespace characters, [tab], or [space] to separate a parameter from a command keyword. Whitespace characters are generally ignored only in parameter lists. You may omit the whitespace characters only in parameter lists.

For example, sending the following command:

→ **APPL:SIN 5,1,(@201)**

is the same as sending this command:

→ **APPL:SIN 5, 1, (@201)**

However, an error is generated if you do not use a whitespace character to separate a parameter from a command keyword in your command string.

→ **APPL:SIN5,1,(@201)**

→ **SYST:ERR?**

Typical response:

← **-133,"Undefined header"**

Using “?” commands

The bus controller may send commands at any time, but a SCPI-equipped instrument may only send responses when specifically instructed to do so.

Only query commands (commands that end with a “?”) will instruct the instrument to send a response message. Queries return either measured values or internal instrument settings.

For example, the following command sets the output waveform frequency to 5 kHz:

→ `OUTP:WAV:FREQ 5000`

You can then query the frequency setting in the instrument by sending:

→ `OUTP:WAV:FREQ?`

Typical response:

← `5000`

NOTE

If you send two query commands without reading the response from the first, then attempt to read the second response, you may receive some data from the first response followed by the complete second response. To avoid this, do not send a query command without reading the response. When you cannot avoid this situation, send a device clear before sending the second query command. See [“Using device clear”](#) on page 24 for more information.

Using “*” commands

Commands starting with a “*” are called common commands. They are required to perform the identical function for all instruments that are compliant with the IEEE-488.2 interface standard. Common commands always begin with an asterisk (*), are three characters in length, and may include one or more parameters. The “*” commands are used to control reset, self-test, and status operations in the DAQ device.

→ `*RST; *CLS`

See [Chapter 15, “IEEE-488.2 Common Commands”](#) on page 223 for a complete list of all common commands supported.

Syntax conventions

The following SCPI conventions are used throughout this document.

Braces

Braces “{ }” enclose the parameter choices for a given command string. For example, the syntax statement below shows that you have to choose a mode (either **NONE**, **MAST** or **SLAV**) for the SSI configuration.

CONF:SSI {NONE|MAST|SLAV}

The braces are not sent with the command string. A vertical bar “|” separates multiple parameter choices for a given command string.

→ **CONF:SSI MAST**

Triangle brackets

Triangle brackets “< >” indicate that you must specify a value for the enclosed parameter. For example, the syntax statement below shows the **<value>** parameter enclosed in triangle brackets:

OUTPut:WAVeform:FREQuency <value>

The brackets are not sent with the command string. You must specify a value for the parameter:

→ **OUTP:WAV:FREQ 5000**

Square brackets

Some commands and parameters are enclosed in square brackets “[]”. This indicates that the command or parameter is optional and can be omitted. For example, the syntax statement below shows that the **SENSe** root keyword is optional and can be omitted.

[SENSe:]VOLTage:RANGe <range>, <ch_list>

The brackets are not sent with the command string.

→ **VOLT:RANG 5, (@101)**

For parameters enclosed in square brackets, if you do not specify a value for the optional parameter, the instrument chooses a default value.

Syntax diagram conventions

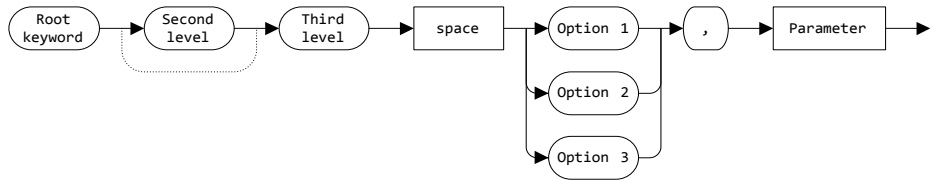





Figure 1-1 A typical syntax diagram

- Solid lines represent the recommended path.
-  Ovals enclose the abbreviated command mnemonics. The command mnemonic must be entered exactly as shown. Ovals are also used to represent discrete parameters and command separators.
-  Rectangles enclose the parameters required. See **“Data types and formats”** on page 21 for a complete list of the various data types and formats used throughout this document. Rectangles are also used to represent whitespace characters.
-  Dotted lines indicate an optional path for bypassing (omitting) command keywords.
-  Arrows and curved intersections indicate the command path direction.

Data types and formats

The SCPI language defines different data formats for use in program messages and response messages. Instruments are flexible listeners and can accept commands and parameters in various formats. However, SCPI-equipped instruments are precise talkers. This means that SCPI-equipped instruments always respond to a particular query in a predefined, rigid format.

Numeric

Parameters that accepts all commonly used decimal representations of numbers including optional signs, and decimal points, scientific notations ($3e2 = 3 \times 10^2$, $5.43e-3 = 5.43 \times 10^{-3}$, or $10e6 = 10 \times 10^6$), and engineering notations (M, k, m, μ , n). Special values for numeric parameters such as **AUTO**, **MIN**, **MAX**, and **DEF** are also accepted. If only specific numeric values are accepted, the instrument will automatically round the input numeric parameters. As an example, the following command requires a numeric parameter for the range value:

```
[SENSe:]VOLTage:RANGe <range>, <ch_list>
```

NOTE

While most SCPI command sets supports the use of scientific and engineering notations, the U2300A Series DAQ device does not support the use of scientific and engineering notation. Magnitude prefixes like *mega-* (e = 6), *kilo-* (e = 3), *milli-* (e = -3), *micro-* (e = -6), or *nano-* (e = -9) are mentioned in the parameter range of values whenever applicable.

Discrete

Parameters used to program settings that have a limited number of values such as **INTernal**, **EXternal**, and **CCG**. Some of these parameters have a short form and a long form just like command keywords. You can mix upper-case and lower-case letters. Query responses will always return the abbreviated form in all upper-case letters. As an example, the following command require discrete parameters for the digital channel direction:

```
CONFigure:DIgital:DIRection {INPut|OUTput}, <ch_list>
```

Boolean

Parameters that represent a single binary condition that is either true or false. For a false condition, the DAQ device will accept **OFF** or **0**. For a true condition, the DAQ device will accept **ON** or **1**. When you query a boolean setting, the DAQ device will always return **0** or **1**. As an example, the following command require boolean parameters for the instrument output status:

```
OUTPut {0|OFF|1|ON}
```

String

Parameters that contain virtually any set of ASCII characters. A string must begin and end with matching quotes; either with a single quote or a double quote. You can include the quote delimiter as part of the string by typing it twice without any characters in between.^[1]

Channel list

Channel list parameters have the form (**@ccc**), where **ccc** is the channel number. You can specify a single channel, multiple channels, or a range of channels. The channel list must be preceded with the “@” symbol and must be enclosed in parentheses “()”. As an example, the following commands use a channel list parameter:

```
ROUTe:SCAN <ch_list>; MEASure:COUNTER:DATA? <ch_list>
```

The following command includes channel 101 in the instrument scan list.

```
→ ROUT:SCAN (@101)
```

Consecutive channels can be specified using a colon or comma. The following command includes channel 101, 102, and 105 in the instrument scan list.

```
→ ROUT:SCAN (@101,102,105)
```

The following command includes channel 105 through 110 and 115.

```
→ ROUT:SCAN (@105:110,115)
```

When you specify a range of channels, any channel that is invalid will generate an error.

[1] The U2300A Series DAQ device currently does not support any command with string parameters.

When more than one channel is specified in the command parameter, the U2300A Series DAQ device will acquire the measurement points alternately from each specified channel when a readback query is sent (**WAV:DATA?** or **MEAS?**).

Example 1

```
→ ROUT:SCAN (@101,102)
→ ACQ:SRAT 1000;:ACQ:POIN 3;:DIG
→ WAV:DATA?
→ #800000012<byte1_ch101><byte1_ch102><byte2_ch101>
  <byte2_ch102>...<byte6_ch101><byte6_ch102>
```

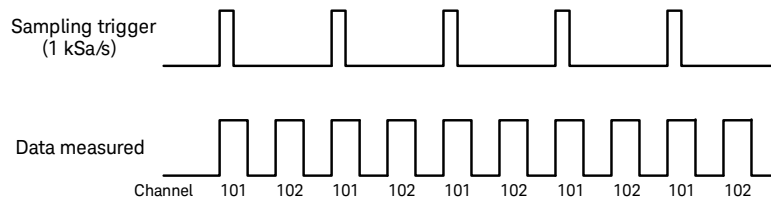

Example 2

```
→ ROUT:SCAN (@101,102,105)
→ ACQ:SRAT 1000;:WAV:POIN 1000;:RUN
→ WAV:DATA?
← #800006000<byte1_ch101><byte1_ch102><byte1_ch105><byte2_ch101>
  <byte2_ch102><byte2_ch105><byte3_ch101><byte3_ch102><byte3_ch
  105>...<byte2000_ch101><byte2000_ch102><byte2000_ch105>
```

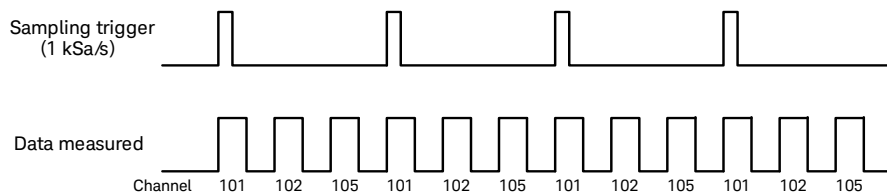

Input message terminators

Program messages sent to a SCPI-equipped instrument must terminate with a `<newline>` character. The IEEE.488 EOI (end or identify) signal is interpreted as a `<newline>` character and may also be used to terminate a message in place of the `<newline>` character. A `<carriage return>` followed by a `<newline>` is also accepted. Many programming languages allow you to specify a message terminator character or EOI state to be automatically sent with each bus transaction. Message termination always sets the current path back to the root-level.

Using device clear

Device clear is an IEEE-488 low-level bus message that you can use to return the instrument to a responsive state (for example, during a lengthy query).

Different programming languages and IEEE-488 interface cards provide access to this capability through their own unique commands. The status registers, the error queue, and all configuration states are left unchanged when a device clear message is received.

Device clear performs the following actions:

- 1 If a scan is running, it is aborted.
- 2 The instrument returns to the trigger “idle” state.
- 3 The instrument's input and output buffers are cleared.
- 4 The instrument is prepared to accept a new command string.

An overlapped command, if any, will be terminated with no “Operation Complete” indication.

NOTE

It is recommended that you allow for a two-second wait following a device clear to enable the instrument to process the clear operation.

SCPI Status System

The status system records various instrument conditions and states in several register groups. Each register group is made up of several low-level registers called the Condition register, Event register, and Enable register which control the action of specific bits within the register group.

A Condition register continuously monitors the state of the instrument. The bits in the condition register are updated in real-time and the bits are not latched or buffered. This is a read-only register and the bits are not cleared when you read the register.

An Event register latches the various events from the changes in the Condition register. There is no buffering in this register; while an event bit is set, subsequent events corresponding to that bit are ignored. This is a read-only register. Once a bit is set, it remains set until cleared by a query or clear status (*CLS) command.

An Enable register defines which bits in the event register will be reported to the Status Byte register group. You can write to or read from an Enable register.

The relationship between various registers in the U2300A Series DAQ device SCPI status system is shown in [Figure 1-2](#).

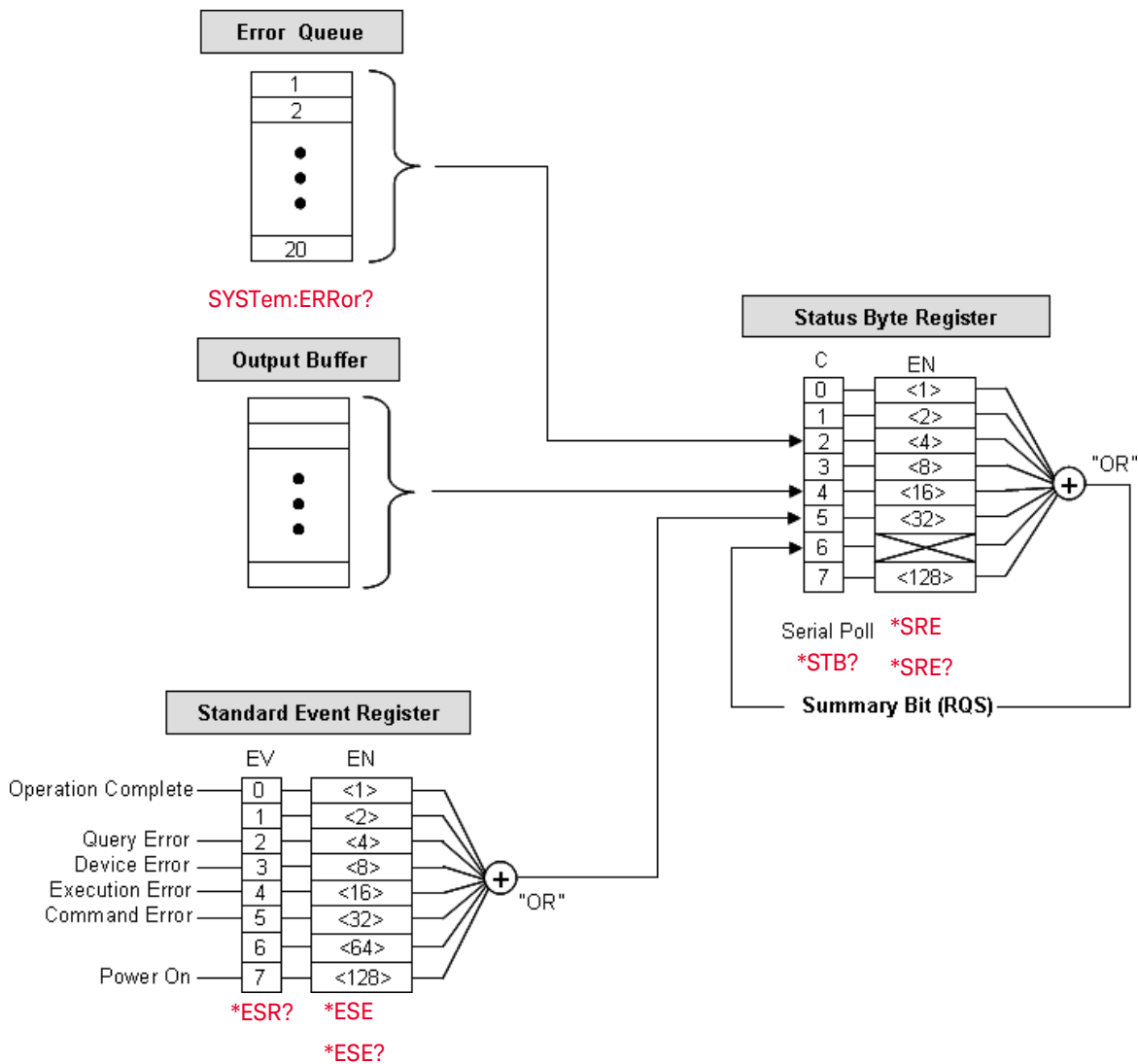

Figure 1-2 Status system diagram

Standard Event register

The Standard Event register group reports the following types of instrument events: power-on detected, command syntax errors, command execution errors, device errors (self-test or calibration), or query errors. All of these conditions can be reported in the Standard Event summary bit through the enable register. To set the enable register mask, key in a decimal value to the register using the event status enable (***ESE**) command.

Bit definitions: Standard Event register

Bit number	Decimal value	Definition
0 Operation complete	1	All command have been executed.
1 Not used	Not used	"0" is returned.
2 Query error	4	The instrument tried to read the output buffer but it was empty. Or, a new command line was received before a previous query has been read. Or, both the input and output buffers are full.
3 Device error	8	A self-test, calibration, or other device-specific error has occurred.
4 Execution error	16	An execution error occurred.
5 Command error	32	A command syntax error occurred.
6 Not used	Not used	"0" is returned.
7 Power-on	128	Power has been turned off and on since the last time the event register was read or cleared.

The event register in the Standard Event is cleared when:

- you execute the clear status (***CLS**) command, or
- you read the event register using the event status register (***ESR?**) command.

The Standard Event enable register is cleared when you execute the ***ESE 0** command.

NOTE

When a command, execution, device, or query error have occurred, a related error message will be generated. For a complete listing of all error messages, refer to **Chapter 16, "Error Messages"** on page 239.

Status Byte register

The Status Byte register group reports the conditions from the other status registers. Clearing an event register from one of the other registers will clear the corresponding bits in the Status Byte condition register. Data that is waiting in the U2300A Series DAQ device output buffer is immediately reported on the “Message Available” bit (bit 4).

Bit definitions: Status Byte register

Bit number	Decimal value	Definition
0 Not used	Not used	“0” is returned.
1 Not used	Not used	“0” is returned.
2 Error queue	4	One or more errors have been stored in the Error Queue. Use the SYSTem:ERRor? query to read and delete errors.
3 Not used	Not used	“0” is returned.
4 Message available	16	Data is available in the instrument output buffer for single SCPI queries (for example, *OPC? , MEAS? (@101) , *IDN? , SYST:ERR? , and so on) but not in the continuous acquisition output buffer.
5 Standard Event summary	32	One or more bits are set in the Standard Event register. Bits must be enabled using the *ESE command.
6 Master Status summary	64	One or more bits are set in the Status Byte Register and may generate a Request for Service (RQS). Bits must be enabled using the *SRE command.
7 Not used	Not used	“0” is returned.

The Status Byte condition register will be cleared when:

- you execute the clear status (***CLS**) command, or
- you read the event register from one of the other register groups. (Only the corresponding bits are cleared in the condition register.)

The Status Byte enable register is cleared when you execute the ***SRE 0** command.

NOTE

Refer to **Chapter 15, “IEEE-488.2 Common Commands”** on page 223 for more details on the common commands mentioned above.

2 ACQUIRE Subsystem

ACQUIRE:SRATE	30
ACQUIRE:POINTS	33
ACQUIRE:BURST	36

This chapter describes the ACQUIRE commands used to program the U2300A Series DAQ device over a remote interface. Use the ACQUIRE commands to set the sampling rate and burst mode for the DAQ device input channels. You can also set the number of acquisition points for the single-shot acquisition process.

ACQuire:SRATe

Syntax

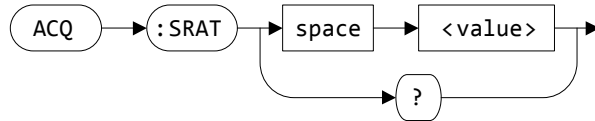
**ACQuire:SRATe <value>**

This command is used to set the sampling rate of the analog input (AI) channels.

ACQuire:SRATe?

This query returns a numeric value that represents the instrument sampling rate. The value returned is expressed in hertz (Hz).

Supported models

U2351A, U2352A, U2353A, U2354A, U2355A, U2356A, U2331A

Parameter

Item	Type	Range of values	Default value
value	Numeric	<ul style="list-style-type: none"> - U2351A/52A/55A: 3 Hz to 250000 Hz (250 kHz) - U2353A/54A/56A: 3 Hz to 500000 Hz (500 kHz) - U2331A: 3 Hz to 3000000 Hz (3 MHz) 	1000 Hz

Remarks

- The sampling rate (or sampling frequency) defines the number of samples per second taken from a continuous signal to make a discrete signal. For time-domain signals, it is measured in hertz (Hz). The inverse of the sampling frequency is the sampling period or sampling interval, which is the time between samples.
- Since the U2300A Series DAQ device has multiplexing analog inputs, the maximum sampling rate is dependant on the maximum ADC sampling rate and the number of entries in the scan list (as defined by the **ROUTE:SCAN** command), given as:

<sampling rate value> / <number of entries in scan list>

For example, if four channels are specified in the scan list of the U2356A, the maximum sampling rate is actually 500 kSa/s (500 kHz) divided by four, which is 125 kSa/s for each channel.

However, for the U2331A, the maximum sampling rate is only up to 1 MSa/s when switching of multiple channels is enabled.

NOTE

For more information on setting up a scan list see **“ROUTE:SCAN”** on page 112. To initiate an acquisition process, use either the **DIGitize** command (for single-shot acquisition) or **RUN** command (for continuous acquisition).

See also

“ROUTE:SCAN” on page 112

“DIGitize” on page 212

“RUN” on page 214

Example

This example illustrates how the **ACQuire:SRATe** command is used to set the AI sampling rate.

→ ROUT:SCAN (@101,102,103,104)	<i>This command sets the scan list to include channel 101, 102, 103, and 104. Since four entries were specified in the scan list, the maximum sampling rate (for the U2355A) is reduced to 62.5 kHz (250 kHz / 4) per channel.</i>
→ ACQ:SRAT 200000	<i>This command sets the AI sampling rate to 200 kHz. This implies that a measurement is taken every 0.005 ms (1 / 200 kHz).</i>
→ SYST:ERR?	<i>This command reads the error(s) stored in the DAQ device error queue.</i>
← -221,"Settings conflict; sampling rate beyond range because of number of channel"	<i>The returned value "-221" indicates that a conflicting setting is detected. This is because four entries were specified in the scan list; therefore the maximum sampling rate (for the U2355A) per channel is only 62.5 kHz instead of 250 kHz. The sampling rate is applicable to each enabled channel in the scan list.</i>
→ ACQ:SRAT 2000	<i>This command sets the AI sampling rate to 2 kHz. This implies that a measurement is taken every 0.5 ms (1 / 2 kHz). The value used here is well below the maximum sampling rate for each channel.</i>
→ SYST:ERR?	
← +0,"No error"	<i>The returned value "+0" indicates that there are no errors recorded.</i>

ACQuire:POINts

Syntax

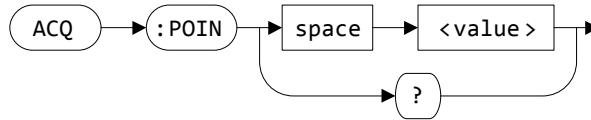

ACQuire:POINts <value>

This command is used to set the number of acquisition points for the single-shot acquisition process.

ACQuire:POINts?

This query returns a numeric value that represents the number of acquisition points set for the single-shot acquisition process.

NOTE

The single-shot acquisition is initiated by the DIGitize command. Use the STOP command to stop the single-shot acquisition process before the number of points specified is reached.

Supported models

U2351A, U2352A, U2353A, U2354A, U2355A, U2356A, U2331A

Parameter

Item	Type	Range of values	Default value
value	Numeric	Maximum of 8 Msa	500

Remarks

- This command performs the same functions as the **WAVEform:POINTS** command. The only difference is that the **WAVEform:POINTS** command is used for continuous acquisitions, while the **ACQUIRE:POINTS** command is used for single-shot acquisitions.
- Each acquisition point is made up of two bytes. Hence, setting the acquisition points to 100 implies that a block of 200 bytes of raw data is transferred to the PC when the **WAVEform:DATA?** query is issued.

See also

[“ACQUIRE:SRATE”](#) on page 30

[“ROUTE:SCAN”](#) on page 112

[“WAVEform:COMPLETE?”](#) on page 209

[“WAVEform:DATA?”](#) on page 202

[“WAVEform:POINTS”](#) on page 204

[“DIGITIZE”](#) on page 212

[“STOP”](#) on page 216

Example

This example illustrates how the **ACQuire:POINts** command is used to acquire 100 sample points (200 bytes) of raw data from AI channel 101.

→ ROUT:SCAN (@101)	<i>This command sets the instrument to monitor channel 101.</i>
→ ACQ:SRAT 1000	<i>This command sets the AI sampling rate to 1 kHz.</i>
→ ACQ:POIN 100	<i>This command sets the instrument to acquire 100 sample points.</i>
→ DIG	<i>This command starts the single-shot acquisition process.</i>
→ WAV:COMP?	<i>This query returns the acquisition status of the instrument.</i>
← YES	<i>The returned value is YES, indicating that the data acquisition is completed and ready to be read back.</i>
→ WAV:DATA?	<i>This query returns the raw data acquired from channel 101.</i>
← #800000200<byte1> <byte2>...<byte200>	<i>The acquired data is returned.</i>

ACQure:BURSt

Syntax

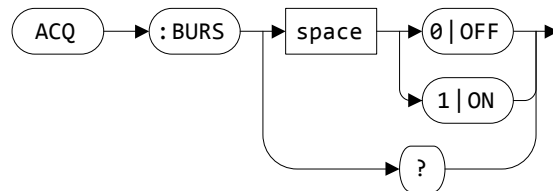
**ACQure:BURSt <mode>**

This command is used to set the burst mode of a multiplexer DAQ device. This mode enables the DAQ device to simulate in simultaneous mode. It would perform sampling measurements at the highest speed of the product capabilities.

ACQure:BURSt?

This query returns a boolean value that represents the state of the burst mode for the AI channels.

- “0” indicates that the burst mode is disabled, and
- “1” indicates that the burst mode is enabled.

NOTE

For more information on enabling the DAQ device to simulate in simultaneous mode, see “Burst mode” in the *Keysight U2300A Series USB Multifunction Data Acquisition Devices User’s Guide*.

Supported models

U2351A, U2352A, U2353A, U2354A, U2355A, U2356A, U2331A

Parameter

Item	Type	Range of values	Default value
mode	Boolean	0 OFF 1 ON	0

Example

→ ACQ: BURS ON	<i>This command enables the burst mode in all AI channels.</i>
→ ACQ: BURS?	<i>This query returns the AI channels burst mode status.</i>
← 1	

THIS PAGE HAS BEEN INTENTIONALLY LEFT BLANK.

3 APPLy Subsystem

APPLy?	40
APPLy:SINusoid	41
APPLy:SQUare	43
APPLy:SAWTooth	45
APPLy:TRIangle	47
APPLy:NOISe	49
APPLy:USER	51

This chapter describes the APPLy commands used to program the U2300A Series DAQ device over a remote interface. Use the APPLy commands to output a sinusoidal, square, sawtooth, triangle, noise, or an arbitrary waveform from the output channels.

APPLy?

Syntax

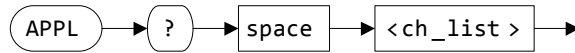

APPLy? <ch_list>

This query returns a series of comma-separated fields indicating the current function, amplitude, and offset value of each analog output (AO) channel specified. The amplitude and offset values returned are expressed in volts (V). The abbreviated form of the function name is always returned.

Supported models

U2351A, U2353A, U2355A, U2356A, U2331A

Parameter

Item	Type	Range of values	Default value
ch_list	Channel list	(@201)(@202)	-

Example

This example illustrates how the **APPLy?** query is used to return the current function, amplitude, and offset value for AO channel 201 and 202.

```
→ APPL? (@201,202)
```

This query returns the current function, amplitude, and offset value for channel 201 and 202.

```
← SIN,10,0,SQU,5,0
```

APPLY:SINusoid

Syntax

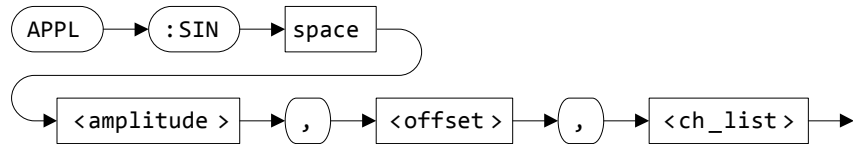

APPLY:SINusoid <amplitude>, <offset>, <ch_list>

This command is used to send a sinusoidal wave with the specified amplitude and DC offset to the instrument buffer. The waveform is generated from the AO channel(s) specified in the <ch_list> parameter after the **OUTPUT ON** command is issued.

Supported models

U2351A, U2353A, U2355A, U2356A, U2331A

Parameters

Item	Type	Range of values	Default value
amplitude	Numeric	[Amplitude value] V ^[a]	10 V
offset	Numeric	[Offset value] V ^[a]	0 V
ch_list	Channel list	(@201)(@202)	-

- [a] The amplitude and offset parameters are subjected to the following constraints:
 Amplitude must be > zero.
 [Amplitude + Offset] must be ≤ 10 and [Amplitude × (-1) + Offset] must be ≥ -10

See also

- “**OUTPUT**” on page 84
- “**OUTPUT:WAVEform:ITERate**” on page 86
- “**OUTPUT:WAVEform:SRATE**” on page 88
- “**OUTPUT:WAVEform:FREQuency**” on page 91
- “**ROUTE:ENABLE**” on page 124

Example

This example illustrates how the **APPLY:SINusoid** command is used to set a 5 V sinusoidal wave with no DC offset for AO channel 201.

→ ROUT:ENAB ON, (@201)	<i>This command enables channel 201 for output operations.</i>
→ APPL:SIN 5,0, (@201)	<i>This command sends a sinusoidal waveform to channel 201 with an amplitude of 5 V (10 V_{pp}) and a DC offset of 0 V.</i>
→ OUTP:WAV:ITER 0	<i>This command causes the instrument to generate the waveform indefinitely.</i>
→ OUTP:WAV:SRAT 0	<i>This command automatically selects a suitable sampling rate for the output waveform.</i>
→ OUTP:WAV:FREQ 5000	<i>This command sets the output waveform frequency to 5 kHz.</i>
→ OUTP ON	<i>This command generates the sinusoidal waveform from channel 201.</i>

APPLY:SQUare

Syntax

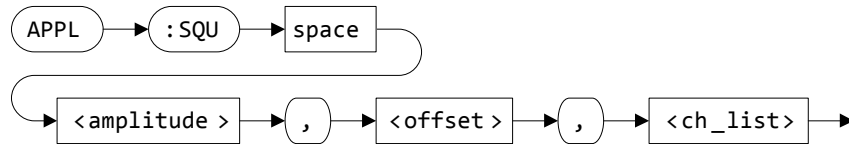

APPLY:SQUare <amplitude>, <offset>, <ch_list>

This command is used to send a square wave with the specified amplitude and DC offset to the instrument buffer. The waveform is generated from the AO channel(s) specified in the <ch_list> parameter after the **OUTPUT ON** command is issued.

Supported models

U2351A, U2353A, U2355A, U2356A, U2331A

Parameters

Item	Type	Range of values	Default value
amplitude	Numeric	[Amplitude value] V ^[a]	10 V
offset	Numeric	[Offset value] V ^[a]	0 V
ch_list	Channel list	(@201)(@202)	-

- [a] The amplitude and offset parameters are subjected to the following constraints:
 Amplitude must be > zero.
 [Amplitude + Offset] must be ≤ 10 and [Amplitude × (-1) + Offset] must be ≥ -10

See also

[“OUTPUT”](#) on page 84

[“OUTPUT:WAVEform:FREQuency”](#) on page 91

[“ROUTE:ENABLE”](#) on page 124

Example

This example illustrates how the **APPLy:SQUare** command is used to set a 3 V square wave with 1 V DC offset for AO channel 202.

→ ROUT:ENAB ON, (@202)	<i>This command enables channel 202 for output operations.</i>
→ APPL:SQU 3,1, (@202)	<i>This command sends a square waveform to channel 202 with an amplitude of 3 V ($6 V_{pp}$) and a DC offset of 1 V.</i>
→ OUTP:WAV:ITER 0	<i>This command causes the instrument to generate the waveform indefinitely.</i>
→ OUTP:WAV:SRAT 0	<i>This command automatically selects a suitable sampling rate for the output waveform.</i>
→ OUTP:WAV:FREQ 5000	<i>This command sets the output waveform frequency to 5 kHz.</i>
→ OUTP ON	<i>This command generates the square waveform from channel 201.</i>

APPLY:SAWTooth

Syntax

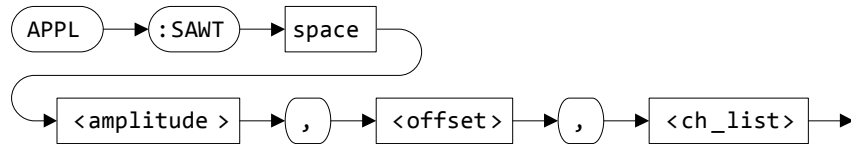

APPLY:SAWTooth <amplitude>, <offset>, <ch_list>

This command is used to send a sawtooth wave with the specified amplitude and DC offset to the instrument buffer. The waveform is generated from the AO channel(s) specified in the <ch_list> parameter after the **OUTPUT ON** command is issued.

Supported models

U2351A, U2353A, U2355A, U2356A, U2331A

Parameters

Item	Type	Range of values	Default value
amplitude	Numeric	[Amplitude value] V ^[a]	10 V
offset	Numeric	[Offset value] V ^[a]	0 V
ch_list	Channel list	(@201)(@202)	-

- [a] The amplitude and offset parameters are subjected to the following constraints:
 Amplitude must be > zero.
 [Amplitude + Offset] must be ≤ 10 and [Amplitude × (-1) + Offset] must be ≥ -10

See also

[“OUTPUT”](#) on page 84

[“OUTPUT:WAVEform:FREQuency”](#) on page 91

[“ROUTE:ENABLE”](#) on page 124

Example

This example illustrates how the **APPLy:SAWTooth** command is used to set a 4.5 V sawtooth waveform with no DC offset for AO channel 202. Note that the settings set by the **OUTPut:WAVeform** commands are applicable in all AO channels.

- **ROUT:ENAB ON, (@201, 202)** *This command enables channel 201 and 202 for output operations.*
- **APPL:SIN 10,0, (@201)** *This command sends a sinusoidal waveform to channel 201 with an amplitude of 10 V (20 V_{pp}) and a DC offset of 0 V.*
- **APPL:SAWT 4.5,0, (@202)** *This command sends a sawtooth waveform to channel 202 with an amplitude of 4.5 V (9 V_{pp}) and a DC offset of 0 V.*
- **OUTP:WAV:ITER 0** *This command causes the instrument to generate the waveform indefinitely.*
- **OUTP:WAV:SRAT 0** *This command automatically selects a suitable sampling rate for the output waveform.*
- **OUTP:WAV:FREQ 5000** *This command sets the output waveform frequency to 5 kHz.*
- **OUTP ON** *This command generates the sinusoidal waveform from channel 201 and the sawtooth waveform from channel 202.*

APPLY:TRiangle

Syntax

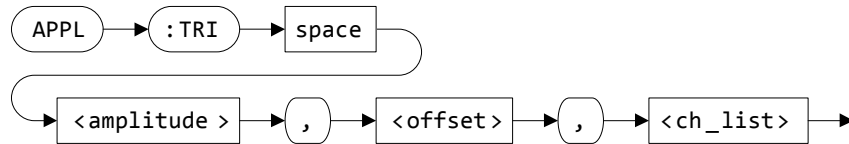

APPLY:TRiangle <amplitude>, <offset>, <ch_list>

This command is used to send a triangle wave with the specified amplitude and DC offset to the instrument buffer. The waveform is generated from the AO channel(s) specified in the <ch_list> parameter after the **OUTPUT ON** command is issued.

Supported models

U2351A, U2353A, U2355A, U2356A, U2331A

Parameters

Item	Type	Range of values	Default value
amplitude	Numeric	[Amplitude value] V ^[a]	10 V
offset	Numeric	[Offset value] V ^[a]	0 V
ch_list	Channel list	(@201)(@202)	-

- [a] The amplitude and offset parameters are subjected to the following constraints:
 Amplitude must be > zero.
 [Amplitude + Offset] must be ≤ 10 and [Amplitude × (-1) + Offset] must be ≥ -10

See also

[“OUTPUT”](#) on page 84

[“OUTPUT:WAVEform:FREQuency”](#) on page 91

[“ROUTE:ENABLE”](#) on page 124

Example

This example illustrates how the **APPLY:TRIangle** command is used to set a 5 V triangle wave with -2 V DC offset for AO channel 201.

- **ROUT:ENAB ON, (@201)** *This command enables channel 201 for output operations.*
- **APPL:TRI 5, -2, (@201)** *This command sends a triangle waveform to channel 201 with an amplitude of 5 V (10 V_{pp}) and a DC offset of -2 V.*
- **OUTP:WAV:ITER 0** *This command causes the instrument to generate the waveform indefinitely.*
- **OUTP:WAV:SRAT 0** *This command automatically selects a suitable sampling rate for the output waveform.*
- **OUTP:WAV:FREQ 5000** *This command sets the output waveform frequency to 5 kHz.*
- **OUTP ON** *This command generates the triangle waveform from channel 201.*

APPLY:NOISe

Syntax

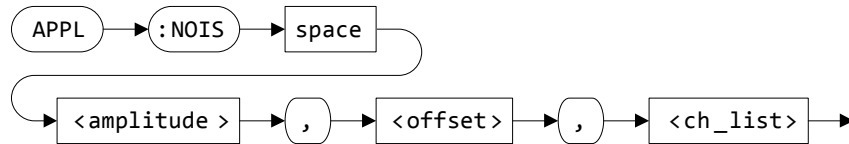

APPLY:NOISe <amplitude>, <offset>, <ch_list>

This command is used to send a noise wave with the specified amplitude and DC offset to the instrument buffer. The waveform is generated from the AO channel(s) specified in the <ch_list> parameter after the **OUTPUT ON** command is issued.

Supported models

U2351A, U2353A, U2355A, U2356A, U2331A

Parameters

Item	Type	Range of values	Default value
amplitude	Numeric	[Amplitude value] V ^[a]	10 V
offset	Numeric	[Offset value] V ^[a]	0 V
ch_list	Channel list	(@201)(@202)	-

- [a] The amplitude and offset parameters are subjected to the following constraints:
 Amplitude must be > zero.
 [Amplitude + Offset] must be ≤ 10 and [Amplitude × (-1) + Offset] must be ≥ -10

See also

“**OUTPUT**” on page 84

“**OUTPUT:WAVEform:FREQuency**” on page 91

“**ROUTE:ENABLE**” on page 124

Example

This example illustrates how the **APPLy:NOISe** command is used to set a 10 V noise wave with no DC offset for AO channel 201 and 202. Note that the settings set by the **OUTPut:WAVeform** commands are applicable in all AO channels.

→ ROUT:ENAB ON, (@201,202)	<i>This command enables channel 201 and 202 for output operations.</i>
→ APPL:NOIS 10,0, (@201,202)	<i>This command sends a noise waveform to channel 201 and 202 with an amplitude of 10 V (20 V_{pp}) and a DC offset of 0 V.</i>
→ OUTP:WAV:ITER 0	<i>This command causes the instrument to generate the waveform indefinitely.</i>
→ OUTP:WAV:SRAT 0	<i>This command automatically selects a suitable sampling rate for the output waveform.</i>
→ OUTP:WAV:FREQ 5000	<i>This command sets the output waveform frequency to 5 kHz.</i>
→ OUTP ON	<i>This command generates the noise waveform from channel 201 and 202.</i>

APPLY:USER

Syntax

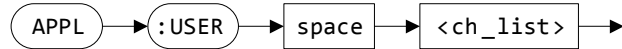

APPLY:USER <ch_list>

This command is used to send a user-defined pattern to the instrument buffer. The arbitrary waveform is generated from the AO channel(s) specified in the <ch_list> parameter after the **OUTPUT ON** command is issued.

NOTE

For more information on how to send a user-defined pattern to the instrument buffer see **"DATA[:USER]"** on page 219.

Supported models

U2351A, U2353A, U2355A, U2356A, U2331A

Parameters

Item	Type	Range of values	Default value
ch_list	Channel list	(@201)(@202)	-

Remarks

- The **OUTPUT ON** command will return an error if channel 201 and 202 is configured to user-defined and predefined (**SIN**, **SQU**, **SAWT**, **TRI**, or **NOIS**) waveform patterns at the same time.
- You cannot output a user-defined pattern if the waveform sampling rate is set to automatic (**OUTPUT:WAVEform:SRATE 0**). To select an AO waveform sampling rate value, see **"OUTPUT:WAVEform:SRATE"** on page 88.

See also

“OUTPut:WAVeform:SRATe” on page 88

“ROUTe:ENABLE” on page 124

“DATA[:USER]” on page 219

Example

This example illustrates how the **DATA[:USER]** command is used with the **APPL:USER** command to output an arbitrary waveform via channel 201.

- **ROUT:ENAB OFF, (@202)** *This command disables output operations for channel 202. This ensures that we do not accidentally output a predefined waveform from channel 202.*
- **ROUT:ENAB ON, (@201)** *This command enables output operations for channel 201.*
- **DATA #800002000<byte1>
<byte2>...<byte2000>** *This command sends 1000 points (2000 bytes) of user-defined data to the instrument buffer.*
- **OUTP:WAV:ITER 0** *This command causes the instrument to generate the waveform indefinitely.*
- **OUTP:WAV:SRAT 2000** *This command sets the AO waveform sampling rate to 2 kHz.*
- **APPL:USER (@201)** *This command sends the user-defined pattern to channel 201.*
- **OUTP ON** *This command generates the user-defined pattern from channel 201.*

4 CALibration Subsystem

CALibration:BEIn 54

This chapter describes the CALibration command used to program the U2300A Series DAQ device over a remote interface. Use the CALibration:BEIn command to carry out the self-calibration function on your DAQ device.

CALibration:BEgin

Syntax

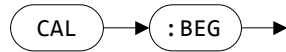

CALibration:BEgin

This command is used to calibrate your DAQ device. When this command is executed, the DAQ device goes into a self-calibration mode.

NOTE

For more information on the self-calibration procedures, see Chapter 5, “Calibration” in the *Keysight U2300A Series USB Multifunction Data Acquisition Devices User’s Guide*.

Supported models

U2351A, U2352A, U2353A, U2354A, U2355A, U2356A, U2331A

Remarks

The functions of the DAQ device will be halted until the self-calibration process is completed. Use the ***OPC?** query to check if the calibration is completed. The calibration is complete if the returned value is “+1”.

Example

This example illustrates how the **CALibration:BEgin** command is used to begin the self-calibration process.

→ CAL:BEG

This command begins the self-calibration process.

→ *OPC?

← +1

The returned value “+1” indicates that the self-calibration process has been completed.

5 CONFigure Subsystem

CONFigure:DIGital:DIRection	56
CONFigure:TIMEbase:SOURce	58
CONFigure:TIMEbase:ECLock	60
CONFigure:SSI	62

This chapter describes the CONFigure commands used to program the U2300A Series DAQ device over a remote interface. Use the CONFigure:DIGital:DIRection command to set the digital port for input or output operations. You can also select a clock source for both AI and AO channels.

CONFigure:DIgital:DIRection

Syntax

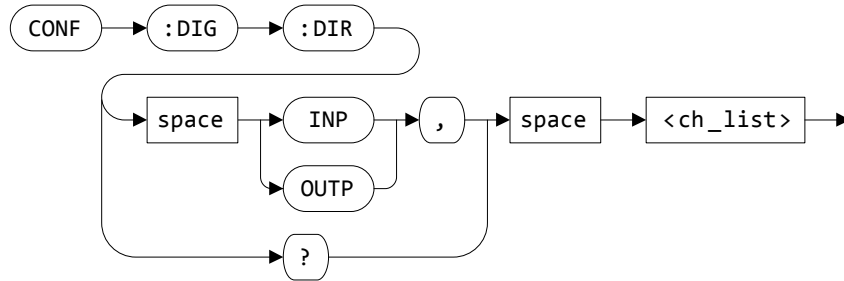

CONFigure:DIgital:DIRection <direction>, <ch_list>

This command is used to set the digital port direction for the digital input/output (DIO) channel(s) specified in the <ch_list> parameter.

The valid options are:

- INPut: Configures channel for input operations.
- OUTPut: Configures channel for output operations.

CONFigure:DIgital:DIRection? <ch_list>

This query returns a string value that represents the digital port direction of each DIO channel specified. Multiple responses are separated by commas.

Supported models

U2351A, U2352A, U2353A, U2354A, U2355A, U2356A, U2331A

Parameters

Item	Type	Range of values	Default value
direction	Discrete	INPut OUTPut	INPut
ch_list	Channel list	(@501)(@502)(@503)(@504)	-

Example

This example illustrates how the **CONFigure:DIGital:DIRection** command is used to enable output operations for channel 501.

→ CONF:DIG:DIR OUTP, (@501)	<i>This command enables output operations for channel 501.</i>
→ CONF:DIG:DIR? (@501:503)	<i>This query returns the digital port direction for channel 501, 502, and 503.</i>
← OUTP, INP, INP	<i>The returned value for channel 501 is "OUTP", indicating output operations; whereas the returned value for channel 502 and 503 is "INP", indicating input operations.</i>

CONFigure:TIMEbase:SOURce

Syntax

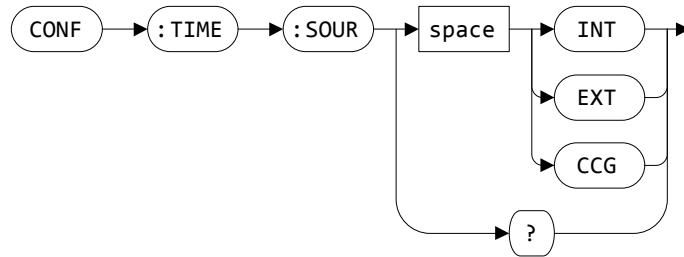
**CONFigure:TIMEbase:SOURce <mode>**

This command is used to set the timebase/clock source for both AI and AO channels.

The valid options are:

- INTERNAL: Selects the DAQ device internal clock frequency as the timebase/clock source.
- EXTERNAL: Selects the EXT_TIMEBASE pin as the timebase/clock source.

NOTE

- The clock frequency coming in from the EXT_TIMEBASE pin must be set in the DAQ device via the **CONFigure:TIMEbase:ECLock** command. For example, if a 10 MHz clock frequency is expected from the EXT_TIMEBASE pin, you must send the **CONFigure:TIMEbase:ECLock 10000** command to the DAQ device.
- See **“CONFigure:TIMEbase:ECLock”** on page 60 for more information on how to set the external clock frequency.

- CCG (Card cage): Selects the U2781A USB modular instrument chassis clock frequency as the timebase/clock source.

CONFigure:TIMEbase:SOURce?

This query returns a string value that represents the timebase/clock source for both AI and AO channels.

Supported models

U2351A, U2352A, U2353A, U2354A, U2355A, U2356A, U2331A

Parameter

Item	Type	Range of values	Default value
mode	Discrete	INTernal EXTernal CCG	INTernal

See also

[“CONFigure:TIMEbase:ECLock”](#) on page 60

Example

This example illustrates how the **CONFigure:TIMEbase:SOURce** command is used to set the AI and AO channels timebase/clock source to the EXT_TIMEBASE pin.

```

→ CONF:TIME:SOUR EXT      This command sets the instrument timebase/
                           clock source to the EXT_TIMEBASE pin.
                           A 20 MHz clock frequency signal is supplied to
                           the EXT_TIMEBASE pin.

→ CONF:TIME:ECLK 20000    Since we are expecting a 20 MHz clock
                           frequency from the EXT_TIMEBASE pin, this
                           command is used to set the external clock
                           frequency to 20 MHz.

→ CONF:TIME:SOUR?        This query returns the timebase/clock source
                           for the AI and AO channels.

← EXT

```

CONFigure:TIMEbase:ECLock

Syntax

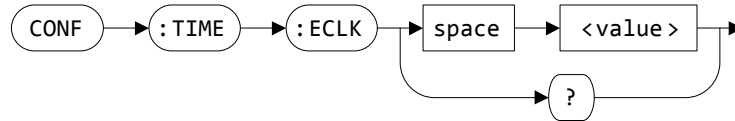

CONFigure:TIMEbase:ECLock <value>

This command is used to set the external clock frequency. The frequency set in the **<value>** parameter must be the same as the frequency value supplied to the EXT_TIMEBASE pin when the timebase/clock source is set to **EXTernal**. The clock frequency is expressed in units of kilohertz (kHz).

NOTE

See **“CONFigure:TIMEbase:SOURce”** on page 58 for more information on selecting a timebase/clock source.

CONFigure:TIMEbase:ECLock?

This query returns a numeric value that represents the external clock frequency. The value returned is expressed in kilohertz (kHz).

Supported models

U2351A, U2352A, U2353A, U2354A, U2355A, U2356A, U2331A

Parameter

Item	Type	Range of values	Default value
value	Discrete	10000 kHz (10 MHz) to 48000 kHz (48 MHz)	10000 kHz

See also

“CONFigure:TIMEbase:SOURce” on page 58

Example

This example illustrates how the **CONFigure:TIMEbase:ECLock** command is used to set the external clock frequency.

→ CONF:TIME:SOUR EXT	<i>This command sets the instrument timebase/clock source to the EXT_TIMEBASE pin. A 20 MHz clock frequency signal is supplied to the EXT_TIMEBASE pin.</i>
→ CONF:TIME:ECLK 20000	<i>Since we are expecting a 20 MHz clock frequency from the EXT_TIMEBASE pin, this command is used to set the external clock frequency to 20 MHz.</i>
→ CONF:TIME:ECLK?	<i>This query returns the external clock frequency for the AI and AO channels.</i>
← 20000	

CONFigure:SSl

Syntax

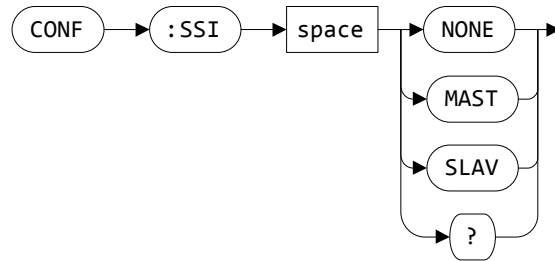
**CONFigure:SSl <mode>**

This command is used to set or disable the simultaneous synchronization status of the DAQ device when used in the U2781A USB modular instrument chassis.

The valid options are:

- NONE: Disables the SSI state.
- MAST (Master): Configures the module to drive the triggering signal onto the common trigger bus.
- SLAV (Slave): Configures the module as a listener. The module will monitor the common trigger bus for any incoming triggering signals.

CONFigure:SSl?

This query returns a string value that represents the simultaneous synchronization status of the DAQ device when used in the U2781A USB modular instrument chassis.

Supported models

U2351A, U2352A, U2353A, U2354A, U2355A, U2356A, U2331A

Parameter

Item	Type	Range of values	Default value
mode	Discrete	NONE MAST SLAV	NONE

NOTE

- This command is only operational when used in the U2781A USB modular instrument chassis.
- There should only be one master assigned at any one time.
- For more information on the Synchronous Simultaneous Interface (SSI), refer to the *U2781A USB Modular Instrument Chassis User's Guide*.

Remarks

- This command will force all reference clock sources to the synchronous simultaneous interface.
- Once a module is configured as a slave (**CONFigure:SSI SLAV**), it becomes a listener and listens for a triggering signals on the backplane of the U2781A chassis. To undo this listener behavior, a **CONFigure:SSI NONE** command must be issued to the slave module.

Example

This example illustrates how the **CONFigure:SSI** command is used to set the DAQ device as a slave module to monitor incoming triggering signals when used in the U2781A USB modular instrument chassis.

→ SYST:CDES?	<i>This query returns the slot and chassis number that the DAQ device is plugged into.</i>
← 2,1	<i>The returned value "2,1" indicates that the DAQ device is slotted into the second slot of the first chassis.</i>
→ CONF:SSI SLAV	<i>This command sets the synchronization status of the instrument as a slave.</i>

THIS PAGE HAS BEEN INTENTIONALLY LEFT BLANK.

6 MEASure Subsystem

MEASure[:VOLTage][:DC]? 66
MEASure:COUNter:DATA? 68
MEASure:COUNter:FREQuency? 70
MEASure:COUNter:PERiod? 72
MEASure:COUNter:PWIDth? 74
MEASure:COUNter:TOTAlize? 76
MEASure:DIGital? 78
MEASure:DIGital:BIT? 80

This chapter describes the MEASure commands used to program the U2300A Series DAQ device over a remote interface. Use the MEASure[:VOLTage][:DC]? query to make a single voltage measurement. You can also return the frequency, period, pulse width, and totalizer values.

MEASure[:VOLTage][:DC]?

Syntax

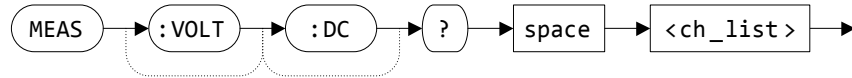

MEASure[:VOLTage][:DC]? <ch_list>

This query is used to make a single voltage measurement. This query returns a numeric value that represents the scaled voltage value from each AI channel specified. Multiple responses are separated by commas. The value returned is expressed in volts (V).

Supported models

U2351A, U2352A, U2353A, U2354A, U2355A, U2356A, U2331A

Parameter

Item	Type	Range of values	Default value
ch_list	Channel list	Single-ended mode: - U2351A/52A/53A/54A: (@101) to (@116) - U2355A/U56A/31A: (@101) to (@164) Differential mode: - U2351A/52A/53A/54A: (@101) to (@108) - U2355A/56A/31A: (@101) to (@132)	-

Remarks

- If the returned value is **999.9** V, the measurement voltage is out of range.
- To set the measurement range, polarity, or signal type of an AI channel, use the [SENSe:]VOLTage:RANGe, [SENSe:]VOLTage:POLarity, and [SENSe:]VOLTage:STYPe commands.

See also

[“\[SENSe:\]VOLTage:RANGe”](#) on page 128

[“\[SENSe:\]VOLTage:POLarity”](#) on page 131

[“\[SENSe:\]VOLTage:STYPe”](#) on page 133

Example

This example illustrates how the **MEASure[:VOLTage][:DC]?** query is used to acquire a single voltage reading from AI channels 105 to 107.

→ **MEAS? (@105:107)**

This query returns a single voltage measurement from channel 105, 106, and 107.

← **20.3,40.1,999.9**

A single voltage reading is returned from each specified channel. The returned value “999.9” for channel 107 indicates that the measurement voltage is out of range.

MEASure:COUNter:DATA?

Syntax

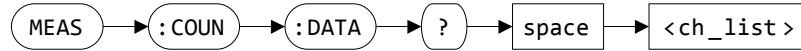

MEASure:COUNter:DATA? <ch_list>

This query returns a numeric value that represents the value of the specific counter function selected (frequency, period, pulse width, or totalizer). The value returned is based on the current counter function the counter channel specified. Multiple responses are separated by commas.

NOTE

For more information on selecting a counter function, see “[SENSe:]COUNter:FUNction” on page 136.

Supported models

U2351A, U2352A, U2353A, U2354A, U2355A, U2356A, U2331A

Parameter

Item	Type	Range of values	Default value
ch_list	Channel list	(@301) (@302)	-

See also

“[SENSe:]COUNter:FUNction” on page 136

Example

This example illustrates how the **MEASure:COUNter:DATA?** query is used to return the counter value for the specified counting mode selected by the **[SENSe:]COUNter:FUNction** command.

→ **COUN:FUNC FREQ, (@301)** *This command sets channel 301 to measure frequency.*

→ **MEAS:COUN:DATA? (@301)** *This query returns the frequency for channel 301.*

← **5.599627** *The frequency is returned in kHz.*

→ **COUN:FUNC PER, (@301)** *This command sets channel 301 to measure period.*

→ **MEAS:COUN:DATA? (@301)** *This query returns the period for channel 301.*

← **0.1818333** *The period is returned in ms.*

→ **COUN:FUNC PWID, (@302)** *This command sets channel 302 to measure pulse width.*

→ **MEAS:COUN:DATA? (@302)** *This query returns the pulse width for channel 302.*

← **0.12725** *The pulse width is returned in ms.*

MEASure:COUNter:FREQuency?

Syntax

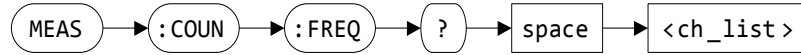

MEASure:COUNter:FREQuency? <ch_list>

This query returns a numeric value that represents the frequency of each counter channel specified. Multiple responses are separated by commas. The value returned is expressed in kilohertz (kHz).

Supported models

U2351A, U2352A, U2353A, U2354A, U2355A, U2356A, U2331A

Parameter

Item	Type	Range of values	Default value
ch_list	Channel list	(@301)(@302)	-

Remarks

- Executing the **MEASure:COUNter:FREQuency?** query will automatically change the current function of the counter channel specified. You do not need to select the frequency measurement function (via the **SENSe:COUNter:FUNction FREQuency** command) prior to sending this command.
- Alternatively, you may also use the **MEASure:COUNter:DATA?** query to return a frequency reading if the specified counter channel function is already set to measure frequency.

See also

[“MEASure:COUNter:DATA?”](#) on page 68

[“\[SENSe:\]COUNter:FUNction”](#) on page 136

Example

This example illustrates how the **MEASure:COUNter:FREQuency?** query is used to return the frequency measurement for channel 301.

→ **COUN:FUNC?(@301)** *This query returns the current counter function for channel 301.*

← **PER** *The returned value “PER” indicates that channel 301 is currently set to measure the period.*

→ **MEAS:COUN:FREQ?(@301)** *This query returns the frequency for channel 301. This query also changes the counter function.*

← **5.599627** *The frequency is returned in kHz.*

→ **COUN:FUNC?(@301)**

← **FREQ** *The returned value “FREQ” indicates that channel 301 is now set to measure the frequency.*

MEASure:COUNter:PERiod?

Syntax

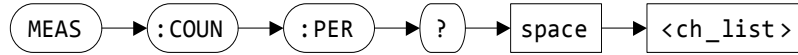

MEASure:COUNter:PERiod? <ch_list>

This query returns a numeric value that represents the period of each counter channel specified. Multiple responses are separated by commas. The value returned is expressed in milliseconds (ms).

Supported models

U2351A, U2352A, U2353A, U2354A, U2355A, U2356A, U2331A

Parameter

Item	Type	Range of values	Default value
ch_list	Channel list	(@301) (@302)	-

Remarks

- Executing the **MEASure:COUNter:PERiod?** query will automatically change the current function of the counter channel specified. You do not need to select the period measurement function (via the **SENSe:COUNter:FUNction PERiod** command) prior to sending this command.
- Alternatively, you may also use the **MEASure:COUNter:DATA?** query to return a period reading if the specified counter channel function is already set to measure the period.

See also

[“MEASure:COUNter:DATA?”](#) on page 68

[“\[SENSe:\]COUNter:FUNction”](#) on page 136

Example

This example illustrates how the **MEASure:COUNter:PERiod?** query is used to return the period measurement for channel 301.

→ **MEAS:COUN:PER? (@301)** *This query returns the period for channel 301.*

← **0.1818333** *The period is returned in ms.*

MEASure:COUNter:PWIDth?

Syntax

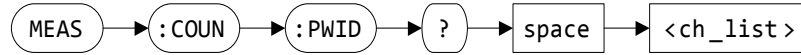

MEASure:COUNter:PWIDth? <ch_list>

This query returns a numeric value that represents the pulse width of each counter channel specified. Multiple responses are separated by commas. The value returned is expressed in milliseconds (ms).

Supported models

U2351A, U2352A, U2353A, U2354A, U2355A, U2356A, U2331A

Parameter

Item	Type	Range of values	Default value
ch_list	Channel list	(@301) (@302)	-

Remarks

- Executing the **MEASure:COUNter:PWIDth?** query will automatically change the current function of the counter channel specified. You do not need to select the pulse width measurement function (via the **SENSe:COUNter:FUNCTION PWIDth** command) prior to sending this command.
- Alternatively, you may also use the **MEASure:COUNter:DATA?** query to return a pulse width reading if the specified counter channel function is already set to measure the pulse width.

See also

[“MEASure:COUNter:DATA?”](#) on page 68

[“\[SENSe:\]COUNter:FUNCTION”](#) on page 136

Example

This example illustrates how the **MEASure:COUNter:PWIDth?** query is used to return the pulse width for channel 301.

→ **MEAS:COUN:PWID? (@301)** *This query returns the pulse width for channel 301.*

← **0.12725** *The pulse width is returned in ms.*

MEASure:COUNTER:TOTAlize?

Syntax

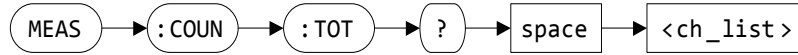

MEASure:COUNTER:TOTAlize? <ch_list>

This query returns a numeric value that represents the totalized value of each counter channel specified. Multiple responses are separated by commas.

Supported models

U2351A, U2352A, U2353A, U2354A, U2355A, U2356A, U2331A

Parameter

Item	Type	Range of values	Default value
ch_list	Channel list	(@301) (@302)	-

Remarks

- Executing the **MEASure:COUNTER:TOTAlize?** query will automatically change the current function of the counter channel specified. You do not need to select the totalize measurement function (via the **SENSe:COUNTER:FUNctIon TOTAlize** command) prior to sending this command.
- Alternatively, you may also use the **MEASure:COUNTER:DATA?** query to return a totalized reading if the specified counter channel function is already set to the totalizer measurement function.

See also

[“MEASure:COUNTER:DATA?”](#) on page 68

[“\[SENSe:\]COUNTER:FUNctIon”](#) on page 136

Example

This example illustrates how the **MEASure:COUNter:TOTalize?** query is used to return the totalized value for channel 301.

→ *CLS; *RST	<i>These commands clear and reset the instrument to its default settings.</i>
→ COUN:TOT:INIT (@301)	<i>This command starts the totalizer measurement on channel 301 with the instrument default values.</i>
→ COUN:GATE:CONT ENAB, (@301)	<i>This command enables the gate of channel 301. The input signals are now allowed to pass.</i>
→ MEAS:COUN:TOT? (@301)	<i>This query returns the totalized value of the input signals for channel 301.</i>
← 56001	<i>The totalized value thus far is returned.</i>

MEASure:DIgital?

Syntax



MEASure:DIgital? <ch_list>

This query returns a numeric value that represents the digital data of each DIO channel specified. Multiple responses are separated by commas. The specified DIO channels have to be configured as **INPut**, prior to returning any digital data.

NOTE

To configure the DIO channel for input operation, see [“CONFigure:DIgital:DIRection”](#) on page 56.

Supported models

U2351A, U2352A, U2353A, U2354A, U2355A, U2356A, U2331A

Parameter

Item	Type	Range of values	Default value
ch_list	Channel list	(@501)(@502)(@503)(@504)	-

Remarks

- Channel 501 and 502 returns a value from 0 to 255 (8-bits).
- Channel 503 and 504 returns a value from 0 to 15 (4-bits).

See also

[“CONFigure:DIgital:DIRection”](#) on page 56

Example

This example illustrates how the **MEASure:DIGital?** query is used to return the digital data for DIO channel 501.

→ CONF:DIG:DIR INP, (@501)	<i>This command enables input operations for channel 501.</i>
→ MEAS:DIG? (@501)	<i>This query returns the digital data for channel 501.</i>
← 2	<i>The returned value "2" indicates that bit 2 of channel 501 is at logic high.</i>

MEASure:DIGital:BIT?

Syntax

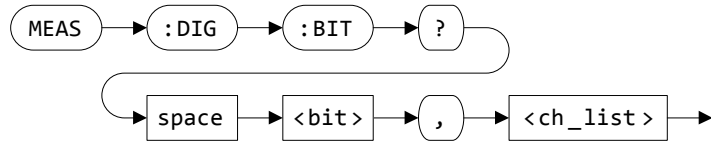

MEASure:DIGital:BIT? <bit>, <ch_list>

This query returns a boolean value that represents the digital logic state of the specified bit of each DIO channel specified. Multiple responses are separated by commas. The specified DIO channels have to be configured as **INPut**, prior to returning any digital data.

NOTE

To configure the DIO channel for input operation, see “**CONFigure:DIGital:DIRection**” on page 56.

Supported models

U2351A, U2352A, U2353A, U2354A, U2355A, U2356A, U2331A

Parameter

Item	Type	Range of values	Default value
bit	Numeric	<ul style="list-style-type: none"> - Channel 501 and 502: Bit 0 to 7 - Channel 503 and 504: Bit 0 to 3 	-
ch_list	Channel list	(@501)(@502)(@503)(@504)	-

Remarks

Channel 501 and 502 are of 8-bit length, while channel 503 and 504 are of 4-bit length.

See also

“CONFigure:DIGital:DIRection” on page 56

“MEASure:DIGital?” on page 78

Example

This example illustrates how the **MEASure:DIGital:BIT?** query is used to return the digital logic state of bit 2 for DIO channel 501.

→ CONF:DIG:DIR INP, (@501)	<i>This command enables input operations for channel 501.</i>
→ MEAS:DIG? (@501)	<i>This query returns the digital data for channel 501.</i>
← 2	<i>The returned value “2” indicates that bit 2 of channel 501 is at logic high.</i>
→ MEAS:DIG:BIT? 2, (@501)	<i>This query returns the digital logic state of bit 2 for channel 501.</i>
← 1	

THIS PAGE HAS BEEN INTENTIONALLY LEFT BLANK.

7 OUTPUT Subsystem

OUTPut	84
OUTPut:WAVEform:ITERate	86
OUTPut:WAVEform:SRATE	88
OUTPut:WAVEform:FREQuency	91
OUTPut:TRIGger:SOURce	93
OUTPut:TRIGger:TYPe	95
OUTPut:TRIGger:DCouNT	97
OUTPut:TRIGger:ATRIgger:SOURce	99
OUTPut:TRIGger:ATRIgger:CONDition	102
OUTPut:TRIGger:ATRIgger:HTHReshold	105
OUTPut:TRIGger:ATRIgger:LTHReshold	107
OUTPut:TRIGger:DTRIGger:POLarity	109

This chapter describes the OUTPut commands used to program the U2300A Series DAQ device over a remote interface. Use the OUTPut command to enable or disable the analog output. You can also set the AO trigger settings.

OUTPut

Syntax

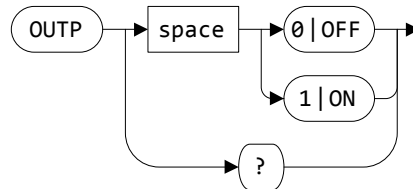

OUTPut <mode>

This command is used to enable or disable the analog output.

OUTPut?

This query returns a boolean value that represents the status of the analog output.

- “0” indicates that the output is disabled, and
- “1” indicates that the output is enabled.

Supported models

U2351A, U2353A, U2355A, U2356A, U2331A

Parameter

Item	Type	Range of values	Default value
mode	Boolean	0 OFF 1 ON	0

Remarks

- The **OUTPut ON** and **OUTPut OFF** commands cannot be executed repeatedly.
- You cannot generate a predefined and a user-defined waveform at the same time.

See also

“[OUTPut:WAVEform:ITERate](#)” on page 86

“[OUTPut:WAVEform:SRATe](#)” on page 88

“[OUTPut:WAVEform:FREQuency](#)” on page 91

Example

This example illustrates how the **OUTPut** command is used to generate a 5 V sinusoidal wave with no DC offset from AO channel 201.

- | | |
|-------------------------------------|---|
| → <code>ROUT:ENAB ON, (@201)</code> | <i>This command enables channel 201 for output operations.</i> |
| → <code>APPL:SIN 5,0, (@201)</code> | <i>This command sends a sinusoidal waveform to channel 201 with an amplitude of 5 V (10 V_{pp}) and a DC offset of 0 V.</i> |
| → <code>OUTP:WAV:ITER 0</code> | <i>This command causes the instrument to generate the waveform indefinitely.</i> |
| → <code>OUTP:WAV:SRAT 0</code> | <i>This command automatically selects a suitable sampling rate for the output waveform.</i> |
| → <code>OUTP:WAV:FREQ 5000</code> | <i>This command sets the output waveform frequency to 5 kHz.</i> |
| → <code>OUTP ON</code> | <i>This command generates the sinusoidal waveform from channel 201.</i> |

OUTPUT:WAVEform:ITERate

Syntax

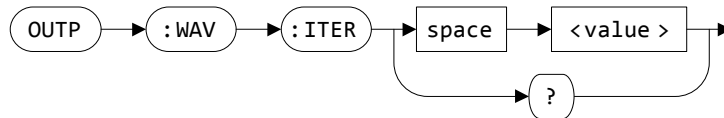

OUTPUT:WAVEform:ITERate <value>

This command is used to set the number of waveform iterations in the AO buffer.

OUTPUT:WAVEform:ITERate?

This query returns a numeric value that represents the waveform iteration count.

Supported models

U2351A, U2353A, U2355A, U2356A, U2331A

Parameter

Item	Type	Range of values	Default value
value	Numeric	0 to 16777215 (24-bits) ^[a]	0 (Infinite iteration)

[a] The iteration parameter is subjected to the following constraints:

- Iteration ≥ 0
- Iteration < 0xfffff

Remarks

Default value zero causes the DAQ device to generate the waveform indefinitely.

See also

“OUTPUT” on page 84

“OUTPUT:WAVEform:SRATE” on page 88

“OUTPUT:WAVEform:FREQuency” on page 91

Example

This example illustrates how the **OUTPut:WAVEform:ITERation** command is used to generate 256 iterations of a 5 V sinusoidal wave with no DC offset for AO channel 201.

- **ROUT:ENAB ON, (@201)** *This command enables channel 201 for output operations.*
- **APPL:SIN 5,0, (@201)** *This command sends a sinusoidal waveform to channel 201 with an amplitude of 5 V (10 V_{pp}) and a DC offset of 0 V.*
- **OUTP:WAV:ITER 256** *This command sets an iteration value of 256 for the output waveform. This implies that channel 201 will generate a full sinusoidal wave 256 times when the OUTP ON command is issued.*
- **OUTP:WAV:SRAT 0** *This command automatically selects a suitable sampling rate for the output waveform.*
- **OUTP:WAV:FREQ 5000** *This command sets the output waveform frequency to 5 kHz.*
- **OUTP ON** *This command generates the sinusoidal waveform for 256 iterations from channel 201.*

OUTPut:WAVeform:SRATe

Syntax

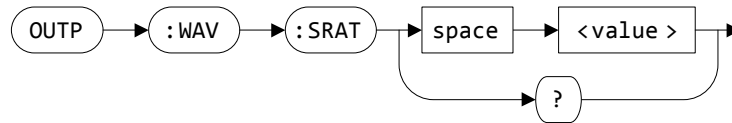

OUTPut:WAVeform:SRATe <value>

This command is used to set the waveform sampling rate of the analog output.

OUTPut:WAVeform:SRATe?

This query returns a numeric value that represents the waveform sampling rate. The value returned is expressed in hertz (Hz).

Supported models

U2351A, U2353A, U2355A, U2356A, U2331A

Parameter

Item	Type	Range of values	Default value
value	Numeric	(48/16777215) Hz to 1000000 Hz (1 MHz) ^[a]	0 (Infinite iteration)

[a] The sampling rate parameter is subjected to the following constraints:

$0 \leq \text{Sampling rate} \leq 10^6$

Sampling rate $\geq (48 \times 10^6 / 0\text{xfffff})$

Remarks

- Default value zero causes the DAQ device to automatically select a suitable waveform sampling rate for predefined waveform (**SINusoid**, **SQUare**, **SAWTooth**, **TRIangle**, and **NOISe**) generation.
- The U2300A Series DAQ device can output a maximum of 4096 points for a single waveform.
- The relationship between the waveform sampling rate, waveform frequency, and number of points in a waveform is defined by:

$$\text{Waveform points} = \frac{\text{Waveform sampling rate}}{\text{Waveform frequency}} \quad (1)$$

NOTE

- Use the `OUTPut:WAVEform:FREQUENCY` command to set the waveform frequency.
- Using a lower waveform sampling rate will increase the duration taken to generate a waveform. You are encouraged to use the default automatic sampling configuration by sending the `OUTPut:WAVEform:SRATE 0` command for predefined waveform generation.

See also

“OUTPut” on page 84

“OUTPut:WAVEform:ITERate” on page 86

“OUTPut:WAVEform:FREQUENCY” on page 91

Example

This example illustrates how the **OUTPUT:WAVEform:SRATE** command is used to generate a 5 V sinusoidal wave with no DC offset for AO channel 201 with a sampling rate of 500 kHz.

- **ROUT:ENAB ON, (@201)** *This command enables channel 201 for output operations.*
- **APPL:SIN 5,0, (@201)** *This command sends a sinusoidal waveform to channel 201 with an amplitude of 5 V (10 V_{pp}) and a DC offset of 0 V.*
- **OUTPUT:WAV:ITER 0** *This command causes the instrument to generate the waveform indefinitely.*
- **OUTPUT:WAV:SRAT 500000** *This command selects an 500 kHz sampling rate for the output waveform. This implies that the sinusoidal waveform is generated with 100 points (500 kHz / 5 kHz) for each cycle.*
- **OUTPUT:WAV:FREQ 5000** *This command sets the output waveform frequency to 5 kHz.*
- **OUTPUT ON** *This command generates the sinusoidal waveform from channel 201.*

OUTPut:WAVeform:FREQuency

Syntax

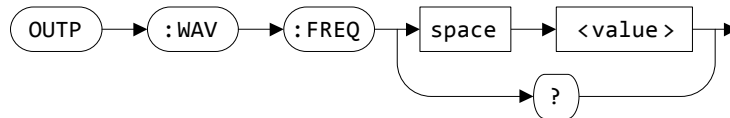

OUTPut:WAVeform:FREQuency <value>

This command is used to set the analog output frequency.

OUTPut:WAVeform:FREQuency?

This query returns a numeric value that represents the frequency value for the analog outputs. The returned value is expressed in hertz (Hz).

Supported models

U2351A, U2353A, U2355A, U2356A, U2331A

Parameter

Item	Type	Range of values	Default value
value	Numeric	10 Hz to 10000 Hz (10 kHz)	4000 Hz (4 kHz)

See also

[“OUTPut”](#) on page 84

[“OUTPut:WAVeform:ITERate”](#) on page 86

[“OUTPut:WAVeform:SRATe”](#) on page 88

Example

This example illustrates how the **OUTPUT:WAVEform:FREQuency** command is used to generate a 10 kHz 5 V sinusoidal wave with no DC offset for AO channel 201.

→ ROUT:ENAB ON, (@201)	<i>This command enables channel 201 for output operations.</i>
→ APPL:SIN 5,0, (@201)	<i>This command sends a sinusoidal waveform to channel 201 with an amplitude of 5 V (10 V_{pp}) and a DC offset of 0 V.</i>
→ OUTPUT:WAV:ITER 0	<i>This command causes the instrument to generate the waveform indefinitely.</i>
→ OUTPUT:WAV:SRAT 0	<i>This command automatically selects a suitable sampling rate for the output waveform.</i>
→ OUTPUT:WAV:FREQ 10000	<i>This command sets the output waveform frequency to 10 kHz.</i>
→ OUTPUT ON	<i>This command generates the sinusoidal waveform from channel 201.</i>

OUTPut:TRIGger:SOURce

Syntax

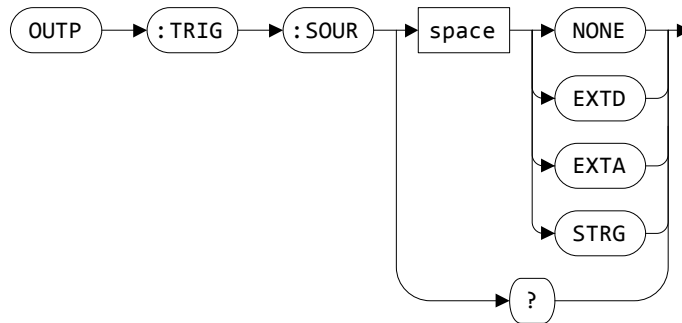

OUTPut:TRIGger:SOURce <mode>

This command is used to set the trigger source for output operations.

The valid options are:

- NONE: Immediate triggering.
- EXTD: Selects the external digital trigger (EXTD_AO_TRIG) pin as the triggering source.
- EXTA: Selects the external analog trigger as the triggering source. See “OUTPut:TRIGger:ATRIGger:SOURce” on page 99 for more information on setting the analog trigger source.
- STRG: Star triggering.

NOTE

- Star triggering (STRG) is used when the DAQ device is connected into the U2781A USB modular instrument chassis.
- For more information on selecting a trigger source, see “Trigger Sources” in the *Keysight U2300A Series USB Multifunction Data Acquisition Devices User’s Guide*.

OUTPut:TRIGger:SOURce?

This query returns a string value that represents the trigger source selected for output operations.

Supported models

U2351A, U2353A, U2355A, U2356A, U2331A

Parameter

Item	Type	Range of values	Default value
mode	Discrete	NONE EXTD EXTA STRG	NONE

Example

This example illustrates how the **OUTPut:TRIGger:SOURce** command is used to select the EXTD_AO_TRIG pin as the output trigger source.

- **ROUT:ENAB ON, (@201)** *This command enables channel 201 for output operations.*
- **APPL:SIN 5,0, (@201)** *This command sends a sinusoidal waveform to channel 201 with an amplitude of 5 V (10 V_{pp}) and a DC offset of 0 V.*
- **OUTP:TRIG:SOUR EXTD** *This command sets the EXTD_AO_TRIG pin as the output triggering source.*
- **OUTP:TRIG:DTRG:POL POS** *This command sets a positive-edge trigger condition for the digital trigger source.*
- **OUTP:TRIG:TYP POST** *This command sets a post-trigger acquisition for the analog output.*
- **OUTP ON** *This command generates the sinusoidal waveform from channel 201 when a positive-edge digital signal is received from the EXTD_AO_TRIG pin.*

OUTPut:TRIGger:TYPe

Syntax

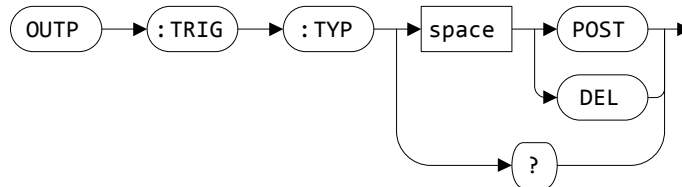

OUTPut:TRIGger:TYPe <mode>

This command is used to set the trigger type for output operations.

The valid options are:

- POST (Post-trigger): The instrument output is generated immediately after the trigger condition is met.
- DEL (Delay-trigger): The instrument output is generated when the delay count reaches zero. The delay count starts immediately after the trigger condition is met.

NOTE

- See “**OUTPut:TRIGger:DCouNT**” on page 97 for more information on how to set a delay counter value.
- For more information on selecting a trigger type, see “Trigger types” in the *Keysight U2300A Series USB Multifunction Data Acquisition Devices User’s Guide*.

OUTPut:TRIGger:TYPe?

This query returns a string value that represents the trigger type selected for output operations.

Supported models

U2351A, U2353A, U2355A, U2356A, U2331A

Parameter

Item	Type	Range of values	Default value
mode	Discrete	POST DEL	POST

See also

“OUTPut:TRIGger:DCouNT” on page 97

Example

This example illustrates how the **OUTPut:TRIGger:TYPE** command is used to select a delay-trigger acquisition as the output trigger type.

- **ROUT:ENAB ON, (@201)** *This command enables channel 201 for output operations.*
- **APPL:SIN 5,0, (@201)** *This command sends a sinusoidal waveform to channel 201 with an amplitude of 5 V (10 V_{pp}) and a DC offset of 0 V.*
- **OUTP:TRIG:SOUR EXT** *This command sets the EXT_{AO}_TRIG pin as the output triggering source.*
- **OUTP:TRIG:DTRG:POL POS** *This command sets a positive-edge trigger condition for the digital trigger source.*
- **OUTP:TRIG:TYP DEL** *This command sets a delay-trigger acquisition for the analog output.*
- **OUTP:TRIG:DCNT
240000000** *This command sets the delay-trigger acquisition counter value.*
- **OUTP ON** *This command generates the sinusoidal waveform from channel 201 once the delay count reaches zero. The delay count starts when a positive-edge digital signal is received from the EXT_{AO}_TRIG pin.*

OUTPut:TRIGger:DCouNT

Syntax

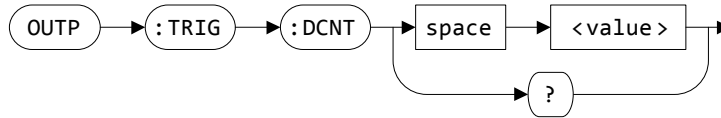

OUTPut:TRIGger:DCouNT <value>

This command is used to set the delay count value. When the count reaches zero, the counter stops and the DAQ device starts generating the instrument output. The count set in the **<value>** parameter will be used when the output trigger type is set to **DEL** (delay-trigger). Set the clock source using the **CONFigure:TIMEbase:SOURce** command.

NOTE

- See **“OUTPut:TRIGger:TYPe”** on page 95 for more information on selecting an output trigger type.
- See **“CONFigure:TIMEbase:SOURce”** on page 58 for more information on selecting a timebase/clock source.

OUTPut:TRIGger:DCouNT?

This query returns a numeric value that represents the delay count value.

Supported models

U2351A, U2353A, U2355A, U2356A, U2331A

Parameter

Item	Type	Range of values	Default value
value	Numeric	0 to 2147483647 (31-bits) ^[a]	0

[a] The delay count parameter is subjected to the following constraints:
 Delay count ≥ 0
 Delay count < 0x7fffffff

See also

“CONFigure:TIMEbase:SOURce” on page 58

“OUTPut:TRIGger:TYPe” on page 95

Example

This example illustrates how the **OUTPut:TRIGger:DCouNT** command is used to set a delay counter value of 240000000. This will set a delay time of 5 seconds (240000000/48 MHz).

→ ROUT:ENAB ON, (@201)	<i>This command enables channel 201 for output operations.</i>
→ APPL:SIN 5,0, (@201)	<i>This command sends a sinusoidal waveform to channel 201 with an amplitude of 5 V (10 V_{pp}) and a DC offset of 0 V.</i>
→ OUTP:TRIG:SOUR EXT	<i>This command sets the EXT_D_AO_TRIG pin as the output triggering source.</i>
→ OUTP:TRIG:DTRG:POL POS	<i>This command sets a positive-edge trigger condition for the digital trigger source.</i>
→ OUTP:TRIG:TYP DEL	<i>This command sets a delay-trigger acquisition for the analog output.</i>
→ OUTP:TRIG:DCNT 240000000	<i>This command sets the delay-trigger acquisition counter value. This implies that channel 201 will generate the sinusoidal waveform 5 seconds (240000000 / 48 MHz) after the trigger condition occurs.</i>
→ OUTP ON	<i>This command generates the sinusoidal waveform from channel 201 5 seconds after a positive-edge digital signal is received from the EXT_D_AO_TRIG pin.</i>

OUTPut:TRIGger:ATRIgger:SOURce

Syntax

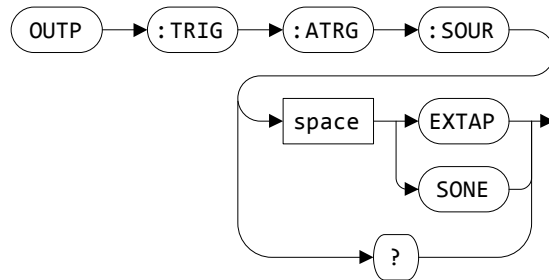

OUTPut:TRIGger:ATRIgger:SOURce <mode>

This command is used to set the analog trigger source for the AO trigger control.

The valid options are:

- EXTAP: Selects the external analog trigger (EXTA_TRIG) pin as the analog triggering source.
- SONE: Selects the first scanned channel of the multiplexing DAQ device as the analog triggering source. The first channel in the instrument scan list will be set as the analog trigger source.

NOTE

- This is an adjunct command for the **OUTPut:TRIGger:SOURce** EXTAP command.
- Use the **ROUTE:SCAN** command to determine the first channel in the instrument scan list.

OUTPut:TRIGger:ATRIgger:SOURce?

This query returns a string value that represents the analog trigger source selected for the AO trigger control.

Supported models

U2351A, U2353A, U2355A, U2356A, U2331A

Parameter

Item	Type	Range of values	Default value
mode	Discrete	EXTAP SONE	EXTAP

See also

[“OUTPut:TRIGger:SOURce”](#) on page 93

[“OUTPut:TRIGger:ATRiGger:CONDition”](#) on page 102

[“OUTPut:TRIGger:ATRiGger:HTHReshold”](#) on page 105

[“OUTPut:TRIGger:ATRiGger:LTHReshold”](#) on page 107

[“ROUTe:SCAN”](#) on page 112

Example

This example illustrates how the **OUTPut:TRIGger:ATriGger:SOURce** command is used to select the first scanned channel of the multiplexing DAQ device as the analog output trigger source.

→ ROUT:ENAB ON, (@201)	<i>This command enables channel 201 for output operations.</i>
→ ROUT:SCAN (@133)	<i>This command sets the instrument to monitor channel 133.</i>
→ APPL:SIN 5,0, (@201)	<i>This command sends a sinusoidal waveform to channel 201 with an amplitude of 5 V (10 V_{pp}) and a DC offset of 0 V.</i>
→ OUTP:TRIG:SOUR EXTA	<i>This command sets the external analog trigger as the output triggering source.</i>
→ OUTP:TRIG:ATRG:SOUR SONE	<i>This command sets the first scanned channel in the instrument scan list as the analog trigger control source.</i>
→ OUTP:TRIG:ATRG:COND BLOW	<i>This command sets a below-low-level triggering condition.</i>
→ OUTP:TRIG:ATRG:LTHR 5	<i>This command sets a 5 V low-threshold.</i>
→ OUTP:TRIG:TYP POST	<i>This command set a post-trigger acquisition for the analog output.</i>
→ RUN	<i>This command starts the continuous data acquisition process.</i>
→ OUTP ON	<i>This command generates the sinusoidal waveform from channel 201 when all trigger conditions are met. If the input signal from channel 133 falls below 5 V, the analog output will be triggered.</i>

OUTPut:TRIGger:ATRIgger:CONDition

Syntax

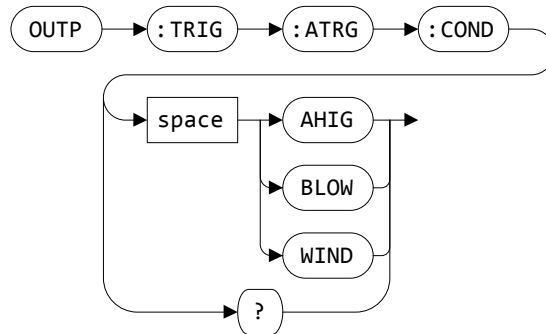

OUTPut:TRIGger:ATRIgger:CONDition <mode>

This command is used to set the trigger condition for the AO trigger control.

The valid options are:

- AHIG (Above-High-Level triggering): The trigger signal is generated when the analog signal is higher than the high-threshold voltage.
- BLOW (Below-Low-Level triggering): The trigger signal is generated when the analog signal is lower than the low-threshold voltage.
- WIND (Window (inside region) triggering): The trigger signal is generated when the analog signal falls within the range of the high-threshold and low-threshold voltages.

NOTE

Use the **OUTPut:TRIGger:ATRIgger:LTHReshold** and **OUTPut:TRIGger:ATRIgger:HTHReshold** commands to set the low-threshold and high-threshold voltages.

OUTPut:TRIGger:ATRIgger:CONDition?

This query returns a string value that represents the trigger condition for the AO trigger control.

Supported models

U2351A, U2353A, U2355A, U2356A, U2331A

Parameter

Item	Type	Range of values	Default value
mode	Discrete	AHIG BLOW WIND	BLOW

See also

[“OUTPut:TRIGger:SOURce”](#) on page 93

[“OUTPut:TRIGger:ATRIgger:SOURce”](#) on page 99

[“OUTPut:TRIGger:ATRIgger:HTHReshold”](#) on page 105

[“OUTPut:TRIGger:ATRIgger:LTHReshold”](#) on page 107

Example

This example illustrates how the **OUTPUT:TRIGGER:ATRIGGER:CONDITION** command is used to select a window triggering condition for the AO trigger control.

→ ROUT:ENAB ON, (@201)	<i>This command enables channel 201 for output operations.</i>
→ APPL:SIN 5,0, (@201)	<i>This command sends a sinusoidal waveform to channel 201 with an amplitude of 5 V (10 V_{pp}) and a DC offset of 0 V.</i>
→ OUTPUT:TRIG:SOUR EXTA	<i>This command sets the external analog trigger as the output triggering source.</i>
→ OUTPUT:TRIG:ATRIG:SOUR EXTAP	<i>This command sets the EXTA_TRIG pin as the analog trigger control source.</i>
→ OUTPUT:TRIG:ATRIG:COND WIND	<i>This command sets a window triggering condition.</i>
→ OUTPUT:TRIG:ATRIG:HTHR 5	<i>This command sets a 5 V high-threshold.</i>
→ OUTPUT:TRIG:ATRIG:LTHR 1	<i>This command sets a 1 V low-threshold.</i>
→ OUTPUT:TRIG:TYP POST	<i>This command set a post-trigger acquisition for the analog output.</i>
→ OUTPUT ON	<i>This command generates the sinusoidal waveform from channel 201 when all trigger conditions are met. If the input signal from the EXTA_TRIG pin falls between 5 V and 1 V, the analog output will be triggered.</i>

OUTPut:TRIGger:ATRIgger:HTHReshold

Syntax

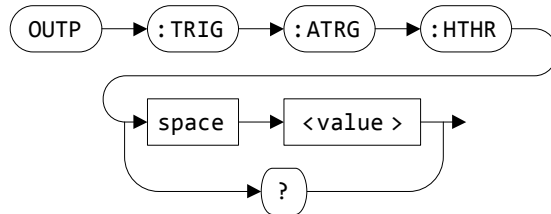

OUTPut:TRIGger:ATRIgger:HTHReshold <value>

This command sets the high-threshold voltage of the AO trigger control.

OUTPut:TRIGger:ATRIgger:HTHReshold?

This query returns a numeric value that represents the high-threshold voltage for the AO trigger control.

Supported models

U2351A, U2353A, U2355A, U2356A, U2331A

Parameter

Item	Type	Range of values	Default value
value	Numeric	-10 V to 10 V	0 V

Remarks

- If **SONE** mode is selected by the **OUTPut:TRIGger:ATRIgger:SOURce** command, the threshold will be limited by the input range configuration of the first channel in the scan list. See **“ROUTe:CHANnel:RANGe”** on page 114 for more information on setting the AI channel input range.
- The high-threshold voltage value must be larger than the low-threshold value.

See also

“OUTPut:TRIGger:SOURce” on page 93

“OUTPut:TRIGger:ATRIgger:SOURce” on page 99

“OUTPut:TRIGger:ATRIgger:CONDition” on page 102

“OUTPut:TRIGger:ATRIgger:LTHReshold” on page 107

Example

This example illustrates how the **OUTPut:TRIGger:ATRIgger:HTHReshold** command is used to set a 5 V high-threshold for the AO trigger control.

→ ROUT:ENAB ON, (@201)	<i>This command enables channel 201 for output operations.</i>
→ APPL:SIN 5,0, (@201)	<i>This command sends a sinusoidal waveform to channel 201 with an amplitude of 5 V (10 V_{pp}) and a DC offset of 0 V.</i>
→ OUTP:TRIG:SOUR EXTA	<i>This command sets the external analog trigger as the output triggering source.</i>
→ OUTP:TRIG:ATRG:SOUR EXTAP	<i>This command sets the EXTA_TRIG pin as the analog trigger control source.</i>
→ OUTP:TRIG:ATRG:COND AHIG	<i>This command sets a above-high-level triggering condition.</i>
→ OUTP:TRIG:ATRG:HTHR 5	<i>This command sets a 5 V high-threshold.</i>
→ OUTP:TRIG:TYP POST	<i>This command set a post-trigger acquisition for the analog output.</i>
→ OUTP ON	<i>This command generates the sinusoidal waveform from channel 201 when all trigger conditions are met. If the input signal rises above 5 V, the analog output will be triggered.</i>

OUTPut:TRIGger:ATriGger:LTHReshold

Syntax

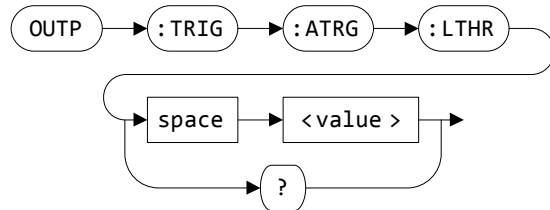

OUTPut:TRIGger:ATriGger:LTHReshold <value>

This command is used to set the low-threshold voltage of the AO trigger control.

OUTPut:TRIGger:ATriGger:LTHReshold?

This query returns a numeric value that represents the low-threshold voltage for the AO trigger control.

Supported models

U2351A, U2353A, U2355A, U2356A, U2331A

Parameter

Item	Type	Range of values	Default value
value	Numeric	-10 V to 10 V	0 V

Remarks

- If **SONE** mode is selected by the **OUTPut:TRIGger:ATriGger:SOURce** command, the threshold will be limited by the input range configuration of the first channel in the scan list. See **“ROUTe:CHANnel:RANGe”** on page 114 for more information on setting the AI channel input range.
- The high-threshold voltage value must be larger than the low-threshold value.

See also

“OUTPut:TRIGger:SOURce” on page 93

“OUTPut:TRIGger:ATRIgger:SOURce” on page 99

“OUTPut:TRIGger:ATRIgger:CONDition” on page 102

“OUTPut:TRIGger:ATRIgger:HTHReshold” on page 105

Example

This example illustrates how the **OUTPut:TRIGger:ATRIgger:LTHReshold** command is used to set a 1 V low-threshold for the AO trigger control.

→ ROUT:ENAB ON, (@201)	<i>This command enables channel 201 for output operations.</i>
→ APPL:SIN 5,0, (@201)	<i>This command sends a sinusoidal waveform to channel 201 with an amplitude of 5 V (10 V_{pp}) and a DC offset of 0 V.</i>
→ OUTP:TRIG:SOUR EXTA	<i>This command sets the external analog trigger as the output triggering source.</i>
→ OUTP:TRIG:ATRG:SOUR EXTAP	<i>This command sets the EXTA_TRIG pin as the analog trigger control source.</i>
→ OUTP:TRIG:ATRG:COND BLOW	<i>This command sets a below-low-level triggering condition.</i>
→ OUTP:TRIG:ATRG:LTHR 1	<i>This command sets a 1 V low-threshold.</i>
→ OUTP:TRIG:TYP POST	<i>This command set a post-trigger acquisition for the analog output.</i>
→ OUTP ON	<i>This command generates the sinusoidal waveform from channel 201 when all trigger conditions are met. If the input signal falls below 1 V, the analog output will be triggered.</i>

OUTPut:TRIGger:DTRiGger:POLarity

Syntax

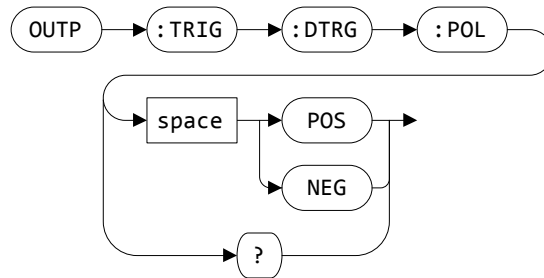

OUTPut:TRIGger:DTRiGger:POLarity <mode>

This command is used to set the polarity of the DIO trigger control.

The valid options are:

- POS (Positive-edge triggering): The trigger signal is generated when a rising edge is detected in the digital signal.
- NEG (Negative-edge triggering): The trigger signal is generated when a falling edge is detected in the digital signal.

OUTPut:TRIGger:DTRiGger:POLarity?

This query returns a string value that represents the polarity selected for the DIO trigger control.

Supported models

U2351A, U2353A, U2355A, U2356A, U2331A

Parameter

Item	Type	Range of values	Default value
mode	Discrete	POS NEG	POS

See also

“OUTPut:TRIGger:SOURce” on page 93

“OUTPut:TRIGger:TYPe” on page 95

Example

This example illustrates how the **OUTPut:TRIGger:DTRiGger:POLarity** command is used to select a negative-edge trigger condition for the DIO trigger control.

- **ROUT:ENAB ON, (@201)** *This command enables channel 201 for output operations.*
- **APPL:SIN 5,0, (@201)** *This command sends a sinusoidal waveform to channel 201 with an amplitude of 5 V (10 V_{pp}) and a DC offset of 0 V.*
- **OUTP:TRIG:SOUR EXTD** *This command sets the EXTD_AO_TRIG pin as the output triggering source.*
- **OUTP:TRIG:DTRG:POL NEG** *This command sets a negative-edge trigger condition for the digital trigger source.*
- **OUTP:TRIG:TYP POST** *This command set a post-trigger acquisition for the analog output.*
- **OUTP ON** *This command generates the sinusoidal waveform from channel 201 when a negative-edge digital signal is received from the EXTD_AO_TRIG pin.*

8 ROUTe Subsystem

ROUTe:SCAN	112
ROUTe:CHANnel:RANGe	114
ROUTe:CHANnel:POLarity	116
ROUTe:CHANnel:STYPe	118
ROUTe:CHANnel:RSouRCe	120
ROUTe:CHANnel:RVOLTage	122
ROUTe:ENABLe	124

This chapter describes the ROUTe commands used to program the U2300A Series DAQ device over a remote interface. Use the ROUTe:SCAN command to set up a scan list that includes all desired AI channels. You can also configure the AI/AO channels range, polarity, input signal type, and reference voltage source.

ROUTe:SCAN

Syntax

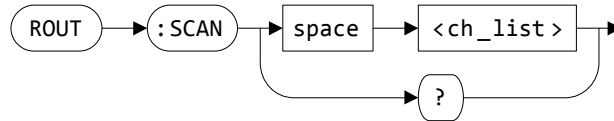

ROUTe:SCAN <ch_list>

This command is used to set up an input channel acquisition sequence. This acquisition sequence is also known as a scan list. You should set up the scan list to include all desired AI channels.

ROUTe:SCAN?

This query returns a numeric value that represents all the AI channel(s) included in the scan list. Multiple responses are separated by commas.

Supported models

U2351A, U2352A, U2353A, U2354A, U2355A, U2356A, U2331A

Parameter

Item	Type	Range of values	Default value
ch_list	Channel list	Single-ended mode: - U2351A/52A/53A/54A: (@101) to (@116) - U2355A/56A/31A: (@101) to (@164) Differential mode: - U2351A/52A/53A/54A: (@101) to (@108) - U2355A/56A/31A: (@101) to (@132)	(@101)

Remarks

- The maximum number of entries in the `<ch_list>` parameter is 100.
- Repeated channel assignment in the scan list is allowed, for example 101, 102, 103, 101, 102, and so on. Consecutive channels can be specified using a colon or comma, for example 101, 102, 103, or 101:103.
- This command is capable of changing the scan order without changing the channel range (`ROUTE:CHANnel:RANGe`), polarity (`ROUTE:CHANnel:POLarity`), or input signal type (`ROUTE:CHANnel:STYPe`).

See also

[“ROUTE:CHANnel:RANGe”](#) on page 114

[“ROUTE:CHANnel:POLarity”](#) on page 116

[“ROUTE:CHANnel:STYPe”](#) on page 118

Example

This example illustrates how the `ROUTE:SCAN` command is used to set up the instrument scan list.

→ <code>ROUTE:SCAN (@101:112)</code>	<i>This command sets up the scan list to include channel 101 to channel 112.</i>
→ <code>ROUTE:SCAN?</code>	<i>This query returns all the channels included in the instrument scan list.</i>
← <code>101,102,103,104,105, 106,107,108,109,110, 111,112</code>	<i>12 entries are returned.</i>
→ <code>ROUTE:SCAN (@101:103,101:103, 101:103)</code>	<i>This command sets up the scan list to repeat channel 101 to channel 103 thrice.</i>
→ <code>ROUTE:SCAN?</code>	
← <code>101,102,103,101,102, 103,101,102,103</code>	<i>9 entries are returned.</i>

ROUTe:CHANnel:RANGe

Syntax

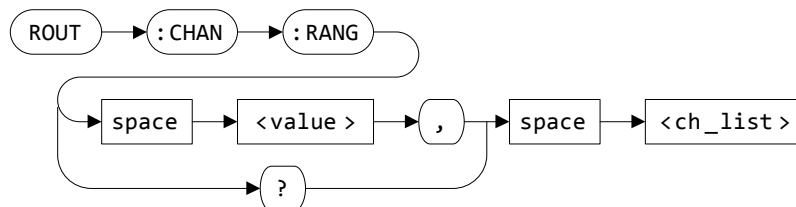

ROUTe:CHANnel:RANGe <value>, <ch_list>

This command is used to set the range for the AI channel(s) specified in the <ch_list> parameter.

ROUTe:CHANnel:RANGe? <ch_list>

This query returns a numeric value that represents the range of each AI channel specified. Multiple responses are separated by commas. The value returned is expressed in volts (V).

Supported models

U2351A, U2352A, U2353A, U2354A, U2355A, U2356A, U2331A

Parameter

Item	Type	Range of values	Default value
value	Discrete	U2331A: - Unipolar mode: {10 5 4 2.5 2.0 1.0 0.5 0.4 0.1} - Bipolar mode: {10 5 2.5 2.0 1.25 1.0 0.5 0.25 0.2 0.05} U2351A/52A/53A/54A/55A/56A: - Unipolar/Bipolar mode: {10 5 2.5 1.25}	10 V
ch_list	Channel list	Single-ended mode: - U2351A/52A/53A/54A: (@101) to (@116) - U2355A/56A/31A: (@101) to (@164) Differential mode: - U2351A/52A/53A/54A: (@101) to (@108) - U2355A/56A/31A: (@101) to (@132)	-

Remarks

If the AI channel polarity is set to unipolar, setting a value of 10 in the **<value>** parameter will result in a range from 0 V to +10 V. Whereas, if the AI channel polarity is set to bipolar, setting a value of 10 in the **<value>** parameter will result in a range from -10 V to +10 V.

NOTE

For more information on selecting the AI channel polarity, see **“ROUTe:CHANnel:POLarity”** on page 116.

See also

“ROUTe:CHANnel:POLarity” on page 116

Example

This example illustrates how the **ROUTe:CHANnel:RANGe** command is used to specify the range of AI channel 101.

→ ROUT:CHAN:POL BIP, (@101)	<i>This command sets the polarity of channel 101 to bipolar.</i>
→ ROUT:CHAN:RANG 5, (@101)	<i>This command sets channel 101 to expect input signals from a range of -5 V to +5 V.</i>
→ ROUT:CHAN:POL UNIP, (@101)	<i>This command sets the polarity of channel 101 to unipolar.</i>
→ ROUT:CHAN:RANG 5, (@101)	<i>This command sets channel 101 to expect input signals from a range of 0 V to +5 V.</i>

ROUTe:CHANnel:POLarity

Syntax

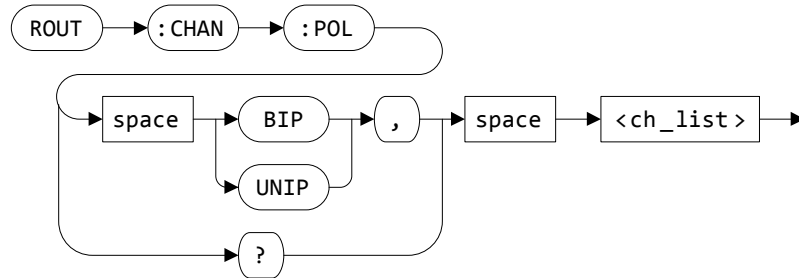

ROUTe:CHANnel:POLarity <mode>, <ch_list>

This command is used to set the polarity of the AI or AO channel(s) specified in the <ch_list> parameter.

The valid options are:

- BIPolar
- UNIPolar

ROUTe:CHANnel:POLarity? <ch_list>

This query returns a string value that represents the polarity of each AI or AO channel specified. Multiple responses are separated by commas.

Supported models

U2351A, U2352A, U2353A, U2354A, U2355A, U2356A, U2331A

Parameter

Item	Type	Range of values	Default value
mode	Discrete	UNIPolar BIPolar	BIPolar
ch_list	Channel list	Single-ended mode: - U2351A/52A/53A/54A: (@101) to (@116) (@201) to (@202) - U2355A/56A/31A: (@101) to (@164) (@201) to (@202) Differential mode: - U2351A/52A/53A/54A: (@101) to (@108) (@201) to (@202) - U2355A/56A/31A: (@101) to (@132) (@201) to (@202)	-

Example

This example illustrates how the **ROUTe:CHANnel:POLarity** command is used to change the polarity of AI channel 101.

```

→ ROUT:CHAN:POL?
  (@101:103)
    This query returns the polarity of channel 101
    to 103.

← BIP,BIP,BIP
    The returned value "BIP" for all channels
    indicates the instrument default polarity –
    bipolar.

→ ROUT:CHAN:POL UNIP,
  (@101)
    This command changes the polarity of
    channel 101 to unipolar.

→ ROUT:CHAN:POL?
  (@101:103)

← UNIP,BIP,BIP
    The returned value "UNIP" for channel 101
    indicates a change in the polarity of
    channel 101.
  
```

ROUTe:CHANnel:STYPe

Syntax

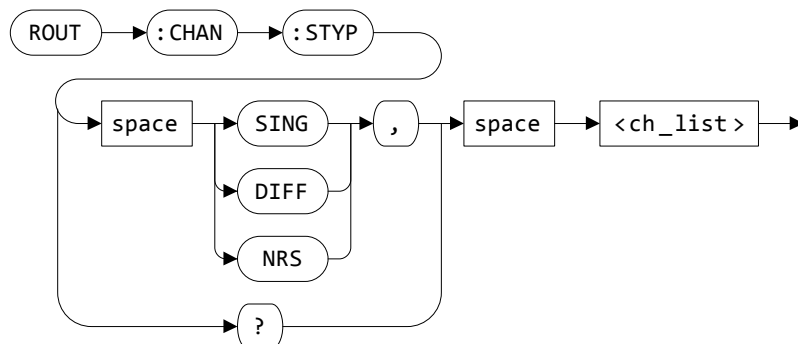

ROUTe:CHANnel:STYPe <mode>, <ch_list>

This command is used to set the input signal type (reference ground selection) for the AI channel(s) specified in the <ch_list> parameter.

The valid options are:

- SING: Referenced single-ended mode; 16 or 64 channels common to the ground system (AI_GND pin) on board.
- DIFF: Differential mode.
- NRS: Non-referenced single-ended mode; 16 or 64 channels common to the AI_SENSE pin.

NOTE

For more information on the various types of analog input configurations, see “Analog Input Signal Connection” in the *Keysight U2300A Series USB Multifunction Data Acquisition Devices User’s Guide*.

ROUTe:CHANnel:STYPe? <ch_list>

This query returns a string value that represents the input signal type of each AI channel specified. Multiple responses are separated by commas.

Supported models

U2351A, U2352A, U2353A, U2354A, U2355A, U2356A, U2331A

Parameter

Item	Type	Range of values	Default value
mode	Discrete	SING DIFF NRS	SING
ch_list	Channel list	Single-ended mode: - U2351A/52A/53A/54A: (@101) to (@116) ^[a] - U2355A/56A/31A: (@101) to (@164) ^[b] Differential mode: - U2351A/52A/53A/54A: (@101) to (@108) - U2355A/56A/31A: (@101) to (@132)	-

[a] Channels 108 to 116 only supports referenced single-ended (SING) and non-referenced single-ended (NRS) modes.

[b] Channels 132 to 164 only supports referenced single-ended (SING) and non-referenced single-ended (NRS) modes.

Example

This example illustrates how the **ROUTe:CHANnel:STYPe** command is used to change the input signal type of AI channel 101.

```

→ ROUT:CHAN:STYP? (@101) This query returns the input signal type for channel 101.

← SING The returned value "SING" indicates the instrument default input signal type – referenced single-ended.

→ ROUT:CHAN:STYP NRS, (@101) This command changes the input signal type of channel 101 to non-referenced single-ended.

→ ROUT:CHAN:STYP? (@101)

← NRS The returned value "NRS" indicates that the input signal type for channel 101 has been changed to a non-referenced single-ended signal type.

```

ROUTe:CHANnel:RSouRCe

Syntax

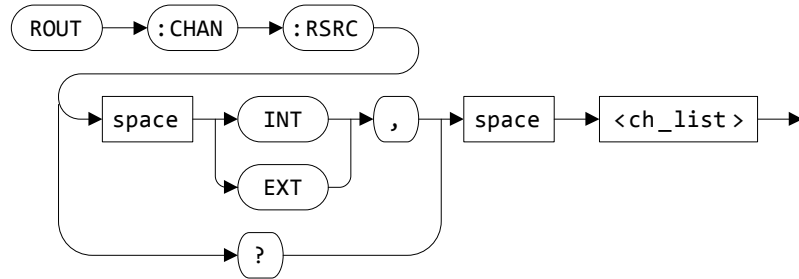

ROUTe:CHANnel:RSouRCe <mode>, <ch_list>

This command is used to set the reference voltage source for the AO channel(s) specified in the <ch_list> parameter.

The valid options are:

- INTernal: Internal on-board reference voltage.
- EXTernal: Selects the AO_EXT_REF pin as the reference voltage source.

NOTE

- The reference voltage coming in from the AO_EXT_REF pin must be set in the DAQ device via the **ROUTe:CHANnel:RVOLtage** command. For example, if a 5 V reference voltage is expected from the AO_EXT_REF pin, you must send the **ROUTe:CHANnel:RVOLtage 5** command to the DAQ device.
- See **“ROUTe:CHANnel:RVOLtage”** on page 122 for more information on how to set the external reference voltage value.

ROUTe:CHANnel:RSouRCe? <ch_list>

This query returns a string value that represents the reference voltage source of each AO channel specified. Multiple responses are separated by commas.

Supported models

U2351A, U2353A, U2355A, U2356A, U2331A

Parameter

Item	Type	Range of values	Default value
mode	Discrete	INTernal EXTernal	INTernal
ch_list	Channel list	- U2351A: (@202) - U2353A/55A/56A/31A: (@201) to (@202)	-

See also

[“ROUTe:CHANnel:RVOLtage”](#) on page 122

Example

This example illustrates how the **ROUTe:CHANne1:RSouRCe** command is used to change the AO channels reference voltage source.

```

→ ROUT:CHAN:RSRC EXT This command sets the instrument reference voltage source to the AO_EXT_REF pin. A 5 V voltage source is then supplied to the AO_EXT_REF pin.

→ ROUT:CHAN:RVOL 5 Since we are expecting a 5 V voltage source from the AO_EXT_REF pin, this command is used to set the external reference voltage to 5 V.

→ ROUT:CHAN:RSRC? This query returns the reference voltage source for the AO channels.

← EXT

```

ROUTe:CHANnel:RVOLtage

Syntax

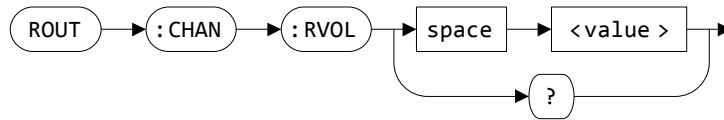

ROUTe:CHANnel:RVOLtage <value>

This command is used to set the external reference voltage value for the AO channels. The reference voltage set in the `<value>` parameter must be the same as the voltage value supplied to the AO_EXT_REF pin when the reference voltage source is set to **EXTernal1**. The reference voltage value is expressed in units of volts (V).

NOTE

See **“ROUTe:CHANnel:RSouRCe”** on page 120 for more information on selecting a reference voltage source.

ROUTe:CHANnel:RVOLtage?

This query returns a string value that represents the external reference voltage value. The value returned is expressed in volts (V).

Supported models

U2351A, U2353A, U2355A, U2356A, U2331A

Parameter

Item	Type	Range of values	Default value
value	Numeric	$0 < \text{value} \leq 10$	10 V

Remarks

The reference voltage value cannot be set to zero or a negative value.

See also

“[ROUTe:CHANnel:RSouRCe](#)” on page 120

Example

This example illustrates how the **ROUTe:CHANnel:RVOLtage** command is used to set the external reference voltage value.

→ **ROUT:CHAN:RSRC EXT** *This command sets the instrument reference voltage source to the AO_EXT_REF pin. A 5 V voltage source is then supplied to the AO_EXT_REF pin.*

→ **ROUT:CHAN:RVOL 5** *Since we are expecting a 5 V voltage source from the AO_EXT_REF pin, this command is used to set the external reference voltage to 5 V.*

→ **ROUT:CHAN:RVOL?** *This query returns the external reference voltage value for the AO channels.*

← 5

ROUTe:ENABle

Syntax

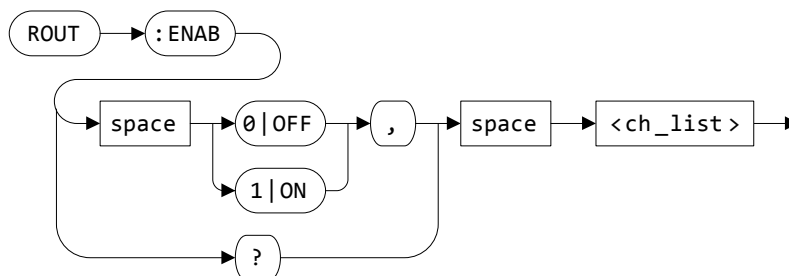

ROUTe:ENABle <mode>, <ch_list>

This command is used to enable or disable the signal route for the AO channel(s) specified in the **<ch_list>** parameter. By enabling a channel, electrical signals are allowed to pass through that enabled channel. Likewise, by disabling a particular channel, electrical signals are not allowed to pass through the said channel.

ROUTe:ENABle? <@ch_list>

This query returns a boolean value that represents the status of each AO channel specified. Multiple responses are separated by commas.

- “0” indicates that the specific channel is disabled, and
- “1” indicates that the specific channel is enabled.

Supported models

U2351A, U2353A, U2355A, U2356A, U2331A

Parameter

Item	Type	Range of values	Default value
mode	Boolean	0 OFF 1 ON	0
ch_list	Channel list	(@201)(@202)	-

Example

This example illustrates how the **ROUTe:ENABle** command is used to enable channel 201 and 202 for AO operations.

- **ROUT:ENAB 1, (@201:202)** *This command enables channel 201 and 202 for analog output operations.*
- **APPL:SIN 5,0, (@201)** *This command sends a sinusoidal waveform with 5 V (10 V_{pp}) and 0 V offset to the instrument buffer.*
- **APPL:SQU 5,0, (@202)** *This command sends a square waveform with 5 V (10 V_{pp}) and 0 V offset to the instrument buffer.*
- **OUTP ON** *This command outputs a sinusoidal waveform from channel 201 and a square waveform from channel 202.*

THIS PAGE HAS BEEN INTENTIONALLY LEFT BLANK.

9 SENSE Subsystem

[SENSe:]VOLTage:RANGe	128
[SENSe:]VOLTage:POLarity	131
[SENSe:]VOLTage:STYPe	133
[SENSe:]COUNter:FUNctIon	136
[SENSe:]COUNter:ABORT	138
[SENSe:]COUNter:GATE:SOURce	140
[SENSe:]COUNter:GATE:POLarity	142
[SENSe:]COUNter:GATE:CONTRol	144
[SENSe:]COUNter:CLock:SOURce	146
[SENSe:]COUNter:CLock:INTernal?	148
[SENSe:]COUNter:CLock:EXTernal	149
[SENSe:]COUNter:CLock:POLarity	151
[SENSe:]COUNter:TOTALize:IVALue	153
[SENSe:]COUNter:TOTALize:INITiate	155
[SENSe:]COUNter:TOTALize:CLEar	156
[SENSe:]COUNter:TOTALize:UDOWn:SOURce	158
[SENSe:]COUNter:TOTALize:UDOWn:DIRectIon	160

This chapter describes the SENSE commands used to program the U2300A Series DAQ device over a remote interface. Use the SENSE commands to change the AI channels settings prior to making a single voltage measurement. You can also select a counter function and configure its properties.

[SENSe:]VOLTage:RANGe

Syntax

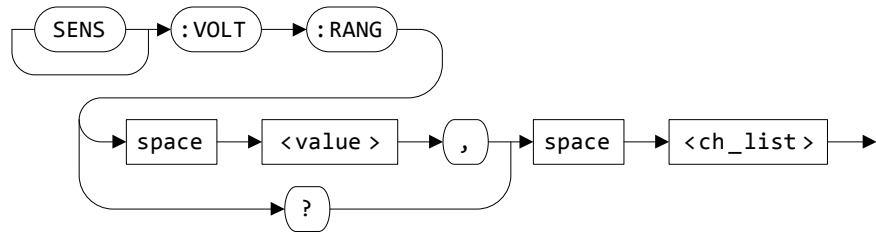

[SENSe:]VOLTage:RANGe <value>, <ch_list>

This command is used to set the range for the AI channel(s) specified in the <ch_list> parameter. This command is applicable for polling mode operations.

[SENSe:]VOLTage:RANGe? <ch_list>

This query returns a numeric value that represents the voltage range of each AI channel specified. Multiple responses are separated by commas. The value returned is expressed in volts (V).

Supported models

U2351A, U2352A, U2353A, U2354A, U2355A, U2356A, U2331A

Parameter

Item	Type	Range of values	Default value
value	Discrete	U2331A: – Unipolar mode: {AUTO 10 5 4 2.5 2.0 1.0 0.5 0.4 0.1} – Bipolar mode: {AUTO 10 5 2.5 2.0 1.25 1.0 0.5 0.25 0.2 0.05} U2351A/52A/53A/54A/55A/56A: – Unipolar/Bipolar mode: {AUTO 10 5 2.5 1.25}	AUTO
ch_list	Channel list	Single-ended mode: – U2351A/52A/53A/54A: (@101) to (@116) – U2355A/56A/31A: (@101) to (@164) Differential mode: – U2351A/52A/53A/54A: (@101) to (@108) – U2355A/56A/31A: (@101) to (@132)	-

Remarks

If the input voltage polarity is set to unipolar, setting a value of 10 in the **<value>** parameter will result in a range from 0 V to +10 V. Whereas, if the input voltage polarity is set to bipolar, setting a value of 10 in the **<value>** parameter will result in a range from –10 V to +10 V.

See also

[“MEASure\[:VOLTage\]\[:DC\]?”](#) on page 66

[“\[SENSe:\]VOLTage:POLarity”](#) on page 131

[“\[SENSe:\]VOLTage:STYPe”](#) on page 133

Example

This example illustrates how the **MEASure[:VOLTage][:DC]?** query is used to make a single voltage measurement from AI channel 101. The **[SENSe:]VOLTage:RANGe** command is used to change the input range of AI channel 101.

- **VOLT:POL BIP, (@101)** *This command changes the polarity of channel 101 to bipolar.*
- **VOLT:STYP SING, (@101)** *This command changes the input signal type of channel 101 to referenced single-ended.*
- **VOLT:RANG 5, (@101)** *This command sets channel 101 to expect an input voltage within a range of -5 V to +5 V.*
- **MEAS? (@101)** *This query returns a single voltage measurement from channel 101.*
- ← **4.102**

[SENSe:]VOLTage:POLarity

Syntax

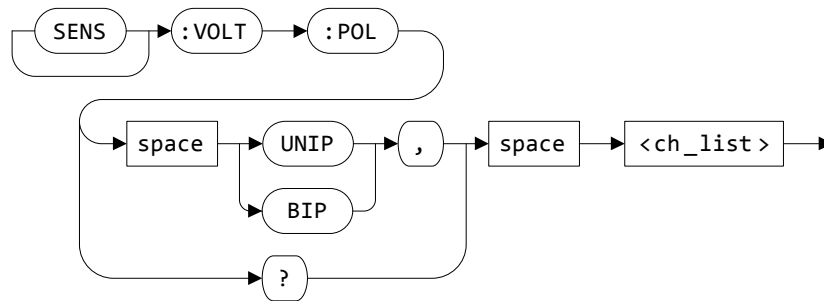

[SENSe:]VOLTage:POLarity <mode>, <ch_list>

This command is used to set the polarity of the AI channel(s) specified in the <ch_list> parameter. This command is applicable for polling mode operations.

The valid options are:

- BIPolar
- UNIPolar

[SENSe]:VOLTage:POLarity? <ch_list>

This query returns a string value that represents the polarity of each AI channel specified. Multiple responses are separated by commas.

Supported models

U2351A, U2352A, U2353A, U2354A, U2355A, U2356A, U2331A

Parameter

Item	Type	Range of values	Default value
mode	Discrete	UNIPolar BIPolar	BIPolar
ch_list	Channel list	Single-ended mode: - U2351A/52A/53A/54A: (@101) to (@116) - U2355A/56A/31A: (@101) to (@164) Differential mode: - U2351A/52A/53A/54A: (@101) to (@108) - U2355A/56A/31A: (@101) to (@132)	-

See also

“MEASure[:VOLTage][:DC]?” on page 66

“[SENSe:]VOLTage:RANGe” on page 128

“[SENSe:]VOLTage:STYPe” on page 133

Example

This example illustrates how the **MEASure[:VOLTage][:DC]?** query is used to make a single voltage measurement from AI channel 101. The **[SENSe:]VOLTage:POLarity** command is used to change the polarity of AI channel 101.

→ VOLT:POL UNIP, (@101)	<i>This command changes the polarity of channel 101 to unipolar.</i>
→ VOLT:STYP SING, (@101)	<i>This command changes the input signal type of channel 101 to referenced single-ended.</i>
→ VOLT:RANG 5, (@101)	<i>This command sets channel 101 to expect an input voltage within a range of 0 V to +5 V.</i>
→ MEAS? (@101)	<i>This query returns a single voltage measurement from channel 101.</i>
← 4.102	

[SENSe:]VOLTage:STYPe

Syntax

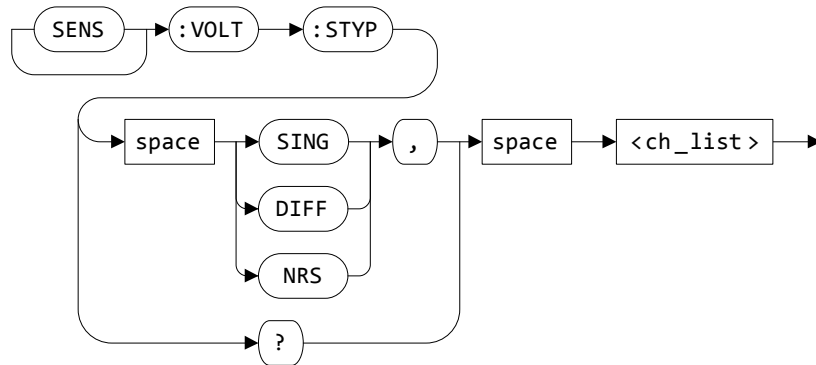

[SENSe]:VOLTage:STYPe <mode>, <ch_list>

This command is used to set the input signal type (reference ground selection) for the AI channel(s) specified in the <ch_list> parameter. This command is applicable for polling mode operations.

The valid options are:

- SING: Referenced single-ended mode; 16 or 64 channels common to the ground system (AI_GND pin) on board.
- DIFF: Differential mode.
- NRS: Non-referenced single-ended mode; 16 or 64 channels common to the AI_SENSE pin.

NOTE

For more information on the various types of analog input configurations, see “Analog Input Signal Connection” in the *Keysight U2300A Series USB Multifunction Data Acquisition Devices User’s Guide*.

[SENSe]:VOLTage:STYPe? <ch_list>

This query returns a string value that represents the input signal type of each AI channel specified. Multiple responses are separated by commas.

Supported models

U2351A, U2352A, U2353A, U2354A, U2355A, U2356A, U2331A

Parameter

Item	Type	Range of values	Default value
mode	Discrete	SING DIFF NRS	SING
ch_list	Channel list	Single-ended mode: - U2351A/52A/53A/54A: (@101) to (@116) ^[a] - U2355A/56A/31A: (@101) to (@164) ^[b] Differential mode: - U2351A/52A/53A/54A: (@101) to (@108) - U2355A/56A/31A: (@101) to (@132)	-

[a] Channels 108 to 116 only supports referenced single-ended (SING) and non-referenced single-ended (NRS) modes.

[b] Channels 132 to 164 only supports referenced single-ended (SING) and non-referenced single-ended (NRS) modes.

Remarks

- For the U2355A, U2356A, and U2331A; if channel 101 is configured to the differential mode, channel 133 will be unavailable until channel 101 is set back to the referenced single-ended mode again. Likewise, if channel 102 is configured to the differential mode, channel 134 will be unavailable until channel 102 is set back to the referenced single-ended mode again.
- For the U2351A, U2352A, U2353A and U2354A; if channel 101 is configured to the differential mode, channel 109 will be unavailable until channel 101 is set back to the referenced single-ended mode again. Likewise, if channel 102 is configured to the differential mode, channel 110 will be unavailable until channel 102 is set back to the referenced single-ended mode again.

NOTE

For more information on the U2300A Series DAQ device pins configuration, see Chapter 2, “Connector Pins Configuration” in the *Keysight U2300A Series USB Multifunction Data Acquisition Devices User’s Guide*.

See also

“MEASure[:VOLTage][:DC]?” on page 66

“[SENSe:]VOLTage:RANGe” on page 128

“[SENSe:]VOLTage:POLarity” on page 131

Example

This example illustrates how the **MEASure[:VOLTage][:DC]?** query is used to make a single voltage measurement from AI channel 101. The **[SENSe:]VOLTage:STYPe** command is used to change the input signal type of AI channel 101.

→ **VOLT:POL UNIP, (@101)** *This command changes the polarity of channel 101 to unipolar.*

→ **VOLT:STYP DIFF, (@101)** *This command changes the input signal type of channel 101 to differential.*

→ **VOLT:RANG 5, (@101)** *This command sets channel 101 to expect an input voltage within a range of 0 V to +5 V.*

→ **MEAS? (@101)** *This query returns a single voltage measurement from channel 101.*

← **4.102**

[SENSe:]COUNter:FUNcTion

Syntax

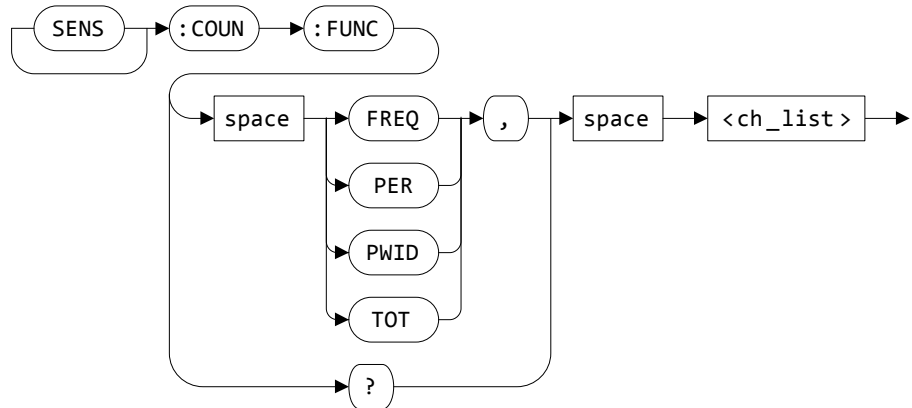

[SENSe:]COUNter:FUNcTion <mode>, <ch_list>

This command is used to select a counter function for the counter channel(s) specified in the <ch_list> parameter.

The valid options are:

- FREQuency: Frequency measurement
- PERiod: Period measurement
- PWIDth: Pulse width measurement
- TOTalize: Totalizer measurement

[SENSe:]COUNter:FUNcTion? <ch_list>

This query returns a string value that represents the current counter function of each counter channel specified. Multiple responses are separated by commas.

Supported models

U2351A, U2352A, U2353A, U2354A, U2355A, U2356A, U2331A

Parameter

Item	Type	Range of values	Default value
mode	Discrete	TOTalize FREQuency PERiod PWIDth	TOTalize
ch_list	Channel list	(@301) (@302)	-

Remarks

This is an adjunct command for the **MEASure:COUNter:DATA?** query.

See also

“**MEASure:COUNter:DATA?**” on page 68

Example

This example illustrates how the **[SENSe:]COUNter:FUNction** command is used to make a single frequency measurement on counter channel 301.

```

→ *CLS; *RST           These commands clears and resets the
                        instrument to its default settings.

→ COUN:FUNC FREQ, (@301) This command sets channel 301 to measure
                        frequency.

→ MEAS:COUN:DATA? (@301) This query returns the frequency for
                        channel 301.

← 5.599627             The frequency value is returned in kHz.

```

[SENSe:]COUNter:ABORt

Syntax



[SENSe:]COUNter:ABORt <ch_list>

This command is used to abort a counter or totalizer measurement in progress for the counter channel(s) specified in the <ch_list> parameter. This command may be effective to abort a long internally-gated or externally-gated measurement.

NOTE

To initiate a totalizer measurement, use the [SENSe:]COUNter:TOTAlize:INITiate command. To make a single counter measurement (frequency, pulse width, or period) use the [SENSe:]COUNter:FUNCTion command together with the MEASure:COUNter:DATA? query.

Supported models

U2351A, U2352A, U2353A, U2354A, U2355A, U2356A, U2331A

Parameter

Item	Type	Range of values	Default value
ch_list	Channel list	(@301)(@302)	-

Remarks

This command does not clear or invalidate any measurement in the instrument memory.

See also

“MEASure:COUNter:DATA?” on page 68

“[SENSe:]COUNter:FUNCTion” on page 136

“[SENSe:]COUNter:TOTAlize:INITiate” on page 155

Example

This example illustrates how the **[SENSe:]COUNter:ABORt** command is used to abort the totalizer measurement running on counter channel 301.

- ***CLS; *RST** *These commands clear and reset the instrument to its default settings.*
- **COUN:FUNC TOT, (@301)** *This command selects the totalizer measurement for channel 301.*
- **COUN:TOT:INIT (@301)** *This command starts the totalizer measurement on channel 301 with the instrument default values.*
- **COUN:GATE:CONT ENAB, (@301)** *This command enables the gate of channel 301. The input signals are now allowed to pass.*
- **MEAS:COUN:DATA? (@301)** *This query returns the totalized value of the input signals.*
- ← **64838** *The totalized value thus far is returned.*
- **COUN:GATE:CONT DIS (@301)** *This command disables the gate of channel 301. The totalizing process is halted.*
- **COUN:ABOR (@301)** *This command aborts the current totalizer measurement in progress.*
- **COUN:GATE:CONT ENAB, (@301)** *This command enables the gate of channel 301. The input signals are now allowed to pass again; the totalizing process is resumed.*
- **MEAS:COUN:DATA? (@301)**
- ← **64838** *The returned value “64838” is the same value as the previous query. This is because the previously initiated totalizer measurement has already been aborted.*

[SENSe:]COUNter:GATE:SOURce

Syntax

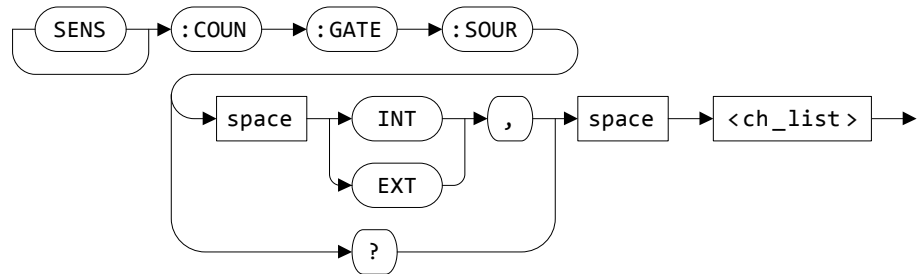

[SENSe:]COUNter:GATE:SOURce <mode>, <ch_list>

This command is used to select a gate source for the counter channel(s) specified in the <ch_list> parameter. Do not change the gate source while an initiated measurement is in progress.

The valid options are:

- INTERNAL: The gate is controlled over a remote interface using SCPI commands.
- EXTERNAL: The gate is controlled by the COUNT301_GATE or COUNT302_GATE pins.

NOTE

For more information on controlling the general purpose digital counter gate over a remote interface, see “[SENSe:]COUNter:GATE:CONTRol” on page 144.

[SENSe:]COUNter:GATE:SOURce? <ch_list>

This query returns a string value that represents the gate source selected for each counter channel specified. Multiple responses are separated by commas.

Supported models

U2351A, U2352A, U2353A, U2354A, U2355A, U2356A, U2331A

Parameter

Item	Type	Range of values	Default value
mode	Discrete	INTernal EXTernal	INTernal
ch_list	Channel list	(@301) (@302)	-

Example

This example illustrates how the **[SENSe:]COUNTER:GATE:SOURce** command is used to change the gate source of counter channel 301.

- **COUN:FUNC TOT,(@301)** *This command selects the totalizer measurement for channel 301.*
- **COUN:GATE:SOUR EXT,(@301)** *This command selects an external gate source for the totalizer measurement on channel 301. This implies that the input signal from the COUNT301_GATE pin will be used to start and stop the counting duration. Supply an input signal through the COUNT301_GATE pin to begin the totalizing process.*
- **COUN:GATE:POL AHI,(@301)** *This command sets an active high logic polarity at the gate input line of channel 301.*
- **COUN:CLK:POL AHI,(@301)** *This command sets an active high clock polarity for the totalizer measurement on channel 301.*
- **COUN:CLK:SOUR INT,(@301)** *This command selects an internal clock source for the totalizer measurement on channel 301.*
- **COUN:TOT:IVAL 0,(@301)** *This command sets an initial counter value of 0.*
- **COUN:TOT:UDOW:DIR UP,(@301)** *This command sets a counting up direction for the totalizer measurement on channel 301.*
- **COUN:TOT:INIT (@301)** *This command starts the totalizer measurement on channel 301.*
- **COUN:GATE:CONT ENAB,(@301)** *This command enables the gate of channel 301. The input signals are now allowed to pass.*

[SENSe:]COUNter:GATE:POLarity

Syntax

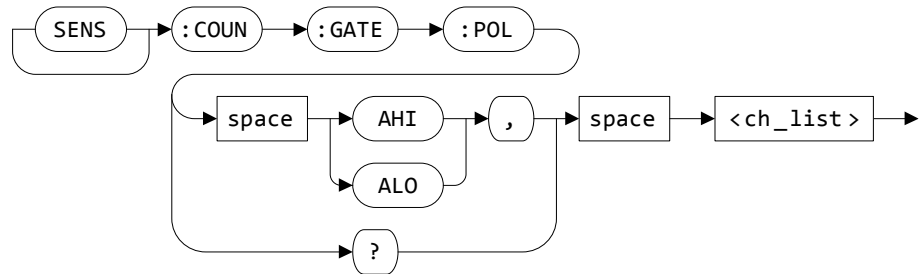

[SENSe:]COUNter:GATE:POLarity <mode>, <ch_list>

This command is used to set the logic polarity of the gate input line for the counter channel(s) specified in the <ch_list> parameter.

The valid options are:

- AHI: Active high polarity
- ALO: Active low polarity

[SENSe:]COUNter:GATE:POLarity? <ch_list>

This query returns a string value that represents the gate polarity of each counter channel specified. Multiple responses are separated by commas.

Supported models

U2351A, U2352A, U2353A, U2354A, U2355A, U2356A, U2331A

Parameter

Item	Type	Range of values	Default value
mode	Discrete	AHI ALO	AHI
ch_list	Channel list	(@301)(@302)	-

Remarks

Changing the gate polarity while an initiated measurement is in progress is not allowed.

Example

This example illustrates how the **[SENSe:]COUNTER:GATE:POLarity** command is used to change the logic polarity of the gate input line on counter channel 301.

- **COUN:FUNC TOT, (@301)** *This command selects the totalizer measurement for channel 301.*
- **COUN:GATE:SOUR INT, (@301)** *This command selects an internal gate source for the totalizer measurement on channel 301.*
- **COUN:GATE:POL ALO, (@301)** *This command sets an active low logic polarity at the gate input line of channel 301. This implies that a falling edge is a valid transition.*
- **COUN:CLK:POL ALO, (@301)** *This command sets an active low clock polarity for the totalizer measurement on channel 301.*
- **COUN:CLK:SOUR INT, (@301)** *This command selects an internal clock source for the totalizer measurement on channel 301.*
- **COUN:TOT:IVAL 0, (@301)** *This command sets an initial counter value of 0.*
- **COUN:TOT:UDOW:DIR UP, (@301)** *This command sets a counting up direction for the totalizer measurement on channel 301.*
- **COUN:TOT:INIT (@301)** *This command starts the totalizer measurement on channel 301.*
- **COUN:GATE:CONT ENAB, (@301)** *This command enables the gate of channel 301. The input signals are now allowed to pass.*
- **MEAS:COUN:DATA? (@301)** *This query returns the totalized value of the input signals.*
- ← **64838** *The totalized value thus far is returned.*

[SENSe:]COUNter:GATE:CONTRol

Syntax

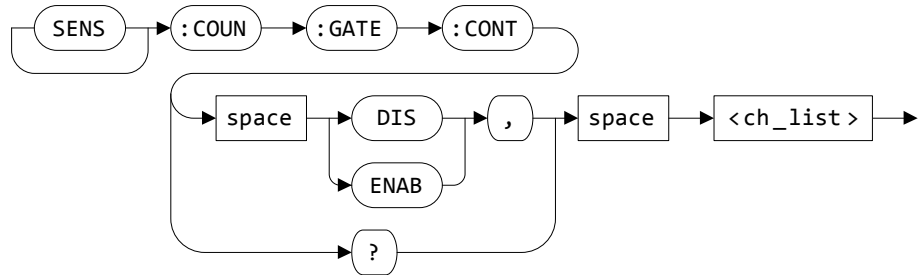

[SENSe:]COUNter:GATE:CONTRol <mode>, <ch_list>

This command is used to enable or disable the gate for the counter channel(s) specified in the <ch_list> parameter.

The valid options are:

- ENAB: Enables gate; input signals are allowed to pass through.
- DIS: Disables gate; input signals are not allowed to pass through.

[SENSe:]COUNter:GATE:CONTRol? <ch_list>

This query returns a string value that represents the gate status of each counter channel specified. Multiple responses are separated by commas.

Supported models

U2351A, U2352A, U2353A, U2354A, U2355A, U2356A, U2331A

Parameter

Item	Type	Range of values	Default value
mode	Discrete	DIS ENAB	DIS
ch_list	Channel list	(@301) (@302)	-

Example

This example illustrates how the `[SENSe:]COUNter:GATE:CONTRo1` command is used to enable the gate on counter channel 301.

- | | |
|--|--|
| → <code>*CLS; *RST</code> | <i>These commands clears and resets the instrument to its default settings.</i> |
| → <code>COUN:FUNC TOT, (@301)</code> | <i>This command selects the totalizer measurement for channel 301.</i> |
| → <code>COUN:TOT:INIT (@301)</code> | <i>This command starts the totalizer measurement on channel 301 with the instrument default values.</i> |
| → <code>COUN:GATE:CONT ENAB, (@301)</code> | <i>This command enables the gate of channel 301. The input signals are now allowed to pass; the totalizing process can begin.</i> |
| → <code>MEAS:COUN:DATA? (@301)</code> | <i>This query returns the totalized value of the input signals.</i> |
| ← <code>64838</code> | <i>The totalized value thus far is returned.</i> |
| → <code>COUN:GATE:CONT DIS (@301)</code> | <i>This command disables the gate of channel 301. The totalizing process is halted.</i> |
| → <code>MEAS:COUN:DATA? (@301)</code> | |
| ← <code>64838</code> | <i>The totalizing process is halted because the gate has been disabled.</i> |
| → <code>COUN:GATE:CONT ENAB, (@301)</code> | <i>This command enables the gate of channel 301. The input signals are now allowed to pass again; the totalizing process is resumed.</i> |
| → <code>MEAS:COUN:DATA? (@301)</code> | |
| ← <code>76434</code> | <i>The totalized value thus far is returned.</i> |

[SENSe:]COUNter:CLock:SOURce

Syntax

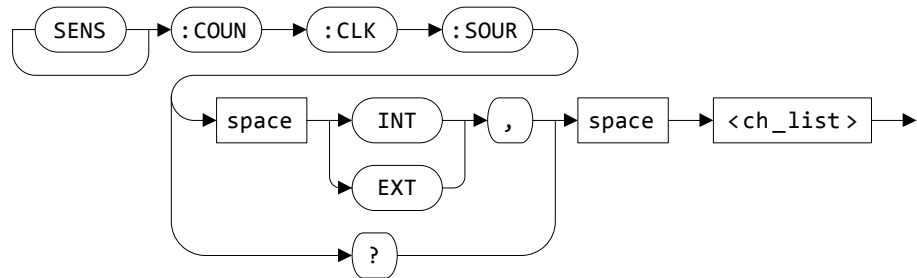

[SENSe:]COUNter:CLock:SOURce <mode>, <ch_list>

This command is used to set the clock source for the counter channel(s) specified in the <ch_list> parameter.

The valid options are:

- INTERNAL: Selects the DAQ device internal counter clock frequency (12 MHz) as the clock source.
- EXTERNAL: Selects the COUNT301_CLK or COUNT302_CLK pin as the counter clock source.

NOTE

- The clock frequency coming in from the COUNT301_CLK or COUNT302_CLK pin must be set in the DAQ device via the [SENSe:]COUNter:CLock:EXTERNAL command. For example, if a 10 MHz clock frequency is expected from the COUNT301_CLK or COUNT302_CLK pin, you must send the [SENSe:]COUNter:CLock:EXTERNAL 10000 command to the DAQ device.
- See “[SENSe:]COUNter:CLock:INTERNAL?” on page 148 for more information on how to return the internal counter clock frequency.
- See “[SENSe:]COUNter:CLock:EXTERNAL” on page 149 for more information on how to set the external counter clock frequency.

[SENSe:]COUNter:CLock:SOURce? <ch_list>

This query returns a string value that represents the clock source of each counter channel specified. Multiple responses are separated by commas.

Supported models

U2351A, U2352A, U2353A, U2354A, U2355A, U2356A, U2331A

Parameter

Item	Type	Range of values	Default value
mode	Discrete	INTernal EXTernal	INTernal
ch_list	Channel list	(@301)((@302)	-

See also

“[SENSe:]COUNter:CLock:INTernal?” on page 148

“[SENSe:]COUNter:CLock:EXTernal” on page 149

Example

This example illustrates how the **[SENSe:]COUNter:CLock:SOURce** command is used to set the clock source of counter channel 301 to an external clock source.

→ COUN:CLK:SOUR EXT, (@301)	<i>This command sets the instrument counter clock source to external. A 10 MHz clock frequency signal is supplied to the COUNT301_CLK pin.</i>
→ COUN:CLK:EXT 10000, (@301)	<i>Since we are expecting a 10 MHz clock frequency from the COUNT301_CLK pin, use this command to set the external counter clock frequency to 10 MHz.</i>
→ COUN:CLK:SOUR? (@301)	<i>This query returns the counter clock source for channel 301.</i>
← EXT	

[SENSe:]COUNter:CLock:INTernal?

Syntax

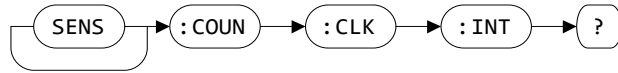

[SENSe:]COUNter:CLock:INTernal?

This query returns a string value that represents the internal clock frequency. The value returned is expressed in kilohertz (kHz).

Supported models

U2351A, U2352A, U2353A, U2354A, U2355A, U2356A, U2331A

See also

“[SENSe:]COUNter:CLock:SOURce” on page 146

Example

This example illustrates how the [SENSe:]COUNter:CLock:INTernal? query is used to return the internal clock frequency.

→ COUN:CLK:INT?

This query returns the internal clock frequency.

← 12000

The internal timebase frequency is returned – 12 MHz. This value is used when you set the counter clock source to the instrument internal clock source.

[SENSe:]COUNter:CLock:EXTernal

Syntax

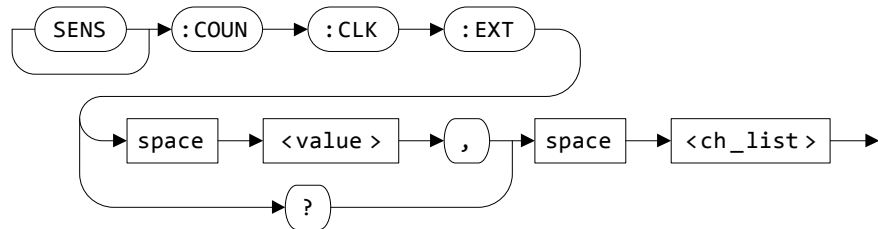

[SENSe:]COUNter:CLock:EXTernal <value>, <ch_list>

This command is used to set the external clock frequency for the counter channel(s) specified in the <ch_list> parameter. The frequency set in the <value> parameter must be the same as the frequency value supplied to the COUNT301_CLK or COUNT302_CLK pin when the counter clock source is set to EXTERNAL. The clock frequency is expressed in units of kilohertz (kHz).

NOTE

See “[SENSe:]COUNter:CLock:SOURce” on page 146 for more information on selecting a general purpose digital counter clock source.

[SENSe:]COUNter:CLock:EXTernal? <ch_list>

This query returns a string value that represents the external clock frequency of each counter channel specified. Multiple responses are separated by commas. The value returned is expressed in kilohertz (kHz).

Supported models

U2351A, U2352A, U2353A, U2354A, U2355A, U2356A, U2331A

Parameter

Item	Type	Range of values	Default value
value	Numeric	1000 kHz (1 MHz) to 10000 kHz (10 MHz)	0
ch_list	Channel list	(@301) (@302)	-

See also

“[\[SENSe:\]COUNter:CLock:SOURce](#)” on page 146

Example

This example illustrates how the `[SENSe:]COUNter:CLock:EXTernal` command is used to set the external clock frequency of counter channel 301.

→ <code>COUN:CLK:SOUR EXT, (@301)</code>	<i>This command sets the instrument counter clock source to the COUNT301_CLK pin. A 10 MHz clock frequency signal is supplied to the COUNT301_CLK pin.</i>
→ <code>COUN:CLK:EXT 10000, (@301)</code>	<i>Since we are expecting a 10 MHz clock frequency from the COUNT301_CLK pin, use this command to set the external counter clock frequency to 10 MHz.</i>
→ <code>COUN:CLK:EXT? (@301)</code>	<i>This query returns the external timebase frequency of channel 301.</i>
← <code>10000</code>	<i>The external timebase frequency is returned in kHz.</i>

[SENSe:]COUNter:CLock:POLarity

Syntax

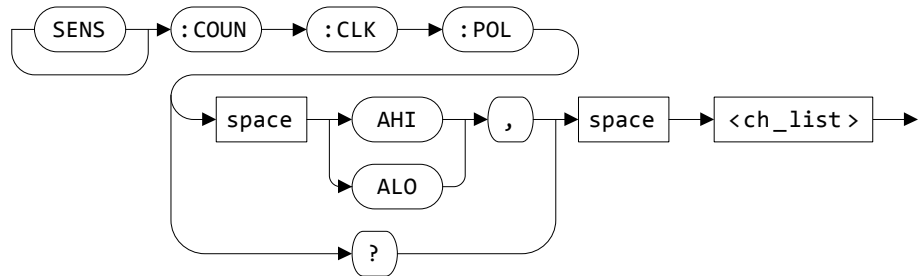

[SENSe:]COUNter:CLock:POLarity <mode>, <ch_list>

This command is used to set the clock polarity for the counter channel(s) specified in the <ch_list> parameter.

The valid options are:

- AHI: Active high polarity
- ALO: Active low polarity

[SENSe:]COUNter:CLock:POLarity? <ch_list>

This query returns a string value that represents the clock polarity of each counter channel specified. Multiple responses are separated by commas.

Supported models

U2351A, U2352A, U2353A, U2354A, U2355A, U2356A, U2331A

Parameter

Item	Type	Range of values	Default value
mode	Discrete	AHI ALO	AHI
ch_list	Channel list	(@301)((@302)	-

Example

This example illustrates how the **[SENSe:]COUNter:CLoCK:POLarity** command is used to change the clock polarity on counter channel 301.

- **COUN:FUNC TOT, (@301)** *This command selects the totalizer measurement for channel 301.*
- **COUN:GATE:SOUR INT, (@301)** *This command selects an internal gate source for the totalizer measurement on channel 301.*
- **COUN:GATE:POL ALO, (@301)** *This command sets an active low logic polarity at the gate input line of channel 301.*
- **COUN:CLK:POL ALO, (@301)** *This command sets an active low clock polarity for the totalizer measurement on channel 301. This implies that the instrument will count on the falling edge.*
- **COUN:CLK:SOUR INT, (@301)** *This command selects an internal clock source for the totalizer measurement on channel 301.*
- **COUN:TOT:IVAL 0, (@301)** *This command sets an initial counter value of 0.*
- **COUN:TOT:UDOW:DIR UP, (@301)** *This command sets a counting up direction for the totalizer measurement on channel 301.*
- **COUN:TOT:INIT (@301)** *This command starts the totalizer measurement on channel 301.*
- **COUN:GATE:CONT ENAB, (@301)** *This command enables the gate of channel 301. The input signals are now allowed to pass.*
- **MEAS:COUN:DATA? (@301)** *This query returns the totalized value of the input signals.*
- ← **64838** *The totalized value thus far is returned.*

[SENSe:]COUNter:TOTalize:IVALue

Syntax

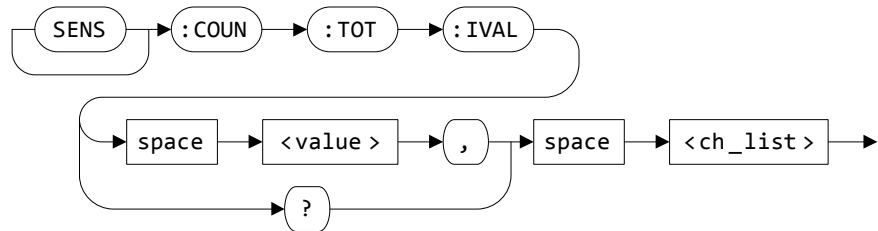

[SENSe:]COUNter:TOTalize:IVALue <value>, <ch_list>

This command sets the initial counter value for the counter channel(s) specified in the <ch_list> parameter.

[SENSe:]COUNter:TOTalize:IVALue? <ch_list>

This query returns a numeric value that represents the initial counter value of each counter channel specified. Multiple responses are separated by commas.

Supported models

U2351A, U2352A, U2353A, U2354A, U2355A, U2356A, U2331A

Parameter

Item	Type	Range of values	Default value
value	Numeric	0 to 2147483647 ($2^{31} - 1$)	0
ch_list	Channel list	(@301)(@302)	-

Example

This example illustrates how the `[SENSe:]COUNter:TOTalize:IVALue` command is used to set an initial counter value on counter channel 301.

- `COUN:FUNC TOT, (@301)` *This command selects the totalizer measurement for channel 301.*
- `COUN:GATE:SOUR INT, (@301)` *This command selects an internal gate source for the totalizer measurement on channel 301.*
- `COUN:GATE:POL ALO, (@301)` *This command sets an active low logic polarity at the gate input line of channel 301.*
- `COUN:CLK:POL AHI, (@301)` *This command sets an active high clock polarity for the totalizer measurement on channel 301.*
- `COUN:CLK:SOUR INT, (@301)` *This command selects an internal clock source for the totalizer measurement on channel 301.*
- `COUN:TOT:IVAL 1000, (@301)` *This command sets an initial counter value of 1000.*
- `COUN:TOT:UDOW:DIR UP, (@301)` *This command sets a counting up direction for the totalizer measurement on channel 301.*
- `COUN:TOT:INIT (@301)` *This command starts the totalizer measurement on channel 301.*
- `MEAS:COUN:DATA? (@301)` *This query returns the totalized value of the input signals.*
- ← `1000` *The totalized value thus far is returned. Since the general purpose digital counter gate has not been enabled the totalized value thus far is the initial counter value.*
- `COUN:GATE:CONT ENAB, (@301)` *This command enables the gate of channel 301. The input signals are now allowed to pass.*
- `MEAS:COUN:DATA? (@301)`
- ← `65838` *The totalized value thus far is returned.*

[SENSe:]COUNter:TOTalize:INITiate

Syntax

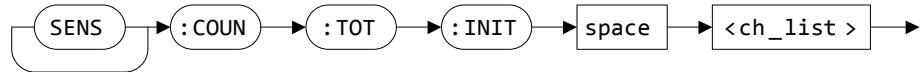

[SENSe:]COUNter:TOTalize:INITiate <ch_list>

This command initiates a totalizer measurement on the counter channel(s) specified in the <ch_list> parameter.

Supported models

U2351A, U2352A, U2353A, U2354A, U2355A, U2356A, U2331A

Parameter

Item	Type	Range of values	Default value
ch_list	Channel list	(@301)(@302)	-

Example

This example illustrates how the [SENSe:]COUNter:TOTalize:INITiate command is used to initiate the totalizer measurement on counter channel 301.

- *CLS; *RST *These commands clears and resets the instrument to its default settings.*
- COUN:FUNC TOT, (@301) *This command selects the totalizer measurement for channel 301.*
- COUN:TOT:INIT (@301) *This command starts the totalizer measurement on channel 301 with the instrument default values.*
- COUN:GATE:CONT ENAB, (@301) *This command enables the gate of channel 301. The input signals are now allowed to pass.*

[SENSe:]COUNter:TOTalize:CLEar

Syntax

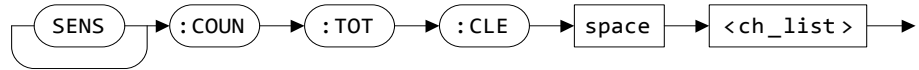

[SENSe:]COUNTER:TOTALize:CLEar <ch_list>

This command clears the totaled value thus far on the counter channel(s) specified in the <ch_list> parameter.

Supported models

U2351A, U2352A, U2353A, U2354A, U2355A, U2356A, U2331A

Parameter

Item	Type	Range of values	Default value
ch_list	Channel list	(@301)(@302)	-

Remarks

This command clears the counter to zero. Sending this command will not return the value of the general purpose digital counter to the initialized counter value. For more information on setting an initial counter value see “[SENSe:]COUNter:TOTALize:IVALue” on page 153.

Example

This example illustrates how the `[SENSe:]COUNter:TOTalize:CLEar` command is used to clear the counter values of counter channel 301.

→ <code>*CLS; *RST</code>	<i>These commands clears and resets the instrument to its default settings.</i>
→ <code>COUN:FUNC TOT, (@301)</code>	<i>This command selects the totalizer measurement for channel 301.</i>
→ <code>COUN:TOT:INIT (@301)</code>	<i>This command starts the totalizer measurement on channel 301 with the instrument default values.</i>
→ <code>COUN:GATE:CONT ENAB, (@301)</code>	<i>This command enables the gate of channel 301.</i>
→ <code>MEAS:COUN:DATA? (@301)</code>	<i>This query returns the totalized value of the input signals.</i>
← <code>64838</code>	<i>The totalized value thus far is returned.</i>
→ <code>COUN:GATE:CONT DIS (@301)</code>	<i>This command disables the gate of channel 301.</i>
→ <code>COUN:ABOR (@301)</code>	<i>This command aborts the current totalizer measurement in progress.</i>
→ <code>MEAS:COUN:DATA? (@301)</code>	
← <code>75643</code>	<i>The returned value "75643" is the last acquired value before the totalizer measurement is aborted.</i>
→ <code>SENS:COUN:TOT:CLE (@301)</code>	<i>This command clears all the acquired counter values in the output buffer.</i>
→ <code>MEAS:COUN:DATA? (@301)</code>	
← <code>0</code>	

[SENSe:]COUNter:TOTAlize:UDOWn:SOURce

Syntax

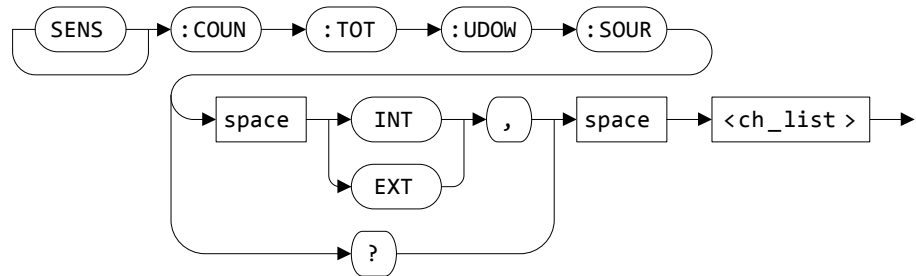

[SENSe:]COUNter:TOTAlize:UDOWn:SOURce <mode>, <ch_list>

This command is used to set the up/down counting source for the counter channel(s) specified in the <ch_list> parameter.

The valid options are:

- INTERNAL: The up/down counting source is controlled over a remote interface using SCPI commands.
- EXTERNAL: The up/down counting source is controlled by the COUNT301_UPDOWN or COUNT302_UPDOWN pins.

[SENSe:]COUNter:TOTAlize:UDOWn:SOURce? <ch_list>

This query returns a string value that indicates the up/down counting source of each counter channel specified. Multiple responses are separated by commas.

Supported model

U2351A, U2352A, U2353A, U2354A, U2355A, U2356A, U2331A

Parameter

Item	Type	Range of values	Default value
mode	Discrete	INTERNAL EXTERNAL	INTERNAL
ch_list	Channel list	(@301)(@302)	-

Example

This example illustrates how the `[SENSe:]COUNter:TOTalize:UDOWn:SOURce` command is used to set the `COUNT301_UPDOWN` pin as the up/down counting source on counter channel 301.

- `COUN:FUNC TOT, (@301)` *This command selects the totalizer measurement for channel 301.*
- `COUN:GATE:SOUR INT, (@301)` *This command selects an internal gate source for the totalizer measurement on channel 301.*
- `COUN:GATE:POL AHI, (@301)` *This command sets an active high logic polarity at the gate input line of channel 301.*
- `COUN:CLK:POL AHI, (@301)` *This command sets an active high clock polarity for the totalizer measurement on channel 301.*
- `COUN:CLK:SOUR INT, (@301)` *This command selects an internal clock source for the totalizer measurement on channel 301.*
- `COUN:TOT:IVAL 0, (@301)` *This command sets an initial counter value of 0.*
- `COUN:TOT:UDOW:SOUR EXT, (@301)` *This command selects an external up/down counting source for the totalizer measurement on channel 301. This implies that the input signal from the `COUNT301_UPDOWN` pin will be used as the up/down counting source.*
- `COUN:TOT:UDOW:DIR UP, (@301)` *This command sets a counting up direction for the totalizer measurement on channel 301.*
- `COUN:TOT:INIT (@301)` *This command starts the totalizer measurement on channel 301.*
- `COUN:GATE:CONT ENAB, (@301)` *This command enables the gate of channel 301. The input signals are now allowed to pass.*
- `MEAS:COUN:DATA? (@301)` *This query returns the totalized value of the input signals.*
- ← `64838` *The totalized value thus far is returned.*

[SENSe:]COUNter:TOTAlize:UDOWn:DIRection

Syntax

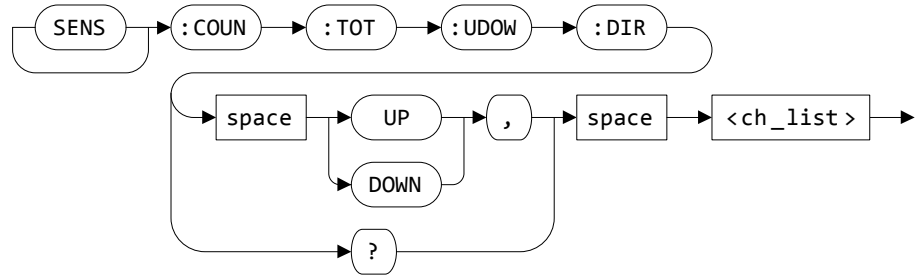

[SENSe:]COUNter:TOTAlize:UDOWn:DIRection <mode>, <ch_list>

This command is used to set the direction of the up/down counting process for the counter channel(s) specified in the <ch_list> parameter.

The valid options are:

- UP: Counting up direction
- DOWN: Counting down direction

[SENSe:]COUNter:TOTAlize:UDOWn:DIRection? <ch_list>

This query returns a string value that indicates the direction of the counting process of each counter channel specified. Multiple responses are separated by commas.

Supported models

U2351A, U2352A, U2353A, U2354A, U2355A, U2356A, U2331A

Parameter

Item	Type	Range of values	Default value
mode	Discrete	UP DOWN	UP
ch_list	Channel list	(@301)(@302)	-

Example

This example illustrates how the **[SENSe:]COUNter:TOTalize:UDOWn:DIRection** command is used to set a counting down direction for the totalizer measurement on counter channel 301.

- **COUN:FUNC TOT, (@301)** *This command selects the totalizer measurement for channel 301.*
- **COUN:GATE:SOUR INT, (@301)** *This command selects an internal gate source for the totalizer measurement on channel 301.*
- **COUN:GATE:POL AHI, (@301)** *This command sets an active high logic polarity at the gate input line of channel 301.*
- **COUN:CLK:POL AHI, (@301)** *This command sets an active high clock polarity for the totalizer measurement on channel 301.*
- **COUN:CLK:SOUR INT, (@301)** *This command selects an internal clock source for the totalizer measurement on channel 301.*
- **COUN:TOT:IVAL 0, (@301)** *This command sets an initial counter value of 0.*
- **COUN:TOT:UDOW:DIR DOWN, (@301)** *This command sets a counting down direction for the totalizer measurement on channel 301.*
- **COUN:TOT:INIT (@301)** *This command starts the totalizer measurement on channel 301.*
- **COUN:GATE:CONT ENAB, (@301)** *This command enables the gate of channel 301. The input signals are now allowed to pass.*
- **MEAS:COUN:DATA? (@301)** *This query returns the totalized value of the input signals.*
- ← **6483843** *The totalized value thus far is returned.*
- **MEAS:COUN:DATA? (@301)**
- ← **4348901** *The totalized value thus far is returned.*

THIS PAGE HAS BEEN INTENTIONALLY LEFT BLANK.

10 SOURce Subsystem

SOURce:VOLTage[:LEVel]	164
SOURce:VOLTage:POLarity	166
SOURce:VOLTage:RSouRCe	168
SOURce:VOLTage:RVOLTage	170
SOURce:DIGital:DATA	172
SOURce:DIGital:DATA:BIT	174

This chapter describes the SOURce commands used to program the U2300A Series DAQ device over a remote interface. Use the SOURce commands to change the AO channel settings prior to making a single voltage output. You can also output digital data to the DIO channels.

SOURCE:VOLTage[:LEVel]

Syntax

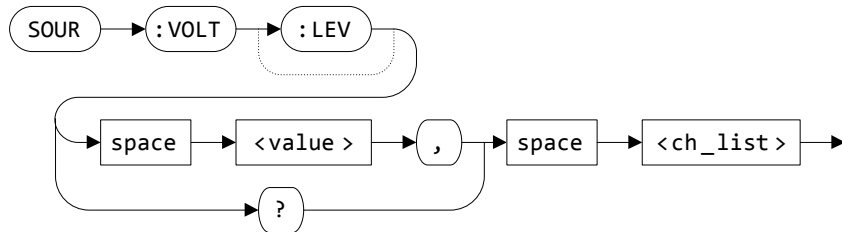

SOURCE:VOLTage[:LEVel] <value>, <ch_list>

This command is used to output a single voltage level to the AO channel(s) specified in the <ch_list> parameter. The voltage set is supplied as soon as the command is executed.

NOTE

This command receives a voltage value, scales it to the proper binary value and writes a binary value to the designated AO channel. After setting the desired voltage level, the command closes the corresponding output relays and enable the outputs from the specified channel(s). You do not need to send the OUTPUT ON command to enable the output.

SOURCE:VOLTage[:LEVel]? <ch_list>

This query returns a numeric value that represents the output voltage level of each analog channel specified. Multiple responses are separated by commas. The value returned is expressed in volts (V).

Supported models

U2351A, U2353A, U2355A, U2356A, U2331A

Parameter

Item	Type	Range of values	Default value
value	Numeric	-10 V to +10 V (12-bits resolution)	0 V
ch_list	Channel list	(@201)(@202)	-

Remarks

- If the output has already been enabled (via the **OUTPUT ON**) command, sending this command will generate an error. You must first disable the output by sending the **OUTPUT OFF** command.
- This command is not supported by the U2352A and U2354A DAQ devices.

See also

“**SOURce:VOLTage:POLarity**” on page 166

“**SOURce:VOLTage:RSouRCe**” on page 168

“**SOURce:VOLTage:RVOLTage**” on page 170

Example

This example illustrates how the **SOURce:VOLTage[:LEVe1]** command is used to output a 5 V DC power supply for channel 201.

→ SOUR:VOLT 5, (@201)	<i>This command outputs a 5 V DC power supply from channel 201.</i>
→ SOUR:VOLT? (@201)	<i>This query returns the current output voltage level from channel 201.</i>
← 5	

SOURce:VOLTage:POLarity

Syntax

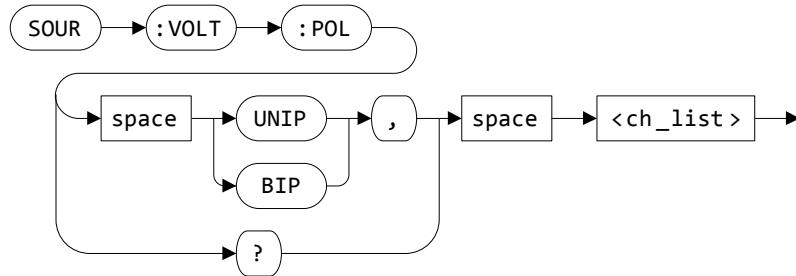

SOURce:VOLTage:POLarity <mode>, <ch_list>

This command is used to set the polarity of the AO channel(s) specified in the <ch_list> parameter. This command is applicable for single voltage output operations.

The valid options are:

- UNIPolar
- BIPolar

SOURce:VOLTage:POLarity? <ch_list>

This query returns a string value that represents the polarity of each AO channel specified. Multiple responses are separated by commas.

Supported models

U2351A, U2353A, U2355A, U2356A, U2331A

Parameter

Item	Type	Range of values	Default value
mode	Discrete	UNIPolar BIPolar	BIPolar
ch_list	Channel list	(@201)(@202)	-

Remarks

- This command will force reset the output voltage level to zero if the voltage output is set to a negative voltage level.
- This command is not supported by the U2352A and U2354A DAQ devices.

See also

“**SOURce:VOLTage[:LEVel]**” on page 164

“**SOURce:VOLTage:RSouRCe**” on page 168

“**SOURce:VOLTage:RVOLTage**” on page 170

Example

This example illustrates how the **SOURce:VOLTage[:LEVel]** command is used to output a 7.5 V DC power supply for AO channel 201. The **SOURce:VOLTage:POLarity** command is used to change the polarity of AO channel 201.

→ SOUR:VOLT:POL UNIP, (@201)	<i>This command changes the polarity of channel 201 to unipolar. This limits the output level to a positive voltage level.</i>
→ SOUR:VOLT:RSRC EXT, (@201)	<i>This command changes the reference voltage source of channel 201 to an external source.</i>
→ SOUR:VOLT:RVOL 5	<i>This command selects an external reference voltage value of 5 V.</i>
→ SOUR:VOLT 7.5, (@201)	<i>This command outputs a 7.5 V DC power supply from channel 201.</i>

SOURce:VOLTage:RSouRCe

Syntax

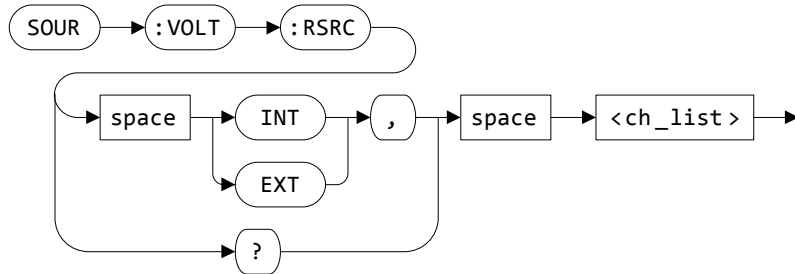

SOURce:VOLTage:RSouRCe <mode>, <ch_list>

This command is used to set the reference voltage source for the AO channel(s) specified in the <ch_list> parameter. This command is applicable for single voltage output operations.

The valid options are:

- INTernal: Selects the internal on-board reference voltage as the reference voltage source.
- EXTernal: Selects the AO_EXT_REF pin is as the reference voltage source.

NOTE

- The reference voltage coming in from the AO_EXT_REF pin must be set in the DAQ device via the SOURce:VOLTage:RVOLTage command. For example, if a 5 V reference voltage is expected from the AO_EXT_REF pin, you must send the SOURce:VOLTage:RVOLTage 5 command to the DAQ device.
- See **"SOURce:VOLTage:RVOLTage"** on page 170 for more information on how to set the external reference voltage value.

SOURce:VOLTage:RSouRCe? <ch_list>

This query returns a string value that represents the reference voltage source of each AO channel specified. Multiple responses are separated by commas.

Supported models

U2351A, U2353A, U2355A, U2356A, U2331A

Parameter

Item	Type	Range of values	Default value
mode	Discrete	INTERNAL EXTERNAL	INTERNAL
ch_list	Channel list	(@201)(@202)	-

See also

“SOURCE:VOLTage[:LEVel]” on page 164

“SOURCE:VOLTage:POLarity” on page 166

“SOURCE:VOLTage:RVOLTage” on page 170

Example

This example illustrates how the **SOURCE:VOLTage[:LEVel]** command is used to output a 7.5 V DC power supply for AO channel 201. The **SOURCE:VOLTage:RSOURCE** command is used to change the reference voltage source of AO channel 201.

- **SOURCE:VOLT:POL UNIP, (@201)** *This command changes the polarity of channel 201 to unipolar.*
- **SOURCE:VOLT:RSRC EXT, (@201)** *This command sets the instrument reference voltage source to the AO_EXT_REF pin. A 5 V voltage source is supplied to the AO_EXT_REF pin.*
- **SOURCE:VOLT:RVOL 5** *Since we are expecting a 5 V voltage source from the AO_EXT_REF pin, this command is used to set the external reference voltage to 5 V.*
- **SOURCE:VOLT 7.5, (@201)** *This command outputs a 7.5 V DC power supply from channel 201.*

SOURce:VOLTage:RVOLTage

Syntax

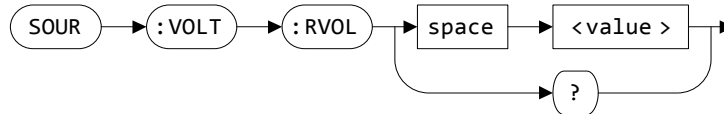

SOURce:VOLTage:RVOLTage <value>

This command is used to set the external reference voltage value. The reference voltage set in the <value> parameter must be the same as the voltage value supplied to the AO_EXT_REF pin when the reference voltage source is set to **EXtErnal**. The reference voltage value is expressed in units of volts (V).

NOTE

See “**SOURce:VOLTage:RSouRCe**” on page 168 for more information on selecting a reference voltage source.

SOURce:VOLTage:RVOLTage?

This query returns a string value that represents the external reference voltage value. The value returned is expressed in volts (V).

Supported models

U2351A, U2353A, U2355A, U2356A, U2331A

Parameter

Item	Type	Range of values	Default value
value	Numeric	0 < value ≤ 10	10 V

Remarks

The reference voltage value cannot be set to zero or a negative value.

See also

“**SOURce:VOLTage[:LEVel]**” on page 164

“**SOURce:VOLTage:POLarity**” on page 166

“**SOURce:VOLTage:RVOLTage**” on page 170

Example

This example illustrates how the **SOURce:VOLTage[:LEVel]** command is used to output a 7.5 V DC power supply for AO channel 201. The **SOURce:VOLTage:RVOLTage** command is used to change the reference voltage level.

- **SOUR:VOLT:POL UNIP, (@201)** *This command changes the polarity of channel 201 to unipolar.*
- **SOUR:VOLT:RSRC EXT, (@201)** *This command sets the instrument reference voltage source to the AO_EXT_REF pin. A 5 V voltage source is supplied to the AO_EXT_REF pin.*
- **SOUR:VOLT:RVOL 5** *Since we are expecting a 5 V voltage source from the AO_EXT_REF pin, this command is used to set the external reference voltage to 5 V.*
- **SOUR:VOLT 7.5, (@201)** *This command outputs a 7.5 V DC power supply from channel 201.*

SOURce:DIGital:DATA

Syntax

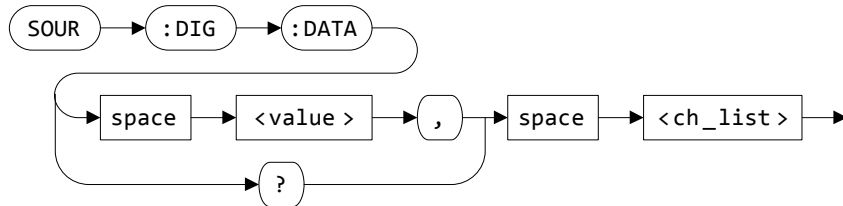

SOURce:DIGital:DATA <value>, <ch_list>

This command is used to output a 4-bit or 8-bit digital pattern to the DIO channel(s) specified in the **<ch_list>** parameter. The specified DIO channels have to be configured as **OUTPUT**, prior to sourcing any digital data.

NOTE

To configure the DIO channel for output operation, see **“CONFigure:DIGital:DIRection”** on page 56.

SOURce:DIGital:DATA? <ch_list>

This query returns a numeric value that represents the digital data of each DIO channel specified. Multiple responses are separated by commas.

Supported models

U2351A, U2352A, U2353A, U2354A, U2355A, U2356A, U2331A

Parameter

Item	Type	Range of values	Default value
value	Numeric	– Channel 501 and 502: 0 to 255 – Channel 503 and 504: 0 to 15	-
ch_list	Channel list	U2351A/53A/55A/56A/31A: (@501) to (@504) ^[a]	-

[a] Port A: Channel 501 (8-bits)
Port B: Channel 502 (8-bits)
Port C: Channel 503 (4-bits)
Port D: Channel 504 (4-bits)

Remarks

Prior to using this command, the DIO channel has to be configured as **OUTPUT**; else a system error will be generated. Using this command or query right after a system reset (***RST**) will also generate a system error. This is because after a system reset, the DIO channel by default is set to **INPUT**.

See also

“**CONFigure:DIGital:DIRection**” on page 56

Example

This example illustrates how the **SOURce:DIGital:DATA** command is used to output a digital data value of 256 for DIO channel 501. The **CONFigure:DIGital:DIRection** command is used to configure the DIO channel for output operations.

```

→ CONF:DIG:DIR OUTP,          This command configures channel 501 for
  (@501)                       output operations.
→ SOUR:DIG:DATA 256,          This command outputs a digital data value of
  (@501)                       256 through channel 501.
→ SOUR:DIG:DATA? (@501)      This query returns the digital data value in
                               channel 501.
← 256

```

SOURce:DIGital:DATA:BIT

Syntax

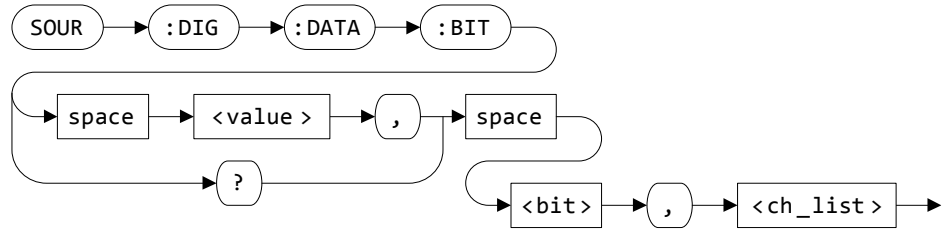

SOURce:DIGital:DATA:BIT <value>, <bit>, <ch_list>

This command sets or clears individual bits on the DIO channel(s) specified in the **<ch_list>** parameter. The specified DIO channels have to be configured as **OUTPut**, prior to sourcing any digital data.

NOTE

Once a channel is configured as **OUTPut**, all bits within that channel are set as output. To configure the DIO channel for output operation, see **“CONFigure:DIGital:DIRection”** on page 56.

SOURce:DIGital:DATA:BIT? <bit>, <ch_list>

This query returns a boolean value of 1 (logic high) or 0 (logic low) for the specified bit within the specified channel.

Supported models

U2351A, U2352A, U2353A, U2354A, U2355A, U2356A, U2331A

Parameter

Item	Type	Range of values	Default value
value	Numeric	0 1	0
bit	Numeric	– Channel 501 and 502: 0 to 7 – Channel 503 and 504: 0 to 3	-
ch_list	Channel list	U2351A/53A/55A/56A/31A: (@501) to (@504) ^[a]	-

[a] Port A: Channel 501 (8-bits)
Port B: Channel 502 (8-bits)
Port C: Channel 503 (4-bits)
Port D: Channel 504 (4-bits)

Remarks

Prior to using this command, the DIO channel has to be configured as **OUTPUT**; else a system error will be generated. Using this command or query right after a system reset (***RST**) will also generate a system error. This is because after a system reset, the DIO channel by default is set to **INPUT**.

See also

[“CONF:DIG:DIR:DIRection”](#) on page 56

Example

This example illustrates how the **SOURce:DIGital:DATA:BIT** command is used to set bit 4 of DIO channel 501 to a logic high state. The **CONF:DIGital:DIRection** command is used to configure the DIO channel for output operations.

```
→ CONF:DIG:DIR OUTP,          This command configures channel 501 for
  (@501)                       output operations.
→ SOUR:DIG:DATA:BIT 1,4,      This command sets bit 4 of channel 501 to 1
  (@501)                       (logic high).
→ SOUR:DIG:DATA:BIT? 4,      This query returns the logic state of bit 4 in
  (@501)                       channel 501.
← 1
```

THIS PAGE HAS BEEN INTENTIONALLY LEFT BLANK.

11 SYSTEM Subsystem

SYSTEM:CDEscription? 178
SYSTEM:ERRor? 179

This section describes the SYSTEM commands used to program the U2300A Series DAQ device over a remote interface. The SYSTEM:ERRor? query can be used to return the error stored in the DAQ device error queue while the SYSTEM:CDEscription? query can be used to return the slot and chassis number of a DAQ device when slotted into a U2781A USB modular instrument chassis.

SYSTem:CDEscription?

Syntax



SYSTem:CDEscription?

This command is used when the U2300A Series DAQ device is slotted into a U2781A USB modular instrument chassis. It identifies and returns the slot and chassis number that the module is slotted into.

Supported models

U2351A, U2352A, U2353A, U2354A, U2355A, U2356A, U2331A

Remarks

This command is only applicable when the DAQ device is used in the U2781A USB modular instrument chassis. If the DAQ device is in standalone mode, using this command will return the value “7,0”.

NOTE

For more information on identifying multiple modules or chassis connected to the same PC host, see “Identifying Modules Location” in the *U2781A USB Modular Instrument Chassis User’s Guide*.

Example

This example illustrates how the **SYSTem:CDEscription?** query is used to identify and return the geographical address of the DAQ device.

→ SYST:CDES?

This query returns the slot and chassis number that the DAQ device is plugged into.

← 5,2

The returned value “5,2” indicates that the DAQ device is slotted into slot number 5 of chassis number 2.

SYSTem:ERRor?

Syntax

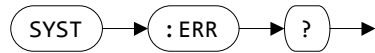

SYSTem:ERRor?

This query returns the next error number and its corresponding message string from the DAQ device error queue.

Errors are retrieved in first-in-first-out (FIFO) order. The first error returned is the first error that was stored. Reading this error will clear this error allowing the next stored error to be read (if there are other errors stored). Once you have read all of the interface-specific errors, the errors in the global error queue will be retrieved.

NOTE

See [Chapter 16, "Error Messages"](#) on page 239 for a list of all error numbers and their respective message string.

Supported models

U2351A, U2352A, U2353A, U2354A, U2355A, U2356A, U2331A

Remarks

- If more than 10 errors have occurred, the last error stored in the queue (the most recent error) is replaced with error number **-350, "Queue overflow"**. No additional errors are stored until you remove the previously stored errors from the queue.
- If no errors have occurred when you read the error queue, the instrument responds with **+0, "No error"**.
- Error conditions are also summarized in the Status Byte Register.
- The interface-specific and global error queues are cleared by the clear status (***CLS**) command and when the power is cycled. The error queue will not be cleared by a factory reset (***RST**) command.

See also

***CLS** on page 224

***RST** on page 232

***SRE** on page 234

Example

This example illustrates how the **SYSTem:ERRor?** query is used to read the errors stored in the DAQ device error queue.

→ SYST:ERR?	<i>This command reads the error(s) stored in the DAQ device error queue.</i>
← +0, "No error"	<i>The returned value "+0" indicates that there are no errors recorded.</i>
→ ROUT ENAB 1, (@201)	<i>This incomplete command (missing colon) generates a command syntax error when sent.</i>
→ SYST:ERR?	
← -113, "Undefined header"	<i>The returned value "-113" indicates that an invalid command was specified.</i>

12 TRIGger Subsystem

TRIGger:SOURce	182
TRIGger:TYPe	184
TRIGger:DCouNT	187
TRIGger:ATRIgger:SOURce	189
TRIGger:ATRIgger:CONDition	192
TRIGger:ATRIgger:HTHReshold	195
TRIGger:ATRIgger:LTHReshold	197
TRIGger:DTRiGger:POLarity	199

This chapter describes the TRIGger commands used to program the U2300A Series DAQ device over a remote interface. Use the TRIGger commands to set the AI trigger source and type. You can also configure the analog trigger settings.

TRIGger:SOURce

Syntax

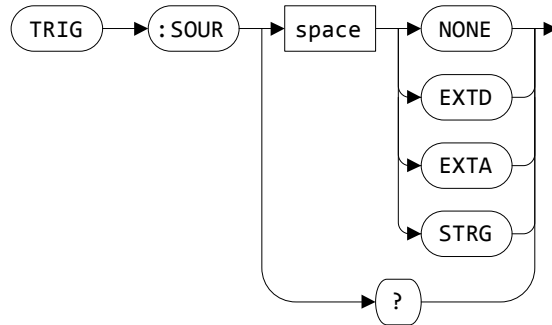

TRIGger:SOURce <mode>

This command is used to set the trigger source for input operations.

The valid options are:

- NONE: Immediate triggering.
- EXTD: Selects the external digital trigger (EXTD_AI_TRIG) pin as the triggering source.
- EXTA: Selects the external analog trigger as the triggering source. See [“TRIGger:ATRIGger:SOURce”](#) on page 189 for more information on setting the analog trigger source.
- STRG: Star triggering.

NOTE

- Star triggering (STRG) is used when the DAQ device is connected into the U2781A USB modular instrument chassis.
- For more information on selecting a trigger source, see “Trigger Sources” in the *Keysight U2300A Series USB Multifunction Data Acquisition Devices User’s Guide*.

TRIGger:SOURce?

This query returns a string value that represents the trigger source selected for input operations.

Supported models

U2351A, U2352A, U2353A, U2354A, U2355A, U2356A, U2331A

Parameter

Item	Type	Range of values	Default value
mode	Discrete	NONE EXTD EXTA STRG	NONE

Remarks

Only **POST** trigger type is allowed when immediate triggering (**NONE**) is selected. For more information on available trigger types, see “**TRIGger:TYPe**” on page 184.

Example

This example illustrates how the **TRIGger:SOURce** command is used to select the **EXTD_AI_TRIG** pin as the input trigger source.

- **ROUT:SCAN (@101)** *This command sets the instrument to monitor channel 101.*
- **ACQ:SRAT 1000** *This command sets the analog input sampling rate to 1 kHz.*
- **ACQ:POIN 100** *This command sets the instrument to acquire 100 sample points.*
- **TRIG:SOUR EXTD** *This command sets the **EXTD_AI_TRIG** pin as the input triggering source.*
- **TRIG:DTRG:POL POS** *This command sets a positive-edge trigger condition for the digital trigger source.*
- **TRIG:TYP POST** *This command set a post-trigger acquisition for the analog input.*
- **DIG** *This command starts the single-shot acquisition process when a positive-edge digital signal is received from the **EXTD_AI_TRIG** pin.*

TRIGger:TYPe

Syntax

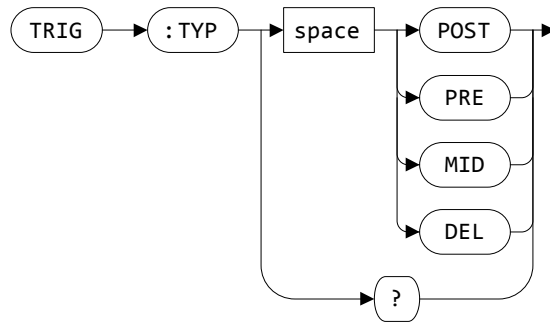

TRIGger:TYPe <mode>

This command is used to set the trigger type for input operations.

The valid options are:

- POST (Post-trigger): Input is acquired immediately after the trigger condition is met.
- PRE (Pre-trigger): Input is acquired immediately and is stopped when the trigger condition is met.
- MID (Mid-trigger): Input is acquired before and after the trigger condition is met. The sample points acquired before and after the trigger is equally divided.
- DEL (Delay-trigger): Input is acquired when the delay count reaches zero. The delay count starts immediately after the trigger condition is met.

NOTE

- See **“TRIGger:DCouNT”** on page 187 for more information on how to set a delay counter value.
- For more information on selecting a trigger type, see “Trigger types” in the *Keysight U2300A Series USB Multifunction Data Acquisition Devices User’s Guide*.

TRIGger:TYPe?

This query returns a string value that represents the trigger type selected for input operations.

Supported models

U2351A, U2352A, U2353A, U2354A, U2355A, U2356A, U2331A

Parameter

Item	Type	Range of values	Default value
mode	Discrete	POST PRE MID DEL	POST

See also

[“TRIGger:DCouNT”](#) on page 187

Example

This example illustrates how the **TRIGger:TYPE** command is used to select a delay-trigger acquisition as the input trigger type.

→ ROUT:SCAN (@101)	<i>This command sets the instrument to monitor channel 101.</i>
→ ACQ:SRAT 1000	<i>This command sets the analog input sampling rate to 1 kHz.</i>
→ ACQ:POIN 100	<i>This command sets the instrument to acquire 100 sample points.</i>
→ TRIG:SOUR EXT	<i>This command sets the EXT_AI_TRIG pin as the input triggering source.</i>
→ TRIG:DTRG:POL POS	<i>This command sets a positive-edge trigger condition for the digital trigger source.</i>
→ TRIG:TYP DEL	<i>This command sets a delay-trigger acquisition for the analog input.</i>
→ TRIG:DCNT 240000000	<i>This command sets the delay-trigger acquisition counter value.</i>
→ DIG	<i>This command starts the single-shot acquisition process once the delay count reaches zero. The delay count starts when a positive-edge digital signal is received from the EXT_AI_TRIG pin.</i>

TRIGger:DCouNT

Syntax

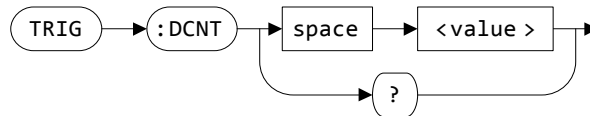

TRIGger:DCouNT <value>

This command is used to set the delay counter value. When the count reaches zero, the counter stops and the DAQ device starts acquiring data. The count set in the <value> parameter will be used when the input trigger type is set to DEL (delay-trigger). Set the clock source using the **CONFigure:TIMEbase:SOURce** command.

NOTE

- See “**TRIGger:TYPe**” on page 184 for more information on selecting an input trigger type.
- See “**CONFigure:TIMEbase:SOURce**” on page 58 for more information on selecting a timebase/clock source.

TRIGger:DCouNT?

This query returns a numeric value that represents the delay count value.

Supported models

U2351A, U2353A, U2355A, U2356A, U2331A

Parameter

Item	Type	Range of values	Default value
value	Numeric	0 to 2147483647 (31-bits) ^[a]	0

[a] The delay count parameter is subjected to the following constraints:
 Delay count ≥ 0
 Delay count $< 0x7fffffff$

See also

[“CONFigure:TIMEbase:SOURce”](#) on page 58

[“TRIGger:TYPe”](#) on page 184

Example

This example illustrates how the **TRIGger:DCouNT** command is used to set a delay counter value of 240000000. This will set a delay time of 5 seconds (240000000/48 MHz).

→ ROUT:SCAN (@101)	<i>This command sets the instrument to monitor channel 101.</i>
→ ACQ:SRAT 1000	<i>This command sets the analog input sampling rate to 1 kHz.</i>
→ ACQ:POIN 100	<i>This command sets the instrument to acquire 100 sample points.</i>
→ TRIG:SOUR EXT	<i>This command sets the EXT_D_AI_TRIG pin as the input triggering source.</i>
→ TRIG:DTRG:POL POS	<i>This command sets a positive-edge trigger condition for the digital trigger source.</i>
→ TRIG:TYP DEL	<i>This command sets a delay-trigger acquisition for the analog input.</i>
→ TRIG:DCNT 240000000	<i>This command sets the delay-trigger acquisition counter value. This implies that channel 101 will start acquiring data 5 seconds (240000000 / 48 MHz)^[1] after the trigger condition occurs.</i>
→ DIG	<i>This command starts the single-shot data acquisition process when all trigger conditions are met.</i>

[1] Where 48 MHz is the master clock source on board the U2300A Series DAQ device. If you wish to supply your own clock source (with an external clock), see [“CONFigure:TIMEbase:SOURce”](#) on page 58 and [“CONFigure:TIMEbase:ECLock”](#) on page 60.

TRIGger:ATRiGger:SOURce

Syntax

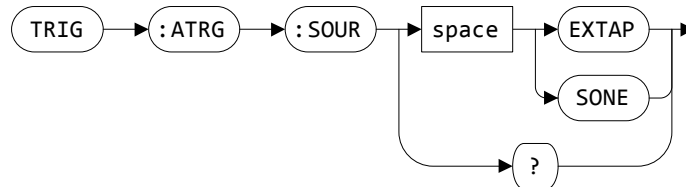

TRIGger:ATRiGger:SOURce <mode>

This command is used to set the analog trigger source for the AI trigger control.

The valid options are:

- EXTAP: Selects the external analog trigger (EXTA_TRIG) pin as the analog triggering source.
- SONE: Selects the first scanned channel of the multiplexing DAQ device as the analog triggering source. The first channel in the instrument scan list will be set as the analog trigger source.

NOTE

- This is an adjunct command for the TRIGger:SOURce EXTAP command.
- Use the ROUTe:SCAN command to determine the first channel in the instrument scan list.

TRIGger:ATRiGger:SOURce?

This query returns a string value that represents the analog trigger source selected for the AI trigger control.

Supported models

U2351A, U2352A, U2353A, U2354A, U2355A, U2356A, U2331A

Parameter

Item	Type	Range of values	Default value
mode	Discrete	EXTAP SONE	EXTAP

Remarks

Only post-trigger and pre-trigger modes can be used if trigger source is set to **SONE**.

See also

[“TRIGger:SOURce”](#) on page 182

[“TRIGger:ATriGger:CONDition”](#) on page 192

[“TRIGger:ATriGger:HTHReshold”](#) on page 195

[“TRIGger:ATriGger:LTHReshold”](#) on page 197

Example

This example illustrates how the **TRIGger:ATRiGger:SOURce** command is used to select the first scanned channel of the multiplexing DAQ device as the analog input trigger source.

→ ROUT:SCAN (@133,101)	<i>This command sets the instrument to monitor channel 133 and 101.</i>
→ ACQ:SRAT 1000	<i>This command sets the analog input sampling rate to 1 kHz.</i>
→ ACQ:POIN 100	<i>This command sets the instrument to acquire 100 sample points.</i>
→ TRIG:SOUR EXTA	<i>This command sets the external analog trigger as the input triggering source.</i>
→ TRIG:ATRG:SOUR SONE	<i>This command sets the first scanned channel in the instrument scan list as the analog trigger control source.</i>
→ TRIG:ATRG:COND BLOW	<i>This command sets a below-low-level triggering condition.</i>
→ TRIG:ATRG:LTHR 5	<i>This command sets a 5 V low-threshold.</i>
→ TRIG:TYP POST	<i>This command set a post-trigger acquisition for the analog input.</i>
→ DIG	<i>This command starts the single-shot data acquisition process when all trigger conditions are met. If the input signal from channel 133 falls below 5 V, the analog input will be triggered.</i>

TRIGger:ATRiGger:CONDition

Syntax

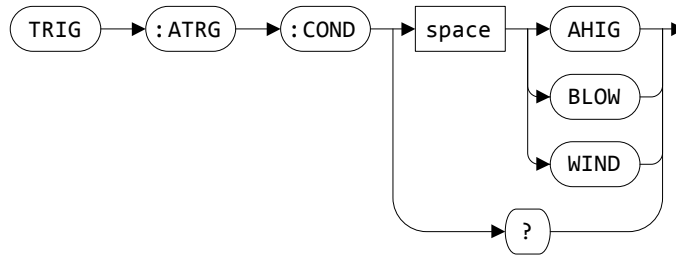
**TRIGger:ATRiGger:CONDition <mode>**

This command is used to set the trigger condition for the AI trigger control.

The valid options are:

- AHIG: Above-High-Level triggering selected. The trigger signal is generated when the analog signal is higher than the high-threshold voltage.
- BLOW: Below-Low-Level triggering selected. The trigger signal is generated when the analog signal is lower than the low-threshold voltage.
- WIND: Window (inside region) triggering selected. The trigger signal is generated when the analog signal falls within the range of the high-threshold and low-threshold voltages.

NOTE

Use the **TRIGger:ATRiGger:LTHReshold** and **TRIGger:ATRiGger:HTHReshold** commands to set the low-threshold and high-threshold voltages.

TRIGger:ATRiGger:CONDition?

This query returns a string value that represents the trigger condition for the AI trigger control.

Supported models

U2351A, U2352A, U2353A, U2354A, U2355A, U2356A, U2331A

Parameter

Item	Type	Range of values	Default value
mode	Discrete	AHIG BLOW WIND	BLOW

See also

[“TRIGger:SOURce”](#) on page 182

[“TRIGger:ATRIgger:SOURce”](#) on page 189

[“TRIGger:ATRIgger:HTHReshold”](#) on page 195

[“TRIGger:ATRIgger:LTHReshold”](#) on page 197

Example

This example illustrates how the **TRIGger:ATriGger:CONDiTion** command is used to select a window triggering condition for the AI trigger control.

→ ROUT:SCAN (@101)	<i>This command sets the instrument to monitor channel 101.</i>
→ ACQ:SRAT 1000	<i>This command sets the analog input sampling rate to 1 kHz.</i>
→ ACQ:POIN 100	<i>This command sets the instrument to acquire 100 sample points.</i>
→ TRIG:SOUR EXTA	<i>This command sets the external analog trigger as the input triggering source.</i>
→ TRIG:ATRG:SOUR EXTAP	<i>This command sets the EXTA_TRIG pin as the analog trigger control source.</i>
→ TRIG:ATRG:COND WIND	<i>This command sets a window triggering condition.</i>
→ TRIG:ATRG:HTHR 5	<i>This command sets a 5 V high-threshold.</i>
→ TRIG:ATRG:LTHR 1	<i>This command sets a 1 V low-threshold.</i>
→ TRIG:TYP POST	<i>This command set a post-trigger acquisition for the analog input.</i>
→ DIG	<i>This command starts the single-shot data acquisition process when all trigger conditions are met. If the input signal from the EXTA_TRIG pin falls between 5 V and 1 V, the analog input will be triggered.</i>

TRIGger:ATRIgger:HTHReshold

Syntax

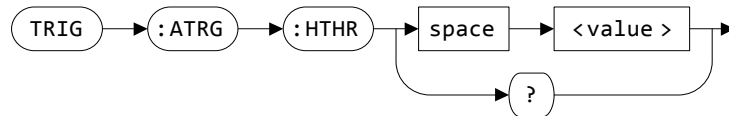

TRIGger:ATRIgger:HTHReshold <value>

This command sets the high-threshold voltage of the AI trigger control.

TRIGger:ATRIgger:HTHReshold?

This query returns a numeric value that represents the high-threshold voltage for the AI trigger control.

Supported models

U2351A, U2352A, U2353A, U2354A, U2355A, U2356A, U2331A

Parameter

Item	Type	Range of values	Default value
value	Numeric	-10 V to 10 V	0 V

Remarks

- If **SONE** mode is selected by **TRIGger:ATRIgger:SOURce** command, the threshold will be limited by the input range configuration of the first channel in the scan list. See **“ROUTE:CHANnel:RANGe”** on page 114 for more information on setting the AI channel input range.
- The high-threshold voltage value must be larger than the low-threshold value.

See also

“TRIGger:SOURce” on page 182

“TRIGger:ATRIgger:SOURce” on page 189

“TRIGger:ATRIgger:CONDition” on page 192

“TRIGger:ATRIgger:LTHReshold” on page 197

Example

This example illustrates how the **TRIGger:ATriGger:HTHReshold** command is used to set a 5 V high-threshold for the AI trigger control.

→ ROUT:SCAN (@101)	<i>This command sets the instrument to monitor channel 101.</i>
→ ACQ:SRAT 1000	<i>This command sets the analog input sampling rate to 1 kHz.</i>
→ ACQ:POIN 100	<i>This command sets the instrument to acquire 100 sample points.</i>
→ TRIG:SOUR EXTA	<i>This command sets the external analog trigger as the input triggering source.</i>
→ TRIG:ATRG:SOUR EXTAP	<i>This command sets the EXTA_TRIG pin as the analog trigger control source.</i>
→ TRIG:ATRG:COND AHIG	<i>This command sets a above-high-level triggering condition.</i>
→ TRIG:ATRG:HTHR 5	<i>This command sets a 5 V high-threshold.</i>
→ TRIG:TYP POST	<i>This command set a post-trigger acquisition for the analog input.</i>
→ DIG	<i>This command starts the single-shot data acquisition process when all trigger conditions are met. If the input signal from the EXTA_TRIG pin rises above 5 V, the analog input will be triggered.</i>

TRIGger:ATRIgger:LTHReshold

Syntax

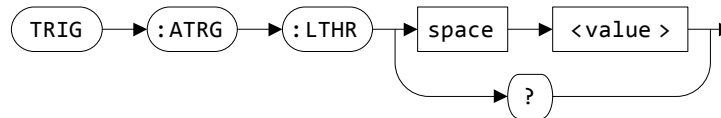

TRIGger:ATRIgger:LTHReshold <value>

This command is used to set the low-threshold voltage of the AI trigger control.

TRIGger:ATRIgger:LTHReshold?

This query returns a numeric value that represents the low-threshold voltage for AI trigger control.

Supported models

U2351A, U2352A, U2353A, U2354A, U2355A, U2356A, U2331A

Parameter

Item	Type	Range of values	Default value
value	Numeric	-10 V to 10 V	0 V

Remarks

- If **SONE** mode is selected by **TRIGger:ATRIgger:SOURce** command, the threshold will be limited by the input range configuration of the first channel in the scan list. See “**ROUTE:CHANnel:RANGe**” on page 114 for more information on setting the AI channel input range.
- The high-threshold voltage value must be larger than the low-threshold value.

See also

“**TRIGger:SOURce**” on page 182

“**TRIGger:ATRIgger:SOURce**” on page 189

“**TRIGger:ATRIgger:CONDition**” on page 192

“**TRIGger:ATRIgger:HTHReshold**” on page 195

Example

This example illustrates how the **TRIGger:ATriGger:LTHReshold** command is used to set a 1 V low-threshold for the AI trigger control.

→ ROUT:SCAN (@101)	<i>This command sets the instrument to monitor channel 101.</i>
→ ACQ:SRAT 1000	<i>This command sets the analog input sampling rate to 1 kHz.</i>
→ ACQ:POIN 100	<i>This command sets the instrument to acquire 100 sample points.</i>
→ TRIG:SOUR EXTA	<i>This command sets the external analog trigger as the input triggering source.</i>
→ TRIG:ATRG:SOUR EXTAP	<i>This command sets the EXTA_TRIG pin as the analog trigger control source.</i>
→ TRIG:ATRG:COND BLOW	<i>This command sets a below-low-level triggering condition.</i>
→ TRIG:ATRG:LTHR 1	<i>This command sets a 1 V low-threshold.</i>
→ TRIG:TYP POST	<i>This command set a post-trigger acquisition for the analog input.</i>
→ DIG	<i>This command starts the single-shot data acquisition process when all trigger conditions are met. If the input signal from the EXTA_TRIG pin falls below 1V, the analog input will be triggered.</i>

TRIGger:DTRiGger:POLarity

Syntax

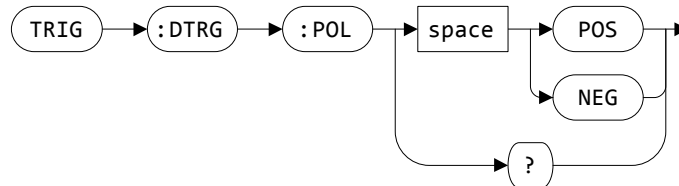

TRIGger:DTRiGger:POLarity <mode>

This command is used to set the polarity of the DIO trigger control.

The valid options are:

- POS (Positive-edge triggering): The trigger signal is generated when a rising edge is detected in the digital signal.
- NEG (Negative-edge triggering): The trigger signal is generated when a falling edge is detected in the digital signal.

TRIGger:DTRiGger:POLarity?

This query returns a string value that represents the polarity selected for the DIO trigger control.

Supported models

U2351A, U2352A, U2353A, U2354A, U2355A, U2356A, U2331A

Parameter

Item	Type	Range of values	Default value
mode	Discrete	POS NEG	POS

See also

[“TRIGger:SOURce”](#) on page 182

[“TRIGger:TYPe”](#) on page 184

Example

This example illustrates how the **TRIGger:DTRiGger:POLarity** command is used to select a negative-edge trigger condition for the DIO trigger control.

→ ROUT:SCAN (@101)	<i>This command sets the instrument to monitor channel 101.</i>
→ ACQ:SRAT 1000	<i>This command sets the analog input sampling rate to 1 kHz.</i>
→ ACQ:POIN 100	<i>This command sets the instrument to acquire 100 sample points.</i>
→ TRIG:SOUR EXT	<i>This command sets the EXT_AO_TRIGGER pin as the input triggering source.</i>
→ TRIG:DTRG:POL NEG	<i>This command sets a negative-edge trigger condition for the digital trigger source.</i>
→ TRIG:TYP POST	<i>This command set a post-trigger acquisition for the analog input.</i>
→ DIG	<i>This command starts the single-shot data acquisition process when a negative-edge digital signal is received from the EXT_AO_TRIGGER pin.</i>

13 WAVEform Subsystem

WAVEform:DATA?	202
WAVEform:POINts	204
WAVEform:STATus?	207
WAVEform:COMPLete?	209

This chapter describes the WAVEform commands used to program the U2300A Series DAQ device over a remote interface. Use the WAVEform:DATA? query to return the raw data acquired by the input channels. You can also set the acquisition count for the continuous acquisition process.

WAVeform:DATA?

Syntax



WAVeform:DATA?

This command is used to return the raw data from all the AI channels in the scan list (as defined by the **ROUTE:SCAN** command). The values are returned in the IEEE-488.2 binary block format. See [“Using the IEEE-488.2 binary block format”](#) on page 221 for more information.

As an example, a returned value of **#800000200<byte1><byte2>...<byte199><byte200>** indicates that there is a total of 200 bytes of returned data. Each acquisition point is made up of two bytes. The first byte is the least-significant bit (LSB) and the second byte is the most-significant bit (MSB).

The example above returns a total of 100 acquisition points.

Supported models

U2351A, U2352A, U2353A, U2354A, U2355A, U2356A, U2331A

Remarks

- A maximum of 8 Msa is returned for the single-shot acquisition process and 4 Msa for the continuous acquisition process.
- The length of the header returned is fixed at 10 characters (this includes the characters “#” and “8”).

See also

[“ACQUIRE:SRATE”](#) on page 30

[“ACQUIRE:POINTS”](#) on page 33

[“ROUTE:SCAN”](#) on page 112

[“WAVEFORM:POINTS”](#) on page 204

[“DIGITIZE”](#) on page 212

[“RUN”](#) on page 214

[“STOP”](#) on page 216

Example

This example illustrates how the **WAVeform:DATA?** query is used to return 1000 sample points of raw data per data block from the instrument buffer.

→ ROUT:SCAN (@101)	<i>This command sets the instrument to monitor channel 101.</i>
→ ACQ:SRAT 1000	<i>This command sets the analog input sampling rate to 1 kHz.</i>
→ WAV:POIN 1000	<i>This command sets the instrument to acquire 1000 sample points per data block.</i>
→ RUN	<i>This command starts the continuous data acquisition process.</i>
→ WAV:STAT?	<i>This query returns the acquisition status of the instrument buffer.</i>
← DATA	<i>The returned value is DATA, indicating that at least one block of data is completed and ready to be read back.</i>
→ WAV:DATA?	<i>This query returns one block of raw data from AI channel 101.</i>
← #800002000<byte1> <byte2>...<byte2000>	<i>The first block of data is returned.</i>
→ WAV:DATA?	
← #800002000<byte1> <byte2>...<byte2000>	<i>The second block of data is returned.</i>
→ STOP	<i>This command stops the continuous data acquisition process.</i>

WAVeform:POINTs

Syntax

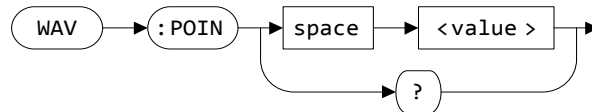

WAVeform:POINTs <value>

This command is used to set the number of acquisition points for the continuous acquisition process. Each acquisition point is made up of two bytes. Hence, setting the acquisition points to 100 implies that a block of 200 bytes of raw data is transferred to the PC when the **WAVeform:DATA?** query is issued.

WAVeform:POINTs?

This query returns a numeric value that represents the number of acquisition points set for the continuous acquisition process.

NOTE

The continuous acquisition process is initiated by the RUN command. Use the STOP command to stop the continuous acquisition process.

Supported models

U2351A, U2352A, U2353A, U2354A, U2355A, U2356A, U2331A

Parameter

Item	Type	Range of values	Default value
value	Numeric	Maximum of 4 Msa	500

Remarks

This command performs the same functions as the **ACQuire:POINts** command. The only difference is that the **ACQuire:POINts** command is used for single-shot acquisitions, while the **WAVeform:POINts** command is used for continuous acquisitions.

See also

[“ACQuire:SRATe”](#) on page 30

[“ACQuire:POINts”](#) on page 33

[“ROUTe:SCAN”](#) on page 112

[“WAVeform:DATA?”](#) on page 202

[“RUN”](#) on page 214

[“STOP”](#) on page 216

Example

This example illustrates how the **WAVEform:POINTs** command is used to acquire 10 sample points of raw data per data block from AI channel 101 and 102.

→ ROUT:SCAN (@101,102)	<i>This command sets the instrument to monitor channel 101 and 102.</i>
→ ACQ:SRAT 1000	<i>This command sets the analog input sampling rate to 1 kHz.</i>
→ WAV:POIN 10	<i>This command sets the instrument to acquire 10 sample points per data block.</i>
→ RUN	<i>This command starts the continuous acquisition process.</i>
→ WAV:STAT?	<i>This query returns the acquisition status of the instrument buffer.</i>
← DATA	<i>The returned value is DATA, indicating that at least one block of data is completed and ready to be read back.</i>
→ WAV:DATA?	<i>This query returns one block of raw data from both AI channel 101 and channel 102 respectively.</i>
← #800000040<byte1> <byte2>...<byte40>	<i>The first block of data is returned.</i>
→ WAV:DATA?	
← #800000040<byte1> <byte2>...<byte40>	<i>The second block of data is returned.</i>
→ STOP	<i>This command stops the continuous acquisition process.</i>

WAVeform:STATus?

Syntax



WAVeform:STATus?

This query returns a string value that represents the acquisition status of the instrument buffer.

- EPTY: Empty, indicates that there is no data captured.
- FRAG: Fragment, indicates that the instrument has started to acquire data, but has yet to complete a single block of data.
- DATA: Indicates that at least one block of data is completed and ready to be read back.
- OVER: Indicates that the buffer is full and the acquisition is stopped.

Supported models

U2351A, U2352A, U2353A, U2354A, U2355A, U2356A, U2331A

Example

This example illustrates how the **WAVEform:STATus?** query is used to return the acquisition status of the instrument.

→ ROUT:SCAN (@101:103)	<i>This command sets the instrument to monitor channel 101, 102, and 103.</i>
→ ACQ:SRAT 1000	<i>This command sets the analog input sampling rate to 1 kHz.</i>
→ WAV:POIN 1000	<i>This command sets the instrument to acquire 1000 sample points per data block.</i>
→ WAV:STAT?	<i>This query returns the acquisition status of the instrument buffer.</i>
← EPTY	<i>The returned value is EPTY, indicating that there is no data captured at the moment.</i>
→ RUN	<i>This command starts the continuous acquisition process.</i>
→ WAV:STAT?	
← FRAG	<i>The returned value is FRAG, indicating that the acquisition process has begun, but has yet to complete a single data block.</i>
→ WAV:STAT?	
← DATA	<i>The returned value is DATA, indicating that at least one block of data is completed and ready to be read back.</i>
→ WAV:DATA?	<i>This query returns the completed block of raw data from all three AI channels (101, 102, and 103).</i>
← #800006000<byte1> <byte2>...<byte6000>	<i>The first completed block of data is returned.</i>
→ STOP	<i>This command stops the continuous acquisition process.</i>

WAVeform:COMPLete?

Syntax



WAVeform:COMPLete?

This query returns a string value that represents the current acquisition status of the instrument.

- YES: Indicates that the acquisition process has been completed (for single-shot acquisition) or stopped.
- NO: Indicates that the instrument is still capturing data.

Supported models

U2351A, U2352A, U2353A, U2354A, U2355A, U2356A, U2331A

Example

This example illustrates how the **WAVEform:STATUS?** query is used to return the acquisition status of the instrument.

→ ROUT:SCAN (@101)	<i>This command sets the instrument to monitor channel 101.</i>
→ ACQ:SRAT 1000	<i>This command sets the analog input sampling rate to 1 kHz.</i>
→ ACQ:POIN 1000	<i>This command sets the instrument to acquire 1000 sample points..</i>
→ DIG	<i>This command starts the single-shot acquisition process.</i>
→ WAV:COMP?	<i>This query returns the acquisition status of the instrument.</i>
← NO	<i>The returned value is NO, indicating that the data is still being captured.</i>
→ WAV:COMP?	
→ YES	<i>The returned value is YES, indicating that the single-shot acquisition process has completed.</i>
→ WAV:DATA?	<i>This query returns the raw data acquired from AI channel 101.</i>
← #800002000<byte1> <byte2>...<byte2000>	<i>The acquired data block is returned.</i>

14 Root Commands

DIGitize	212
RUN	214
STOP	216
MODEl?	217
SERial?	218
DATA[:USER]	219

This chapter describes the root commands used to program the U2300A Series DAQ device over a remote interface. Use the RUN/DIG command to start a single-shot or continuous acquisition process. You can also send a block of data in the instrument FIFO buffer for AO operations.

DIGitize

Syntax

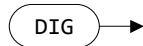

DIGitize

This command is used to start the single-shot data acquisition process. In single-shot acquisition, a specified number of sample points is acquired and the data is processed once. Use the **ACQUIRE:POINTS** command to specify the number of sample points to be acquired.

Supported models

U2351A, U2352A, U2353A, U2354A, U2355A, U2356A, U2331A

Remarks

Use the **STOP** command to stop the single-shot acquisition process before the number of points specified in **ACQUIRE:POINTS** is reached.

See also

[“ACQUIRE:SRATE”](#) on page 30

[“ACQUIRE:POINTS”](#) on page 33

[“WAVEFORM:DATA?”](#) on page 202

[“WAVEFORM:COMPLETE?”](#) on page 209

[“STOP”](#) on page 216

Example

This example illustrates how the **DIG** command is used to acquire 1000 sample points of raw data from AI channel 101.

→ ROUT:SCAN (@101)	<i>This command sets the instrument to monitor channel 101.</i>
→ ACQ:SRAT 1000	<i>This command sets the analog input sampling rate to 1 kHz.</i>
→ ACQ:POIN 1000	<i>This command sets the instrument to acquire 1000 sample points..</i>
→ DIG	<i>This command starts the single-shot acquisition process.</i>
→ WAV:COMP?	<i>This query returns the acquisition status of the instrument.</i>
← NO	<i>The returned value is NO, indicating that the data is still being captured.</i>
→ WAV:COMP?	
→ YES	<i>The returned value is YES, indicating that the single-shot acquisition process has completed.</i>
→ WAV:DATA?	<i>This query returns the raw data acquired from AI channel 101.</i>
← #800002000<byte1> <byte2>...<byte1000>	<i>The acquired data block is returned.</i>

RUN

Syntax

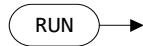

RUN

This command is used to start the continuous data acquisition process. In continuous acquisition, data is continuously acquired until a **STOP** command is sent. Use the **WAVEform:POINTs** command to specify the number of sample points to be acquired in a single block of data.

Supported models

U2351A, U2352A, U2353A, U2354A, U2355A, U2356A, U2331A

Remarks

Use the **STOP** command to terminate the continuous acquisition process.

See also

[“ACQUIRE:SRATE”](#) on page 30

[“WAVEform:POINTs”](#) on page 204

[“WAVEform:DATA?”](#) on page 202

[“WAVEform:STATus?”](#) on page 207

[“STOP”](#) on page 216

Example

This example illustrates how the **RUN** command is used to continuously acquire 200 sample points of raw data per block from AI channel 101 until the **STOP** command is used.

→ ROUT:SCAN (@101)	<i>This command sets the instrument to monitor channel 101.</i>
→ WAV:POIN 200	<i>This command sets 200 sample points to be acquired.</i>
→ ACQ:SRAT 1000	<i>This command sets the analog input sampling rate to 1 kHz.</i>
→ WAV:STAT?	<i>This query returns the acquisition status of the instrument.</i>
← EPTY	<i>The returned value is EPTY, indicating that no data have been captured.</i>
→ RUN	<i>This command starts the continuous data acquisition process.</i>
→ WAV:STAT?	
← DATA	<i>The returned value is DATA, indicating that at least a block of data is completed and ready to be read back.</i>
→ STOP	<i>This command stops the continuous data acquisition process.</i>
→ WAV:DATA?	<i>This query returns the raw data of the AI channels that are enabled by the ROUTe:SCAN command.</i>
← #800003990<byte1> <byte2>...<byte3990>	<i>The total acquired data is returned.</i>

STOP

Syntax



STOP

This command is used to stop the asynchronous analog input operation. Use this command to terminate the continuous acquisition process (initiated by the **RUN** command) or to prematurely stop the single-shot acquisition process (initiated by the **DIG** command).

Example

This example illustrates how the **STOP** command is used to stop the continuous acquisition process from capturing anymore data.

→ ROUT:SCAN (@101)	<i>This command sets the instrument to monitor channel 101.</i>
→ WAV:POIN 200	<i>This command sets 200 sample points to be acquired.</i>
→ ACQ:SRAT 1000	<i>This command sets the analog input sampling rate to 1 kHz.</i>
→ RUN	<i>This command starts the continuous data acquisition process.</i>
→ WAV:COMP?	<i>This query returns the current acquisition status of the continuous acquisition process.</i>
← NO	<i>The returned value is NO, indicating that data is still being captured.</i>
→ STOP	<i>This command stops the continuous data acquisition process.</i>
→ WAV:COMP?	
← YES	<i>The returned value is YES, indicating that the continuous acquisition process has completed.</i>

MODe1?

Syntax



MODe1?

This query returns a string value that represents the model of the connected DAQ device. The returned string can be any of the supported models in the U2300A Series USB multifunction data acquisition devices family.

Supported models

U2351A, U2352A, U2353A, U2354A, U2355A, U2356A, U2331A

Example

→ MOD?

This query returns the model of the connected DAQ device

← U2355A

SERial?

Syntax

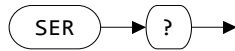

SERial?

This query returns a string value that represents the serial number of the connected DAQ device.

Supported models

U2351A, U2352A, U2353A, U2354A, U2355A, U2356A, U2331A

Example

```
→ SER? This query returns the serial number of the  
connected DAQ device  
← TW47222003
```

DATA[:USER]

Syntax

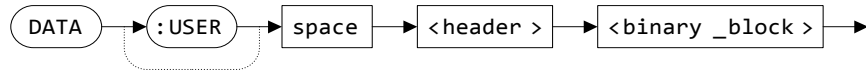

DATA[:USER] <header><binary_block>

This command is used to set a user-defined pattern onto the instrument FIFO buffer. At least 4 bytes (2 waveform points) of data per channel is required for AO function. If both AO channels are enabled, then a minimum length of 8 bytes (4 waveform points) is necessary.

Supported models

U2352A, U2354A, U2355A, U2356A, U2331A

Remarks

- The **<header>** and **<binary_block>** value must be sent in the IEEE-488.2 binary block format. See [“Using the IEEE-488.2 binary block format”](#) on page 221 for more information.
- This command cannot be executed while the analog output is enabled (initiated by the **OUTPUT ON** command).
- This is an adjunct command for the **APPLY:USER** command.

See also

[“APPLY:USER”](#) on page 51

[“OUTPUT”](#) on page 84

[“OUTPUT:WAVEform:SRATE”](#) on page 88

Example

This example illustrates how the **DATA[:USER]** command is used with the **APPLY:USER** command to output an arbitrary waveform via channel 201.

- **ROUT:ENAB ON, (@201)** *This command enables output operations for channel 201.*
- **OUTP:WAV:ITER 0** *This command causes the instrument to generate the waveform indefinitely.*
- **OUTP:WAV:SRAT 2000** *This command sets the analog output waveform sampling rate to 2 kHz.*
- **DATA** *This command sets a user defined pattern to the instrument buffer.*
#800002000cb0fc50fc30f
c20fc30fcb1f...
<byte2000>
- **APPL:USER (@201)** *This command sends the user-defined pattern to channel 201.*
- **OUTP ON** *This command generates the user-defined pattern from channel 201.*

Using the IEEE-488.2 binary block format

In the binary block format, a block header precedes the waveform data. The block header has the following format:

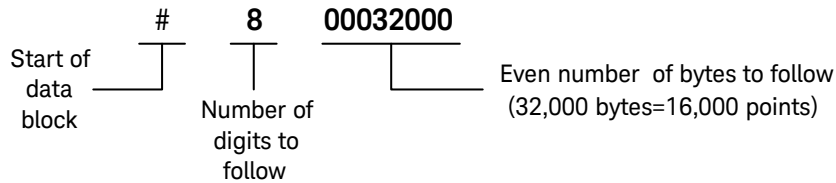

The DAQ device represents binary data as 12-bit (U2331A) or 16-bit (U2351A/52A/53A/54A/55A/56A) integers, which is sent as two bytes. Therefore, the total number of bytes is always twice the number of data points in the waveform (and must always be an even number). Any number of data that is not divisible by two will be truncated. In other words if you input 5-bytes of data, only 4-bytes will be retained.

For example, 32,000 bytes are required to download a waveform with 16,000 points. The least-significant byte (LSB) of each data point is sent first in the byte order for binary transfers in block mode.

The length of the block header is fixed in the U2300A Series DAQ device – 10 characters (including the start of data block character “#” and the number of digits to follow character “8”), 20 bytes in size.

NOTE

For more information on the binary block format and the raw data conversion, see “A/D data conversion” in the *Keysight U2300A Series USB Multifunction Data Acquisition Devices User’s Guide*.

THIS PAGE HAS BEEN INTENTIONALLY LEFT BLANK.

15 IEEE-488.2 Common Commands

*CLS	224
*ESE	225
*ESR?	227
*IDN?	228
*OPC	229
*RCL	230
*RST	232
*SAV	233
*SRE	234
*STB?	236
*TST?	237
*WAI	238

This chapter gives an introduction to the IEEE-488.2 common commands. It defines a set of common commands that perform functions such as reset, self-test, and status operations.

*CLS

Syntax



*CLS

The *CLS (Clear Status) is used to clear the event registers in all register groups. This command also clears the error queue.

Supported models

U2351A, U2352A, U2353A, U2354A, U2355A, U2356A, U2331A

Example

→ *CLS

This command clears the event register bits and the error queue.

*ESE

Syntax

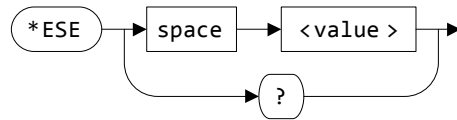

*ESE <value>

The ***ESE** (Event Status Enable) enables bits in the enable register for the Standard Event register group. The selected bits are then reported to bit 5 of the Status Byte register.

Table 15-1 Standard Event register mapping

Bit number	Decimal value	Meaning
0	1	Operation complete
1	Not used	Not used
2	4	Query error
3	8	Device error
4	16	Execution error
5	32	Command error
6	Not used	Not used
7	128	Power-on

*ESE?

This query reads the enable register and returns a decimal value that corresponds to the binary-weighted sum of all bits set in the register. For example, if bit 3 (decimal value = 8) and bit 7 (decimal value = 128) are enabled, this query returns “+136”.

NOTE

For more information on the bit definitions of the Standard Event register and the SCPI status diagram, see “[SCPI Status System](#)” on page 25.

Supported models

U2351A, U2352A, U2353A, U2354A, U2355A, U2356A, U2331A

Parameter

Item	Type	Range of values	Default value
value	Numeric	0 to 255 ^[a]	0

[a] Refer to [Table 15-1](#) for the list of bit definitions for the Standard Event register. To enable more than one bit at a time, use the binary-weighted sum of the intended bits. For example, to set bit 2, 3, and 4, use **28** (4 + 8 + 16) as your value.

Remarks

- An enable register defines which bits in the event register is reported to the Status Byte register group. You can write to or read from an enable register.
- The ***CLS** (clear status) command will not clear the enable register but it will clear all bits in the event register.
- Refer to [Figure 1-2](#) on page 26 for the status system diagram.

See also

[“*CLS”](#) on page 224

[“*ESR?”](#) on page 227

Example

→ ***ESE 16**

This command enables bit 4 (decimal value = 16) in the enable register. If an execution error occurs, this condition will be reported to the Status Byte register (bit 5 will be set to high).

→ ***ESE?**

This query returns which bits are enabled in the register.

← **+16**

*ESR?

Syntax



*ESR?

The ***ESR?** (Event Status Register) query reads the event register for the Standard Event register group and returns a decimal value which corresponds to the binary-weighted sum of all bits set in the event register (Table 15-1 on page 225). For example, if bit 0 (decimal value = 1) and bit 4 (decimal value = 16) are set (and the corresponding bits are enabled), this query returns the decimal value “+17”.

Supported models

U2351A, U2352A, U2353A, U2354A, U2355A, U2356A, U2331A

Remarks

- An event register latches the various events from the condition register. There is no buffering in this register; while an event bit is set, subsequent events corresponding to that bit are ignored. This is a read-only register.
- The ***CLS** (clear status) command clears all bits in the event register.
- In order to be reported to the Standard Event register, the corresponding bits in the event register must be enabled using the ***ESE** command.
- Refer to Figure 1-2 on page 26 for the status system diagram.

See also

“***CLS**” on page 224

“***ESE**” on page 225

Example

→ *ESR?

This command reads the event register (bits 3 and 4 are set).

← +24

*IDN?

Syntax

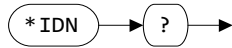

*IDN?

The `*IDN?` (IDeNtify) query returns the instrument identification string which contains four comma-separated fields. The first field returned is the manufacturer name, followed by the instrument model number, serial number, and firmware revision code.

`<Manufacturer>`, `<Model_no>`, `<Serial_no>`, `<A.YYYY.MM.DD>`

Where, **YYYY** represents the year, **MM** represents the month, and **DD** represents the date of the firmware release.

Supported models

U2351A, U2352A, U2353A, U2354A, U2355A, U2356A, U2331A

Example

→ `*IDN?`

This query returns the instrument identification string.

← `Keysight Technologies,`
`U2331A,TW12345678,`
`A.2008.11.04`

*OPC

Syntax



*OPC

The ***OPC** (Operation Complete) command sets the “Operation complete” bit (bit 0) in the Standard Event register at the completion of the current operation.

*OPC?

This query returns the value “+1” to the output buffer at the completion of the current operation.

NOTE

For more information on the bit definitions of the Standard Event register and the SCPI status diagram, see “[SCPI Status System](#)” on page 25.

Supported models

U2351A, U2352A, U2353A, U2354A, U2355A, U2356A, U2331A

Remarks

- The purpose of this command is to synchronize your application with the instrument.
- Note the difference between the ***OPC** command and the ***OPC?** query. The latter returns “**1**” to the output buffer at the completion of the current operation.

Example

→ *OPC?

This query returns the value “+1” to the output buffer at the completion of the current operation.

← 1

*RCL

Syntax

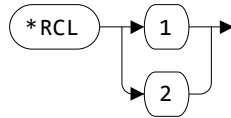

***RCL {1|2}**

This ***RCL** (ReCaLL) command recalls the instrument state stored in the specified storage location. It is not possible to recall the instrument state from a storage location that is empty. When shipped from the factory, storage locations 1 and 2 are empty.

Use the ***SAV** command to store the current instrument state.

Supported models

U2351A, U2352A, U2353A, U2354A, U2355A, U2356A, U2331A

Parameter

Item	Type	Range of values	Default value
state	Discrete	1 2	-

Remarks

- The U2300A Series DAQ devices have two storage locations in the nonvolatile memory to store instrument states. You can only recall a state from a location that contains a previously stored state.
- Before recalling a stored state, the DAQ device performs the equivalent of a factory reset (***RST** command).
- A Factory Reset (***RST** command) does not affect the configurations stored in the memory. Once a state is stored, it remains until it is overwritten.

See also

***SAV** on page 233

***RST** on page 232

Example

→ ***RCL 1**

This command recalls the instrument state previously stored in location 1.

*RST

Syntax



*RST

The ***RST** (ReSeT) command resets the DAQ device to its factory default state, which is the state when the DAQ device is powered-on for the first time.

NOTE

Refer to **Chapter 17, “Factory Default Settings”** on page 249 for a complete listing of the U2300A Series DAQ device default settings.

Remarks

- The ***RST** command does not clear the event registers and the error queue. To clear the event registers and the error queue, send the ***CLS** command.
- This command does not affect any previously stored instrument states. For more information on saving and recalling previously stored instrument states, see ***SAV** on page 233 and ***RCL** on page 230.

See also

***CLS** on page 224

***RCL** on page 230

***SAV** on page 233

Example

→ ***RST**

This command resets the instrument to its factory default state.

*SAV

Syntax

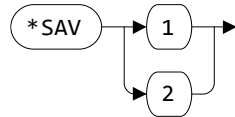

*SAV {1|2}

The ***SAV** (SAVe) command stores (saves) the current instrument state in the designated storage location. Any state previously stored in the same location is overwritten (with no error generated).

Use the ***RCL** command to recall a stored instrument state.

Parameter

Item	Type	Range of values	Default value
state	Discrete	1 2	-

Remarks

- The U2300A Series DAQ devices have two storage locations in nonvolatile memory to store instrument states. You can store the instrument state in any one of the two locations, but you can only recall a state from a location that contains a previously stored state.
- A Factory Reset (***RST** command) command does not affect the configurations stored in the memory. Once a state is stored, it remains until it is overwritten.

See also

***RCL** on page 230

***RST** on page 232

Example

→ ***SAV 1**

This command stores the current instrument state in location 1.

*SRE

Syntax

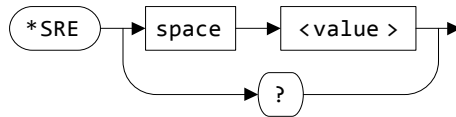

*SRE <value>

The ***SRE** (Service Request Enable) command enables bits in the enable register for the Status Byte register group. Once enabled, the corresponding bits may generate a Request for Service (RQS) in the Status Byte. This RQS event may generate a “call back” to your application as a type of asynchronous interrupt.

Table 15-2 Status Byte register mapping

Bit number	Decimal value	Definition
0	Not used	Not used
1	Not used	Not used
2	4	Error queue
3	Not used	Not used
4	16	Message available
5	32	Standard Event summary
6	64	Master Status summary
7	Not used	Not used

*SRE?

This command reads the enable register and returns a decimal value which corresponds to the binary-weighted sum of all bits set in the register. For example, if bit 2 (decimal value = 4) and bit 4 (decimal value = 16) are enabled, the query returns “+20”.

NOTE

For more information on the bit definitions of the Status Byte register and the SCPI status diagram, see “[SCPI Status System](#)” on page 25.

Parameter

Item	Type	Range of values	Default value
value	Numeric	0 to 255 ^[a]	0

[a] Refer to [Table 15-2](#) for the list of bit definitions for the Status Byte register. To enable more than one bit at a time, use the binary-weighted sum of the intended bits. For example, to set bit 2, 4, and 5, use **52** (4 + 16 + 32) as your value.

Remarks

- An enable register defines which bits in the event register is reported to the Status Byte register group. You can write to or read from an enable register.
- The ***CLS** (clear status) command will not clear the enable register but it does clear all bits in the event register.
- A ***CLS** or ***RST** command does not clear the bits in the Status Byte enable register.
- Refer to [Figure 1-2](#) on page 26 for the status system diagram.

See also

“[*STB?](#)” on page 236

Example

```
→ *SRE 16           This command enables bit 4 (decimal value = 16)
                    in the enable register.
→ *SRE?            This query returns which bits are enabled in the
                    register.
← 16
```

*STB?

Syntax

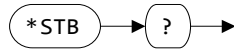

The ***STB?** (S**T**atus **B**yte) query returns the condition register for the Status Byte register group. This command is similar to a Serial Poll but it is processed like any other instrument command.

NOTE

This is a read-only register and the bits are not cleared when you read the register. For more information on the bit definitions of the Status Byte register and the SCPI status diagram, see **“SCPI Status System”** on page 25.

Remarks

- A condition register continuously monitors the state of the instrument. The bits in the condition register are updated in real time and the bits are not latched or buffered.
- This query returns the same results as a Serial Poll but the “Master Status summary” bit (bit 6) is not cleared if a Serial Poll has occurred.
- A Factory Reset (***RST** command) or power-on cycle clears all bits in the condition register.
- Refer to **Figure 1-2** on page 26 for the status system diagram.

See also

“*RST” on page 232

“*SRE” on page 234

Example

→ ***STB?**

This command reads the condition register (bits 3 and 5 are set).

← **+40**

*TST?

Syntax

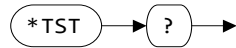

*TST?

The ***TST?** (TeST) query performs a self-test of the instrument and returns a pass/fail indication. The self-test runs a series of tests and will take a few seconds to complete. If all tests pass, you can have a high confidence that the instrument is operational. The query returns “+0” (all tests passed) or “+1” (one or more tests failed).

Remarks

- If one or more tests fail, “+1” is returned and an error is stored in the error queue. For a complete listing of the error messages related to self-test failures, see [Chapter 16, “Error Messages”](#) on page 239.
- If one or more tests fail, see the *Keysight U2300A Series USB Multifunction Data Acquisition Devices Service Guide* for instructions on obtaining service.
- Following the ***TST?** query, the instrument issues a Factory Reset (***RST** command).

See also

“***RST**” on page 232

Example

→ *TST?

This command begins the self-test process and returns a pass/fail indication.

← +0

The returned value “+0” indicates that the instrument has passed all tests performed.

*WAI

Syntax



*WAI

The ***WAI** (WAI) command configures the instrument output buffer to wait until:

- all pending operations are complete,
- the device clear command is received, or
- power is cycled,

before executing any subsequent commands or queries.

Example

→ ***WAI**

This command waits until all pending operations complete.

16 Error Messages

Error Messages [240](#)

The U2300A Series DAQ device SCPI command errors are summarized in this chapter.

Error Messages

Error messages are created once an erroneous condition is detected.

Errors are retrieved in first-in-first-out (FIFO) order using the **SYSTem:ERRor?** query. The first error returned is the first error that was stored. Reading this error will clear this error allowing the next stored error to be read (if there are other errors stored). Once you have read all of the interface-specific errors, the errors in the global error queue will be retrieved.

If more than 10 errors have occurred, the last error stored in the queue (the most recent error) is replaced with error number: **-350, "Queue overflow"**. No additional errors are stored until you remove the previously stored errors from the queue.

If no errors have occurred when you read the error queue, the instrument responds with the message: **+0, "No error"**.

The interface-specific and global error queues are cleared by the clear status (***CLS**) command and when the instrument power is cycled. The error queue will not be cleared by a factory reset (***RST**) command.

See also

***CLS** on page 224

***RST** on page 232

SYSTem:ERRor? on page 179

SCPI command errors

The following table shows the list of SCPI command errors.

Table 16-1 List of SCPI command errors

Error number	Description
+0	No error This is the response to the <code>SYSTem:ERROr?</code> query when there are no errors.
-100	Command error Generic syntax error.
-101	Invalid character An invalid character was found in the command string. You may have inserted a character such as #, \$, or % in a command keyword or within a parameter.
-102	Syntax error Invalid syntax was found in the command string. You may have inserted a blank space before or after a colon in the command header, or before a comma.
-103	Invalid separator An invalid separator was found in the command string. Check for proper usage of , ; :
-104	Data type error The wrong parameter type was found in the command string. You may have specified a number where a string was expected, or vice versa.
-108	Parameter not allowed More parameters were received than were expected for the command. You may have entered an extra parameter or added a parameter to a command that does not require a parameter.
-109	Missing parameter Fewer parameters were received than were expected for this command. You have omitted one or more parameters that are required for this command.
-110	Command header error An error was detected in the header.
-111	Header separator error A character that was not a valid header separator was found in the command string.
-112	Program mnemonic too long The header contains more than 12 characters.

Table 16-1 List of SCPI command errors (continued)

Error number	Description
-113	<p>Undefined header</p> <p>A command was received that is not valid. You may have misspelled the command or it may not be a valid command. If you are using the short form of the command, remember that it may contain up to four letters.</p>
-114	<p>Header suffix out of range</p> <p>The value of the numeric suffix is not valid.</p>
-120	<p>Numeric data error</p> <p>Generic numeric data error.</p>
-121	<p>Invalid character in number</p> <p>An invalid character was found in the number specified for a parameter value.</p>
-123	<p>Exponent too large</p> <p>A numeric parameter was found where its exponent was larger than 32759.</p>
-124	<p>Too many digits</p> <p>The mantissa of a numeric parameter contained more than 255 digits, excluding leading zeros.</p>
-128	<p>Numeric data not allowed</p> <p>A numeric parameter was received but a character string was expected.</p>
-130	<p>Suffix error</p> <p>Generic suffix error.</p>
-131	<p>Invalid suffix</p> <p>A suffix was incorrectly specified for a numeric parameter.</p>
-134	<p>Suffix too long</p> <p>The suffix contains more than 12 characters.</p>
-138	<p>Suffix not allowed</p> <p>A suffix is not supported for this command.</p>
-140	<p>Character data error</p> <p>Generic character data error.</p>
-141	<p>Invalid character data</p> <p>Either the character data element contains an invalid character, or the element is not valid.</p>
-144	<p>Character data too long</p> <p>The character data element contains more than 12 characters.</p>

Table 16-1 List of SCPI command errors (continued)

Error number	Description
-148	Character data not allowed A discrete parameter was received, but a string or numeric parameter was expected.
-150	String data error Generic string data error.
-151	Invalid string data An invalid character string was received. Check that the string is enclosed in quotation marks.
-158	String data not allowed A character string was received, but is not allowed for this command.
-160	Block data error Generic block data error.
-161	Invalid block data The number of data bytes sent does not match the number of bytes specified in the header.
-168	Block data not allowed Data was sent in the arbitrary block format but is not allowed for this command.

SCPI execution errors

The following table shows the list of SCPI execution errors.

Table 16-2 List of SCPI execution errors

Error number	Description
-200	Execution error Generic syntax error.
-220	Parameter error A data element related error occurred.
-221	Settings conflict A data element could not be executed because of the present instrument state.
-221	Settings conflict The amplitude and offset are out of the reference voltage range.
-221	Settings conflict The high threshold is lower than low threshold.
-221	Settings conflict The analog trigger level is beyond range because of the analog trigger source.
-221	Settings conflict The sampling rate is beyond range because of the number of channels.
-221	Settings conflict The acquisition points is beyond range because of the number of channels.
-221	Settings conflict The waveform points is beyond range because of the number of channels.
-221	Settings conflict Unsupported trigger mode.
-221	Settings conflict Unsupported trigger mode because of the analog trigger source.
-222	Data out of range External clock is set above instrument's capability.

Table 16-2 List of SCPI execution errors (continued)

Error number	Description
-223	Too much data An Arbitrary waveform was specified that contains more than 65536 waveform points.
-224	Illegal parameter value An exact value was expected or an invalid discrete parameter was received.

SCPI device-specific errors

The following table shows the list of SCPI device-specific errors.

Table 16-3 List of SCPI device-specific errors

Error number	Description
-300	Device specific error A device-specific error not defined in greater detail has occurred.
-310	System error The U2300A operation has not completed properly, possibly due to an abnormal hardware or firmware condition.
-311	Memory error A memory error not defined in greater detail has occurred. This error indicates some physical fault in the device memory, such as a parity error.
-313	Calibration memory lost The nonvolatile memory used to store the U2300A calibration constants has detected a checksum error which may be caused by a device failure or extreme conditions such as lightning or strong magnetic fields.
-314	Save/recall memory lost This error indicates that the nonvolatile data saved by the *SAV command has been lost.
-315x	Save/recall memory lost This error indicates that the nonvolatile configuration data saved by the device has been lost.
-321	Out of memory The storage space available in the instrument is exhausted.

Table 16-3 List of SCPI device-specific errors (continued)

Error number	Description
-330	Self-test failed The U2300A Series DAQ device complete self-test failed from the remote interface (*TST? command). This indicates a problem with the device that is not covered by a specific error message. The device may require service.
-350	Queue overflow The error queue is full because more than 20 errors have occurred. No additional errors are stored until you remove the errors from the queue.

SCPI query errors

The following table shows the list of SCPI query errors.

Table 16-4 List of SCPI query errors

Error number	Description
-400	Query error Generic error query.
-410	Query INTERRUPTED A condition causing an interrupted query error occurred.
-420	Query UNTERMINATED A condition causing an unterminated query error occurred.
-430	Query DEADLOCKED A condition causing a deadlocked query error occurred.
-440	Query UNTERMINATED after indefinite response A query was received in the same program message after a query indicating an indefinite response was executed.

SCPI instrument errors

The following table shows the list of SCPI instrument errors.

Table 16-5 List of SCPI instrument errors

Error number	Description
112	Channel list: channel number out of range
113	Channel list: empty scan list
222	Settings conflict: module type does not match state
223	Settings conflict: trig source changed to IMM
261	Not able to execute while scan initiated
262	Not able to abort scan
263	Not able to execute while instrument is measuring
264	Not a scannable channel
281	Not able to perform on more than one channel
301	Module currently committed to scan
303	Module is not able to perform requested operation
304	Does not exist
305	Not able to perform requested operation
305	Not able to perform requested operation; cannot generate user-defined and pre-defined waveforms at once
305	Not able to perform requested operation; output is running
305	Not able to perform requested operation; output has stopped
305	Not able to perform requested operation; function must be enabled first
305	Not able to perform requested operation; user-defined waveform not set
305	Not able to perform requested operation; sampling rate cannot be 0 with user-defined output
307	Incorrectly configured ref channel
308	Channel not able to perform requested operation
308	Channel not able to perform requested operation: currently in differential mode

Table 16-5 List of SCPI instrument errors (continued)

Error number	Description
309	Incorrectly formatted channel list
311	Not able to specify resolution with Auto range
521	Input buffer overflow
522	Output buffer overflow
531	Insufficient memory
532	Not able to achieve requested resolution
602	Self-test failed; RAM read/write
626	I/O processor failed self-test
705	Cal: aborted
706	Cal: value out of range
747	Calibration failed
748	Cal checksum failed, internal data
748	Cal: invalid while cal in progress
748	Firmware and FPGA revision mismatch

17 Factory Default Settings

Factory Default Settings [250](#)

The U2300A Series DAQ device SCPI default settings are summarized in this chapter.

Factory Default Settings

The settings in [Table 17-1](#) are used when the U2300A Series DAQ device is powered-on. They are also set once the ***RST** command is sent to the U2300A Series DAQ device.

See also

["*CLS"](#) on page 224

["*RST"](#) on page 232

["SYSTem:ERRor?"](#) on page 179

The following table shows a list of the factory default settings.

Table 17-1 List of the factory default settings

Command	Setting	Remarks
ACQuire:SRATe	1000 Hz	AI sampling rate
ACQuire:POINts	500	Single-shot acquisition points
ACQuire:BURSt	0	Burst mode is disabled
APPLy	SINusoid	AO function
	10 V	Waveform amplitude
	0 V	DC offset
CONFigure:DIgital:DIRectioN	INPut	Input operations enabled
CONFigure:TIMEbase:SOURce	INTernal	Timebase/clock source
CONFigure:TIMEbase:ECLock	10000 kHz	External clock frequency
CONFigure:SSI	NONE	Synchronization is disabled
OUTPut	0	Output is disabled
OUTPut:WAVeform:ITERate	0	Infinite iteration
OUTPut:WAVeform:SRATe	0 Hz	Automatic sampling
OUTPut:WAVeform:FREQuency	4000 Hz	AO frequency
OUTPut:TRIGger:SOURce	NONE	Immediate triggering
OUTPut:TRIGger:TYPE	POST	AO trigger type
TRIGger:DCouNT	0	AO trigger delay
OUTPut:TRIGger:ATRIGger:SOURce	EXTAP	AO trigger control source
OUTPut:TRIGger:ATRIGger:CONDition	BLOW	AO trigger control condition
OUTPut:TRIGger:ATRIGger:HTHReshold	0 V	AO trigger control high-threshold
OUTPut:TRIGger:ATRIGger:LTHReshold	0 V	AO trigger control low-threshold
OUTPut:TRIGger:DTRIGger:POLarity	POS	DIO trigger control polarity
ROUTe:SCAN	(@101)	Scan list
ROUTe:CHANnel:RANGe	10 V	AI range

Table 17-1 List of the factory default settings (continued)

Command	Setting	Remarks
ROUTe:CHANnel:POLarity	BIPolar	AI polarity
ROUTe:CHANnel:STYPe	SING	AI signal type
ROUTe:CHANnel:RSouRCe	INTernal	AO reference voltage source
ROUTe:CHANnel:RVOLtage	10 V	AO reference voltage
ROUTe:ENABle	0	AO channels disabled
[SENSe:]VOLTage:RANGe	AUTO	AI range (polling mode)
[SENSe:]VOLTage:POLarity	BIPolar	AI polarity (polling mode)
[SENSe:]VOLTage:STYPe	SING	AI signal type (polling mode)
[SENSe:]COUNter:FUNctIon	TOTalize	Counter function
[SENSe:]COUNter:GATE:SOURce	INTernal	Counter gate source
[SENSe:]COUNter:GATE:POLarity	AHI	Counter gate polarity
[SENSe:]COUNter:GATE:CONtrol	DIS	Counter gate control
[SENSe:]COUNter:CLock:SOURce	INTernal	Counter clock source
[SENSe:]COUNter:CLock:EXTernal	0	Counter clock external frequency
[SENSe:]COUNter:CLock:POLarity	AHI	Counter clock polarity
[SENSe:]COUNter:TOTalize:IVALue	0	Totalizer measurement initial value
[SENSe:]COUNter:TOTalize:UDOWn:SOURce	INTernal	Totalizer measurement up/down source
[SENSe:]COUNter:TOTalize:UDOWn:DIRectIon	UP	Totalizer measurement up/down direction
SOURce:VOLTage[:LEVel]	0 V	AO supply voltage (single voltage output)
SOURce:VOLTage:POLarity	BIPolar	AO polarity (single voltage output)
SOURce:VOLTage:RSouRCe	INTernal	AO reference voltage source (single voltage output)
SOURce:VOLTage:RVOLtage	10 V	AO reference voltage (single voltage output)
TRIGger:SOURce	NONE	Immediate triggering
TRIGger:TYPe	POST	AI trigger type
TRIGger:DCouNT	0	AI trigger delay
TRIGger:ATRIGger:SOURce	EXTAP	AI trigger control source

Table 17-1 List of the factory default settings (continued)

Command	Setting	Remarks
TRIGger:ATRIgger:CONDition	BLOW	AI trigger control condition
TRIGger:ATRIgger:HTHReshold	0 V	AI trigger control high-threshold
TRIGger:ATRIgger:LTHReshold	0 V	AI trigger control low-threshold
TRIGger:DTRIgger:POLarity	POS	DIO trigger control polarity
WAVEform:POINts	500	Continuous acquisition points
*ESE	0	Standard Event enable register
*SRE	0	Status Byte enable register

THIS PAGE HAS BEEN INTENTIONALLY LEFT BLANK.

Command Quick Reference

Root keyword	Second-level	Third-level	Fourth-level	Fifth-level	Page
ACQuire	:SRATe				See page 30
	:SRATe?				See page 30
	:POINts				See page 33
	:POINts?				See page 33
	:BURSt				See page 36
	:BURSt?				See page 36
APPLy?					See page 40
APPLy	:SINusoid				See page 41
	:SQUare				See page 43
	:SAWTtooth				See page 45
	:TRIngle				See page 47
	:NOISe				See page 49
	:USER				See page 51
CALibration	:BEGIn				See page 54
CONFIgure	:DIGItal	:DIRectIon			See page 56
		:DIRectIon?			See page 56
	:TIMEbase	:SOURce			See page 58
		:SOURce?			See page 58
		:ECLocK			See page 60
		:ECLocK?			See page 60
	:SSI				See page 62
	:SSI?				See page 62
MEASure	[:VOLTagE]	[:DC]?			See page 66
	:COUNter	:DATA?			See page 68

Command Quick Reference

Root keyword	Second-level	Third-level	Fourth-level	Fifth-level	Page
MEASure	:COUNter	:FREQuency?			See page 70
		:PERiod?			See page 72
		:PWIDth?			See page 74
		:TOTalize?			See page 76
	:DIGital?				See page 78
	:DIGital	:BIT?			See page 80
OUTPut?					See page 84
OUTPut					See page 84
	:WAVEform	:ITERate			See page 86
		:ITERate?			See page 86
		:SRATe			See page 88
		:SRATe?			See page 88
		:FREQuency			See page 91
		:FREQuency?			See page 91
	:TRIGger	:SOURce			See page 93
		:SOURce?			See page 93
		:TYPe			See page 95
		:TYPe?			See page 95
		:DCouNT			See page 97
		:DCouNT?			See page 97
		:ATRiGger	:SOURce		See page 99
			:SOURce?		See page 99
	:CONDition		See page 102		
	:CONDition?		See page 102		
	:HTHReshold		See page 105		
	:HTHReshold?		See page 105		

Root keyword	Second-level	Third-level	Fourth-level	Fifth-level	Page	
OUTPut	:TRIGger	:ATRIgger	:LTHReshold		See page 107	
			:LTHReshold?		See page 107	
			:DTRIGger	:POLarity	See page 109	
			:POLarity?	See page 109		
ROUte	:SCAN				See page 112	
			:SCAN?		See page 112	
	:CHANnel	:RANGe			See page 114	
			:RANGe?	See page 114		
			:POLarity	See page 116		
			:POLarity?	See page 116		
			:STYPe	See page 118		
			:STYPe?	See page 118		
			:RSouRCe	See page 120		
			:RSouRCe?	See page 120		
			:RVOLtage	See page 122		
			:RVOLtage?	See page 122		
			:ENABle	See page 124		
			:ENABle?	See page 124		
[SENSe:]	VOLTagE	:RANGe		See page 128		
			:RANGe?	See page 128		
			:POLarity	See page 131		
			:POLarity?	See page 131		
			:STYPe	See page 133		
			:STYPe?	See page 133		
			COUNter	:FUNction		See page 136
					:FUNction?	See page 136

Command Quick Reference

Root keyword	Second-level	Third-level	Fourth-level	Fifth-level	Page
[SENSe:]	COUNter	:ABORt			See page 138
		:GATE	:SOURce		See page 140
			:SOURce?		See page 140
			:POLarity		See page 142
			:POLarity?		See page 142
			:CONTRol		See page 144
			:CONTRol?		See page 144
		:CLock	:SOURce		See page 146
			:SOURce?		See page 146
			:INTernal?		See page 148
			:EXTernal		See page 149
			:EXTernal?		See page 149
			:POLarity		See page 151
			:POLarity?		See page 151
		:TOTalize	:IVALue		See page 153
			:IVALue?		See page 153
			:INITiate		See page 155
			:CLEar		See page 156
			:UDOWn	:SOURce	See page 158
				:SOURce?	See page 158
				:DIRection	See page 160
				:DIRection?	See page 160
SOURce	:VOLTage	[:LEVeL]			See page 164
		[:LEVeL]?			See page 164
		:POLarity			See page 166
		:POLarity?			See page 166

Root keyword	Second-level	Third-level	Fourth-level	Fifth-level	Page	
SOURce	:VOLTage	:RSouRCe			See page 168	
		:RSouRCe?			See page 168	
		:RVOLTage			See page 170	
		:RVOLTage?			See page 170	
	:DIGital	:DATA			See page 172	
		:DATA?			See page 172	
				:BIT		See page 174
				:BIT?		See page 174
SYSTem	:CDEscription?				See page 178	
	:ERRor?				See page 179	
TRIGger	:SOURce				See page 182	
	:SOURce?				See page 182	
	:TYPe				See page 184	
	:TYPe?				See page 185	
	:DCouNT				See page 187	
	:DCouNT?				See page 187	
	:ATRIgger	:SOURce				See page 189
						See page 189
			:CONDition			See page 192
		:CONDition?				See page 192
			:HTHReshold			See page 195
			:HTHReshold?			See page 195
	:LTHReshold				See page 197	
				See page 197		
:DTRIgger		:POLarity			See page 199	
		:POLarity?			See page 199	

Command Quick Reference

Root keyword	Second-level	Third-level	Fourth-level	Fifth-level	Page
WAVEform	:DATA?				See page 202
	:POINTs				See page 204
	:STATus?				See page 207
	:COMPlete?				See page 209
DIGitize					See page 212
RUN					See page 214
STOP					See page 216
MODel?					See page 217
SERial?					See page 218
DATA	[:USER]				See page 219
*CLS					See page 224
*ESE					See page 225
*ESE?					See page 225
*ESR?					See page 227
*IDN?					See page 228
*OPC					See page 229
*OPC?					See page 229
*RCL					See page 230
*RST					See page 232
*SAV					See page 233
*SRE					See page 234
*SRE?					See page 234
*STB?					See page 236
*TST					See page 237
*WAI					See page 238



This information is subject to change without notice. Always refer to the Keysight website for the latest revision.

© Keysight Technologies 2006-2017
Edition 8, June 1, 2017

Printed in Malaysia



U2351-90202

www.keysight.com