

# Bluetooth® Measurement Fundamentals

## Application Note

*Bluetooth*® wireless technology is an open specification for a wireless personal area network (PAN). It provides limited range wireless connectivity for voice and data transmissions between information appliances. *Bluetooth* wireless technology eliminates the need for interconnecting cables. Unique for most wireless communications systems, *Bluetooth* enables ad hoc networking among devices, without the need for infrastructure such as base stations or access points.

Named after a tenth-century Danish King, *Bluetooth* invokes images of Viking conquests and plundering; notwithstanding this, the good King Harald Blatand is credited with uniting Denmark and Norway during his reign. Similarly today, *Bluetooth* unites devices through its wireless communications link.

*Bluetooth* wireless technology allows seamless interconnectivity among devices. Imagine your computer synchronizing files and databases with your personal digital assistant (PDA), simply because you carried the PDA into the vicinity of the PC.



Wireless headsets can simplify hands-free operation of mobile phones as a convenient and safe way to talk while driving. The potential of this technology is limitless when one considers the growing sector of information appliances that would benefit from wireless connectivity. This application note describes transmitter and receiver measurements to test and verify *Bluetooth* RF including enhanced data rate (EDR) designs. Test procedures range from manual

intervention or custom software control, to easy-to-use, one-button measurements. A list of Agilent Technologies solutions for *Bluetooth* measurements is provided in *Appendix D: Agilent Solutions for Bluetooth Wireless Technology*. This application note assumes a basic understanding of RF measurements. To learn more about basic RF measurements, refer to *Appendix C: Recommended Reading for Bluetooth*, at the end of this application note.



# Table of Contents

---

<b>Introduction</b> .....	<b>1</b>
<b>1. Basic Concepts of <i>Bluetooth</i></b> .....	<b>3</b>
1.1 <i>Bluetooth</i> radio unit .....	4
1.2 <i>Bluetooth</i> link control unit and link management .....	6
1.3 <i>Bluetooth</i> RF test suite structure ..	8
<b>2. Transmitter Measurements</b> .....	<b>10</b>
2.1 Test conditions and setup .....	10
2.2 Power tests .....	13
2.3 Transmit output spectrum .....	16
2.4 Modulation tests .....	18
2.5 Timing tests .....	23
<b>3. Transceiver Measurements</b> .....	<b>26</b>
3.1 EDR in-band spurious emissions ..	26
<b>4. Receiver Measurements</b> .....	<b>27</b>
4.1 Test conditions and setup .....	27
4.2 Sensitivity - single-slot packets ..	30
4.3 Sensitivity - multi-slot packets ..	31
4.4 EDR sensitivity .....	31
4.5 EDR BER floor performance .....	31
4.6 Carrier-to-interference (C/I) performance .....	32
4.7 EDR carrier-to-interference (C/I) performance .....	32
4.8 Blocking performance .....	33
4.9 Intermodulation performance .....	33
4.10 Maximum input level .....	33
4.11 EDR maximum input level .....	33
<b>5. Power Supply Measurements</b> ..	<b>34</b>
<b>Appendix A: Glossary</b> .....	<b>35</b>
<b>Appendix B: Symbols and Acronyms</b> ..	<b>36</b>
<b>Appendix C: Recommended Reading</b> ..	<b>37</b>
<b>Appendix D: Agilent Solutions for <i>Bluetooth</i></b> .....	<b>38</b>
<b>Appendix E: References</b> .....	<b>39</b>

# 1. Basic Concepts of *Bluetooth*

*Bluetooth*, in its most elementary form, is defined as a global specification for wireless connectivity. Because it is intended to replace cables, cost must be low and operation must be intuitive and robust. These requirements for *Bluetooth* create many challenges. *Bluetooth* meets these challenges by several means. The radio unit employs frequency hopping spread spectrum (FHSS), and the design emphasis is on very low power, extremely low cost, and robust operation in the uncoordinated, interference-dominated RF environment of the industrial, scientific, and medical (ISM) radio band.

A wide variety of *Bluetooth* radio block diagrams are in use. For transmission, these range from direct voltage controlled oscillator (VCO) modulation to IQ mixing at the final radio frequency (RF.) In the receiver, a conventional frequency discriminator or IQ down-conversion combined with analog-to-digital conversion is noted.

While many options can satisfy the *Bluetooth* radio specifications, each will have its own characteristics if not operating correctly. The *Bluetooth* system consists of a radio unit, a baseband link control unit, and link management software. It also includes higher-level software utilities that focus on interoperability features and functionality. Figure 1 is a block diagram for this type of frequency hopping system, showing the baseband controller and the RF transmitter and receiver sections.

EDR is an enhancement to the *Bluetooth* 1.2 standard and is described in the *Bluetooth* 2.0 specification. It is backwards compatible with the earlier *Bluetooth* standards. It uses a phase shift keying (PSK) modulation scheme to achieve a data rate of 2 or 3 Mb/s. It allows greater possibilities for using multiple devices on the same connection because of the increased bandwidth. Due to EDR having a reduced duty cycle, there is lower power consumption compared to a standard *Bluetooth* link.

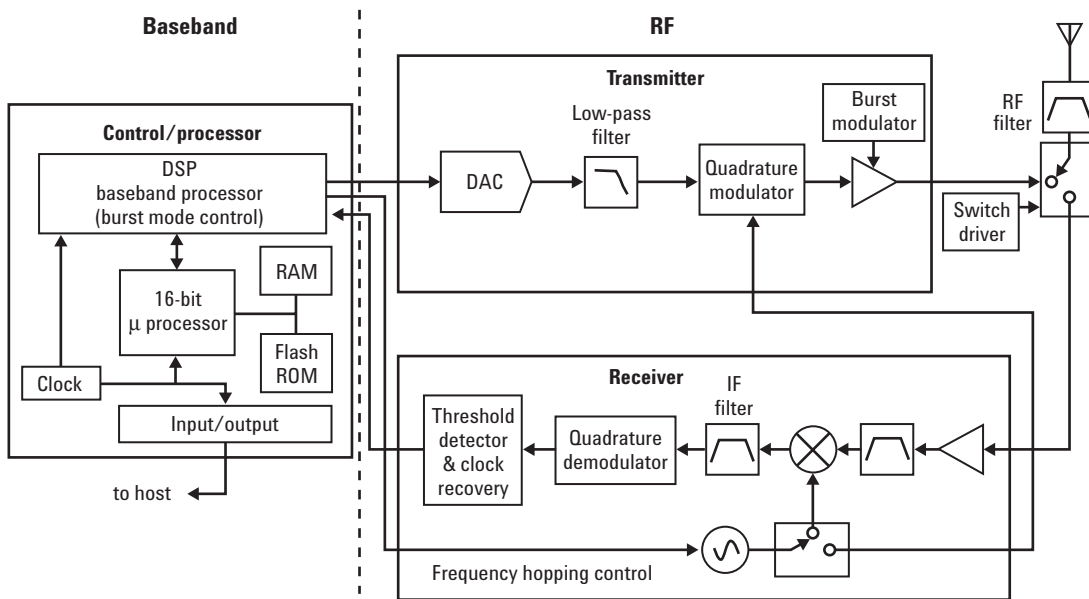

Figure 1. Block diagram of a *Bluetooth* system

## 1.1 Bluetooth radio unit

The *Bluetooth* radio unit is shown in Figure 1 as the transmitter and receiver sections of the block diagram. The transmitter up-converts the baseband information to the frequency-modulated carrier. Frequency hopping and bursting are performed at this level. Conversely, the receiver down-converts and demodulates the RF signal. Table 1 summarizes some of the key RF characteristics of *Bluetooth*.

The *Bluetooth* channels are each 1 MHz wide. The frequency hopping occurs over the 79 channels. Figure 2 depicts the frequency hopping channels, divided by geographic regions.

The modulation in a standard *Bluetooth* system is Gaussian frequency shift keying (GFSK) this gives a gross air data rate of 1 Mb/s. This is a digital modulation format

in which the modulated carrier shifts between two frequencies representing a “1” and a “0”. As a result, GFSK provides one bit of data per symbol. Figure 3 is an example of GFSK modulation illustrating the two discrete frequencies. Unlike many other forms of digital modulation, such as GSM, amplitude and phase are not of primary concern in this type of modulation scheme.

**Table 1. Key Bluetooth RF characteristics**

Characteristic	Specification	Notes
<b>Carrier frequency<sup>1</sup></b>	2400 to 2483.5 MHz (ISM radio band)	$f = 2402 + k$ MHz, $k = 0, 1, 2, \dots, 78$
<b>Modulation</b>	Standard 0.5 BT Gaussian-filtered 2FSK at 1 Msymbol/s Modulation index: 0.28 to 0.35 (0.32 nominal) 0.4 BT $\pi/4$ -DQPSK at 2 Msymbol/s 0.4 BT 8DPSK at 3 Msymbol/s	Digital FM scheme The peak frequency deviation allowed is 175 kHz
<b>Hopping</b>	1600 hops/s (in normal operation) <sup>2</sup> 1 MHz channel spacing 1) page hopping sequence 2) page response sequence 3) inquiry sequence 4) inquiry response sequence 5) channel hopping sequence The first four are restricted hopping sequences used during connection setup. The normal channel hopping sequence is pseudorandom based on the master clock value and device address.	The channel hopping sequence is designed to visit each frequency regularly and with roughly equal probability. The system has five different hopping sequences. It has a periodicity of 23 hours and 18 minutes.
<b>Transmit power</b>	Power class 1: 1 mW (0 dBm) to 100 mW (20 dBm)  Power class 2: 0.25 mW (-6 dBm) to 2.5 mW (+4 dBm)  Power class 3: 1 mW (0 dBm) max power	Class 1 power control: +4 to +20 dBm (required) -30 to +4 dBm (optional) Class 2 power control: -30 to 0 dBm (optional) Class 3 power control: -30 to 0 dBm (optional)
<b>Operating range</b>	10 cm to 10 m (100 m with power class 1)	Range depends on amount of interference
<b>Maximum data throughput</b>	The asynchronous channel can support an asymmetric link of maximally 721 kb/s in either direction while permitting 57.6 kb/s in the return direction, or a 432.6 kb/s symmetric link. EDR 3 Mb/s has a real data throughput of 2.1 Mb/s	Data throughput is lower than the 1 Msymbol/s rate as a result of the overhead, which is inherent in the protocol

1. The *Bluetooth* specification includes a special frequency hopping pattern to provide provisions for compliance with national limitations such as those in France. The frequency range for France is 2.4454 to 2.4835 GHz and the corresponding RF channels are  $f = 2454 + k$  MHz,  $k = 0, \dots, 22$ .

2. Hop speed may vary, depending on packet length.

As an enhancement to the *Bluetooth* standard, EDR uses different modulation schemes so that data can be sent at higher transmission rates. There are two different types of modulation that EDR utilizes,  $\pi/4$ -DQPSK for 2 Mb/s and 8DPSK for 3 Mb/s gross air data transfer rates.  $\pi/4$ -DQPSK uses changes in the

waveforms phase to carry information. Figure 4 shows the  $\pi/4$ -DQPSK modulation phase diagram. Each point represents two bits of data. The modulation for the 3 Mb/s uses the same principle of waveform phase shifting but the main difference is that each change contains three bits of information.

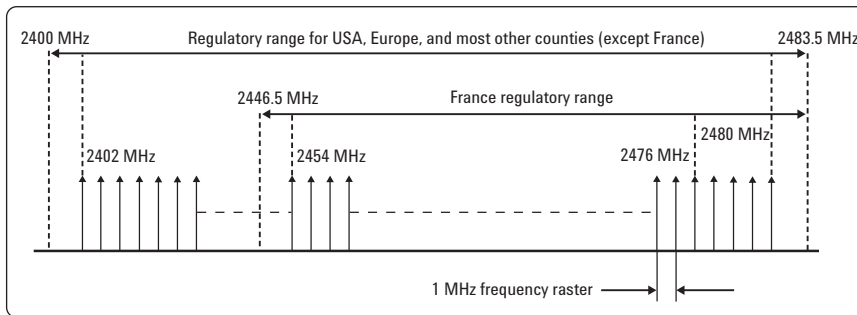

Figure 2. *Bluetooth* frequency bands and channel arrangement

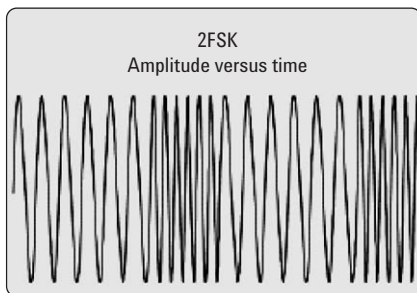

Figure 3. 2FSK modulation

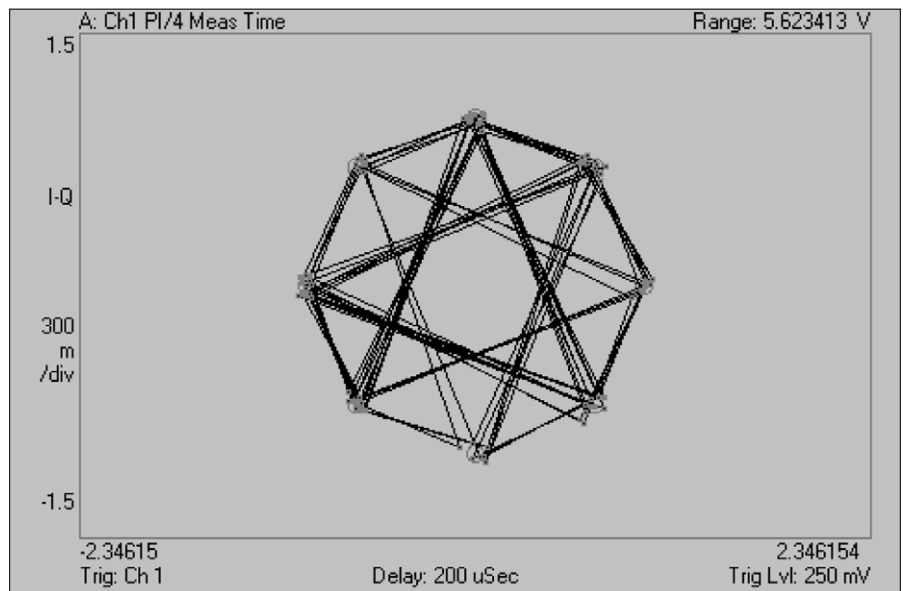

Figure 4. Agilent 89600 showing the  $\pi/4$  DQPSK modulation data points for 2 Mb/s data transfer

## 1.2 Bluetooth link control unit and link management

The *Bluetooth* link control unit, also known as the link controller, determines the state of the device and is responsible for establishing the network connections as well as power efficiency, error correction, and encryption.

The link management software works with the link control unit. Devices communicate among each other through the link manager. Table 2 provides a summary of the link control and management functions. Link management does not change for EDR.

**Table 2. Summary of link control and management functions**

Function	Description	Notes
<b>Network connections</b>	The master's link controller initiates the connection procedure and sets the power-saving mode of the slave	
<b>Link types</b>	Two link types: <ul style="list-style-type: none"> <li>• Synchronous connection-oriented (SCO) type, primarily for voice</li> <li>• Asynchronous connectionless (ACL) type, primarily for packet data</li> </ul>	<i>Bluetooth</i> can support an asynchronous data channel, up to three simultaneous synchronous voice channels, or a channel that simultaneously supports asynchronous data and synchronous voice. Time-division duplexing for full duplex operation
<b>Packet types</b>	<p><b>Standard rate</b> NULL, POLL, FHS-system packets</p> <p>DM1, DM3, DM5-medium rate, error-protected data packets of time slots occupied by the data burst</p> <p>DH1, DH3, DH5-high rate, non-protected data packets</p> <p>HV1, HV2, HV3-digitized audio, three levels of error protection; ominal burst lengths DV-mixed data and voice, synchronous or asynchronous</p> <p>AUX1-for other uses</p> <p><b>2 Mb/s packets</b> 2-EV3, 2-EV5- same as standard rate packet but modulated using <math>\pi/4</math>-DQPSK</p> <p>2-DH1, 2-DH3, 2-DH5-same as standard rate packet but modulated using <math>\pi/4</math>-DQPSK</p> <p><b>3 Mb/s packets</b> 3-EV3, 3-EV5-same as standard rate packet but modulated using 8DQPSK</p> <p>3-DH1, 3-DH3, 3-DH5-same as standard rate packet but modulated using 8DPSK</p>	The 1, 3, and 5 suffixes indicate the number: DH1-366 $\mu$ s DH3-1622 $\mu$ s DH5-2870 $\mu$ s
<b>Error correction</b>	Three error correction schemes: <ul style="list-style-type: none"> <li>• 1/3 rate forward error correction (FEC) code</li> <li>• 2/3 rate FEC code</li> <li>• automatic repeat request (ARQ) scheme for data</li> </ul>	Error correction is provided by the link manager
<b>Authentication</b>	Challenge-response algorithm; authentication may be unused, unidirectional, or bidirectional	Authentication is provided by the link manager
<b>Encryption</b>	Stream cipher with variable secret key lengths	
<b>Test modes</b>	Provides the ability to place the device into test loopback mode and allows control of test parameters such as frequency settings, power control, and packet type	

Bluetooth radios may operate as either master or slave units. The link manager sets up the connection between master and slave units and also determines the slave's power-saving mode. A master can be actively communicating with up to seven slaves, while another 200+ slaves can be registered in a non-communicating, power-saving mode. This area of control is defined as a piconet. A master in one piconet may be a slave to a master from a different piconet. Similarly, multiple masters from different piconets may control a single slave. This network of

piconets is referred to as a scatternet. Figure 5 depicts two piconets comprising a scatternet. Units that are not part of either piconet remain in standby mode.

The Bluetooth transmission is divided into time slots, where each slot corresponds to an RF hop frequency. In the time division duplex (TDD) scheme used, the master transmits in even-numbered time slots, and the slave in odd numbered time slots. Voice bits or data bits within piconets are transmitted in packets. Packets transmitted by the master or the

slave may extend over one, three, or five time slots. A packet for standard Bluetooth transmission, shown in Figure 6, contains an access code, a header, and a payload. The access code consists of a preamble, a sync word, and an optional trailer. The header contains piconet address and packet information. The payload carries the user's voice or data information. Refer to *Specification of the Bluetooth System, Part B: Baseband Specification*, [Reference 2] for further details on packet construction.

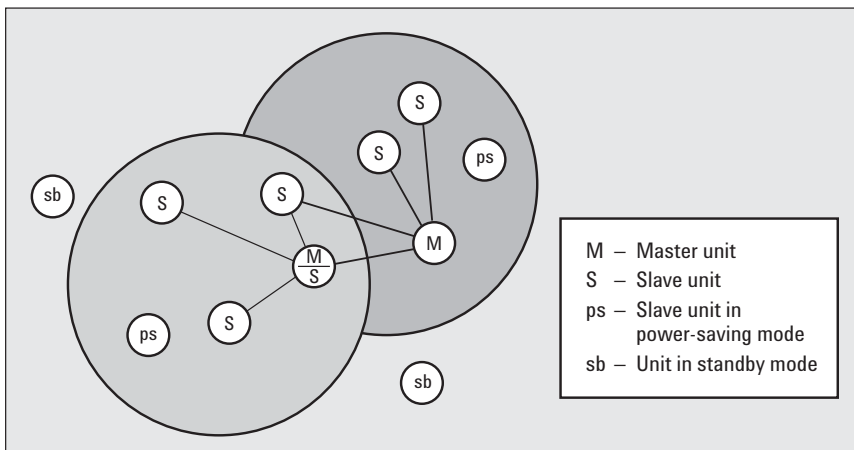

Figure 5. Network topology

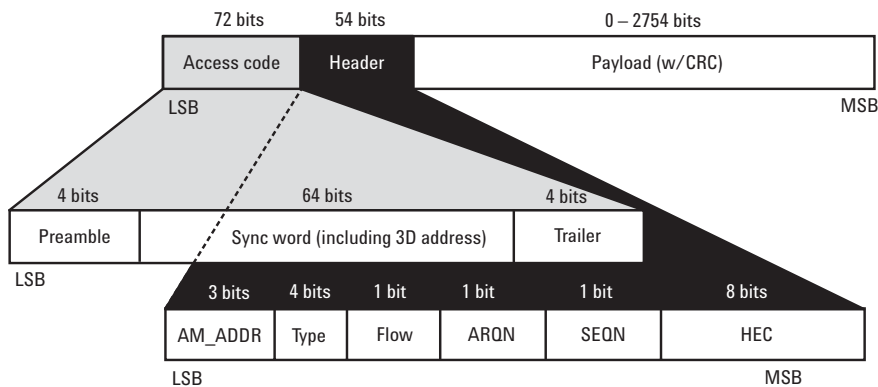

Figure 6. Standard Bluetooth general packet format showing contents of the access code and header

The packet for an EDR transmission varies slightly from the standard *Bluetooth* packet. The *Bluetooth* EDR packet is shown in Figure 7. When EDR is being used to transmit data, the first section of the packet containing the access code and header is transmitted using the standard *Bluetooth* GFSK modulation. After a guardband, the modulation is changed to  $\pi/4$ -DQPSK or 8DPSK, depending on which data rate the device uses. The synchronization, main data payload and the closing trailer sections are all transmitted using the higher data rate modulation scheme.

### 1.3 *Bluetooth* RF test suite structure

The *Bluetooth* radio is Layer 1 of the *Bluetooth* protocol stack. Figure 8 shows a configuration of this *Bluetooth* protocol stack with the different basic layers.

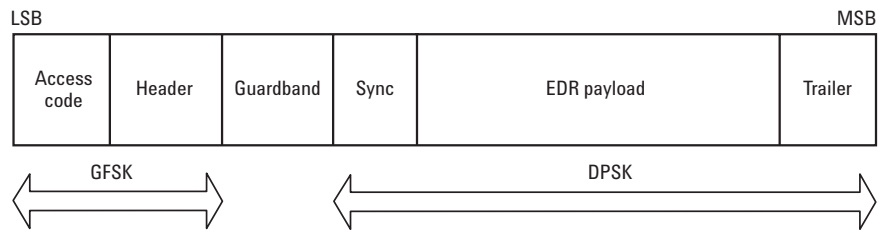

Figure 7. EDR *Bluetooth* packet format

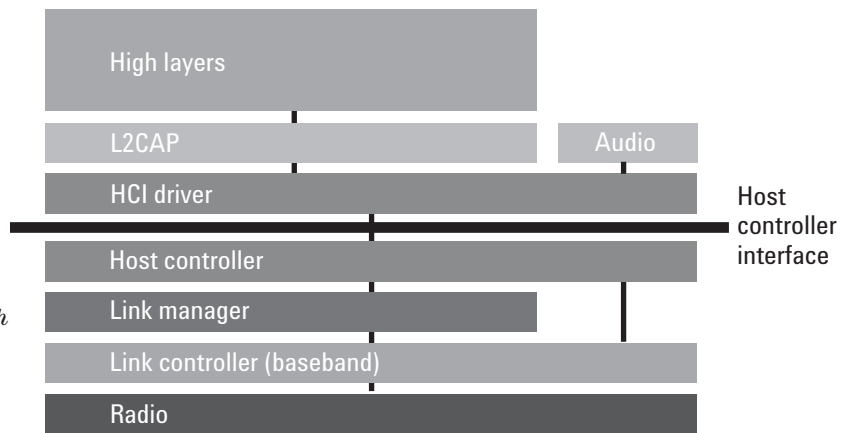

Figure 8. *Bluetooth* protocol stack; basic layers



The *Bluetooth* Special Interest Group (SIG) has proposed a list, entitled “Bluetooth *RF Test Suite Structure*,” which defines tests to perform for certification of the *Bluetooth* radio layer. Table 3 provides this list of tests with their test purpose identifiers.

The following sections of this application note provide a description of these different tests and how they can be performed. For specific information on test requirements, such as initial condition, test procedure, test condition, or expected outcome, refer to the *Bluetooth Test Specification - RF* [Reference 1]. This document has been defined by the *Bluetooth* SIG and is the definitive guide.<sup>1</sup>

**Table 3. Bluetooth RF test suite structure**

Test cases for certification testing of the <i>Bluetooth</i> RF Layer	Identifier <sup>1</sup>
<b>Transmitter tests</b>	
Output power	TRM/CA/01/C
Power density	TRM/CA/02/C
Power control	TRM/CA/03/C
Tx output spectrum-frequency range	TRM/CA/04/C
Tx output spectrum-20 dB bandwidth	TRM/CA/05/C
Tx output spectrum-adjacent channel power	TRM/CA/06/C
Modulation characteristics	TRM/CA/07/C
Initial carrier frequency tolerance	TRM/CA/08/C
Carrier frequency drift	TRM/CA/09/C
<b>Receiver tests</b>	
Sensitivity/single-slot packets	RCV/CA/01/C
Sensitivity/multi-slot packets	RCV/CA/02/C
C/I performance	RCV/CA/03/C
Blocking performance	RCV/CA/04/C
Inter-modulation performance	RCV/CA/05/C
Maximum input level	RCV/CA/06/C
<b>Bluetooth EDR RF test suite structure</b>	
<b>Transmitter tests</b>	
Enhanced data rate relative transmit power	TRM/CA/10/C
Enhanced data rate carrier frequency stability and modulation accuracy	TRM/CA/11/C
Enhanced data rate differential phase encoding	TRM/CA/12/C
Enhanced data rate in-band spurious emission	TRM/CA/13/C
<b>Receiver tests</b>	
Enhanced data rate sensitivity	RCV/CA/07/C
Enhanced data rate BER floor sensitivity	RCV/CA/08/C
Enhanced data rate C/I performance	TP/RCV/CA/09/C
Enhanced data rate maximum input level	RCV/CA/10/C

<sup>1</sup>Note: Identifier format is: (Test)/CA/NN/C, in which

TRM = Transmitter test

TRC = Transceiver test

RCV = Receiver test

CA = Capability test (defines the type of testing)

NN = Test purpose number

C = Conformance test performed on dedicated *Bluetooth* test system (defines the scope)

1. At the time of this writing, the revision of this document is 2.0.E.3 (Test Specification RF for Specification 2.0 - March 21, 2005). Since then, some errata in this document may have been listed on the Bluetooth SIG web site under “TEST SPECIFICATION ERRATA.” Refer to this for up-to-date test requirements.

## 2. Transmitter Measurements

This chapter provides a framework for the *Bluetooth* transmitter tests and test methodology. It describes the measurements that can be made on *Bluetooth* components and systems. Examples and supporting information are provided.

### 2.1 Test conditions and setup

#### 2.1.1 Test conditions

Table 4 is a summary list of the conditions under which the transmitter tests need to be performed.

**Table 4. Transmitter test conditions**

	Frequency hopping	Test mode	Packet type	Payload data	Measurement bandwidth
Output power TRM/CA/01/C	On	Loopback <sup>1</sup>	DH5 <sup>2</sup>	PRBS 9	3 MHz RBW 3 MHz VBW
Power density TRM/CA/02/C	On	Loopback <sup>1</sup>	DH5 <sup>2</sup>	PRBS 9	100 kHz RBW 100 kHz VBW
Power control TRM/CA/03/C	Off	Loopback <sup>1</sup>	DH1	PRBS 9	3 MHz RBW 3 MHz VBW
Tx output spectrum-frequency range TRM/CA/04/C	Off	Loopback <sup>1</sup>	DH5 or DM5 <sup>2</sup>	PRBS 9	100 kHz RBW 300 kHz VBW
Tx output spectrum –20 dB bandwidth TRM/CA/05/C	Off	Loopback <sup>1</sup>	DH5 or DM5 <sup>2</sup>	PRBS 9	10 kHz RBW 30 kHz VBW
Tx output spectrum-adjacent channel power TRM/CA/06/C	Off	Loopback	DH1	PRBS 9	100 kHz RBW 300 kHz VBW
Modulation characteristics TRM/CA/07/C	Off	Loopback <sup>1</sup>	DH5 or DM5 <sup>2</sup>	11110000 10101010	–
Initial carrier frequency tolerance TRM/CA/08/C	On	Loopback <sup>1</sup>	DH1	PRBS 9	–
Carrier frequency drift TRM/CA/09/C	On	Loopback <sup>1</sup>	DH1 DH3 DH5 <sup>2</sup>	10101010	–
<b>EDR transmitter test conditions</b>					
EDR relative transmit power TRM/CA/10/C	Off	Loopback <sup>1</sup>	2-DHx or 2-Evx 3-DHx or 3-Evx <sup>2,3</sup>	PRBS 9	3 MHz RBW 3 MHz VBW
EDR carrier frequency stability and modulation accuracy TRM/CA/11/C	Off	Loopback <sup>1</sup>	2-DH5 or 3-DH5 <sup>2,3</sup>	PRBS 9	–
EDR differential phase encoding TRM/CA/12/C	Off	Tx	2-DH1 or 2-EV3 3-DH1 or 3-EV3 <sup>2,3</sup>	PRBS 9	–
EDR in band spurious emissions TRM/CA/13/C	Off	Loopback	2-DHx or 2-Evx 3-DHx or 3-Evx <sup>2,3</sup>	PRBS 9	100 kHz RBW 300 kHz VBW

1. If loopback is not available, the use of Tx (transmitter mode) is allowed.

2. If packet is not supported, use the longest supported packets (with the longest supported payload length).

3. The packet to be used depends on what modulation scheme is being tested number 2 prefix for  $\pi/4$  DQPSK and number 3 prefix for 8DPSK.

### Payload data

Notice that three different types of payload data are called for in different test cases. They are PRBS9, 10101010, and 11110000. Each pattern provides different stress mechanisms and is selectively chosen for each measurement. PRBS9 is a pseudorandom bit sequence of period  $2^9-1$  that is intended to simulate live traffic and so produces a modulated signal with a spectral distribution approximating that of a real signal. The 10101010 pattern provides an additional test for the modulation filter. It also changes the spectral shape of the transmitter output. The 11110000 pattern allows a check of the Gaussian filtering. After a series of four 1s or four 0s, the output should have reached its fully settled condition. The use of different patterns also helps identify problems with IQ modulation schemes. Note that an ideal Gaussian filter will produce a ratio of 88 percent between the peak frequency deviation of a 10101010 signal and that of the 11110000 signal. The *Bluetooth* radio specification calls for > 80 percent to be achieved.

### Frequency hopping

The adaptive frequency hopping of the *Bluetooth* system adds a further degree of complexity to signal analysis. Hopping is needed for testing the functional capability of the *Bluetooth* device, whereas for parametric tests, hopping is not essential. To reduce the number of variables and identify individual performance characteristics, hopping is turned off for a number of tests. However, the transmit and receive channels can be set at the extreme ends of the band, forcing the VCO in the device under test (DUT) to switch frequency. Each method is tailored to the requirements of the test and is documented in the *Bluetooth Test Specification*.

### Test mode

The *Bluetooth* device can operate in different modes:

- normal mode
- transmitter (Tx) test mode
- loopback test mode

Normal mode consists of having a standard *Bluetooth* communication. For instance, when the tester is acting as a master and the *Bluetooth* device as a slave, in normal mode the tester will send some POLL packets and the device will confirm the reception of these packets by sending back a NULL packet. The description of POLL and NULL packets can be found in *Specification of the Bluetooth System, Part B: Baseband Specification* [Reference 2].

In Test mode, the *Bluetooth* device is operating in a specific state. In Loopback test mode, the *Bluetooth* device (slave) is asked to decode the packets sent by the tester (master) and send back the payload using the same packet type. While in Transmitter test mode, the *Bluetooth* device is simply asked to transmit a type of packet according to specific instructions sent by the tester (master)

via POLL packets. An illustration of Loopback and Transmitter test mode is provided in Figure 9.

The implementation of Test mode in *Bluetooth* devices is required to facilitate testing of transmitter and receiver performance of a device. By putting the device into Test mode, different transmission and/or reception parameters can be controlled, such as frequency selection, Tx frequency, packet type and length, bit pattern, poll period, and power level.

**Note:** To allow the tester (master) to put the device (slave) into Test mode, the host device will need to send a special command (LMP command) in order to prepare the device to enter Test mode. That is one of the reasons why in the different setups presented in the following sections, a DUT controller is included. The control could be performed either by protocol sent over an RF connection or by direct digital control of the device. For more details on Test mode and its activation, refer to page 285, “Test Mode,” in the *Specification of the Bluetooth System* [Reference 2].

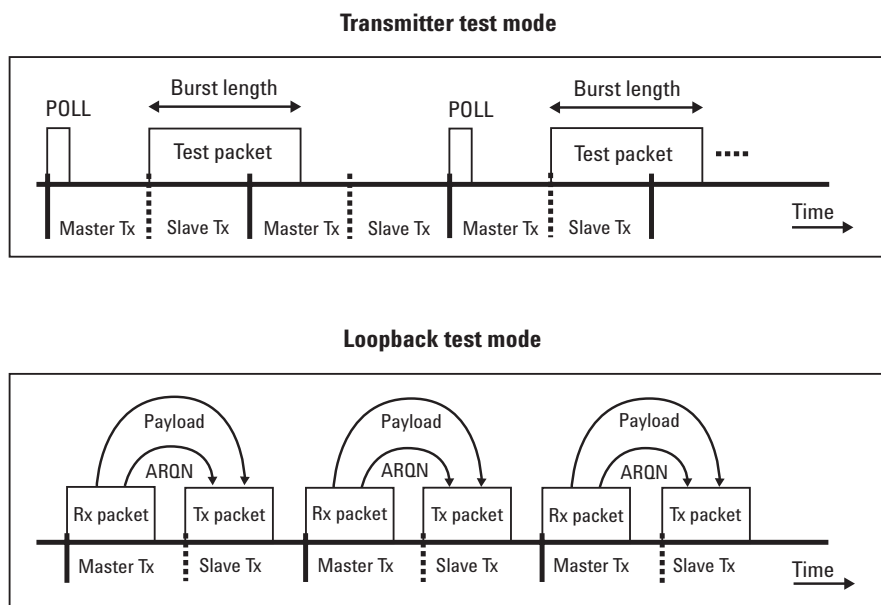

Figure 9. Loopback and Transmitter test mode

### 2.1.2 Test setup

Different setups may be used for *Bluetooth* transmitter tests, depending on whether you are testing a full functional *Bluetooth* device or just the RF transmitter, or even RF components of the transmitter. One way to test transmitter performance of a full functional *Bluetooth* device is to use a *Bluetooth* test set, such as the Agilent N4010A. The test set and DUT form a piconet where the tester acts as master and the DUT acts as slave. The test set establishes a link (paged connection) with the device in either Normal or Test mode using the standard *Bluetooth* protocol. With the device in Test mode, the test set will have complete control of DUT operation. For instance, the test set can put the device into Loopback mode or Tx mode, disable frequency hopping, and ask the device to transmit at specific frequencies as required by the *Bluetooth Test Specification*.

Figure 10 shows this basic setup with the Agilent N4010A *Bluetooth* test set.

Two other types of transmitter measurement setups are illustrated in Figure 11. Setup 1 is an example of a setup to test transmitter spectral performance of a full functional *Bluetooth* module, while Setup 2 is used for testing a broad range of the *Bluetooth* DUT performance.

Setup 1 differs from the setup of Figure 10 in that there is no *Bluetooth* communication established between the device and the test equipment, so the test equipment doesn't have any control of the DUT operation. For this setup, a special internal test facilities utility must be implemented in the device. This utility must have the ability to ask to the device to transmit the packets it receives. This will allow a *Bluetooth* signal from the digital signal generator to be transmitted into the device's receiver and looped back through its transmitter for analysis.

For Setup 2, the utility must have the capability to control the type of transmission (frequency hopping on or off, different types of packets, etc.) in order to provide the right conditions to test the *Bluetooth* transmitter (see Table 4.) This can be performed from the N4010A or by linking with a PC and controlling the device with suitable software. These two setups require the use of a signal analyzer, which could be a spectrum analyzer or a vector signal analyzer. Additional equipment includes signal generators and possibly a power meter, power supply, oscilloscope, and network analyzer.

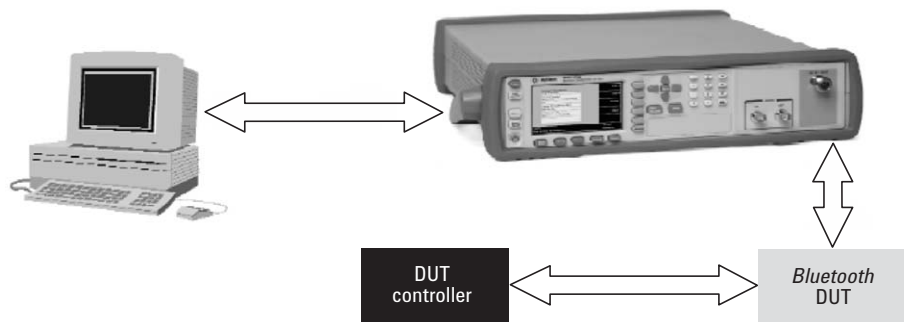
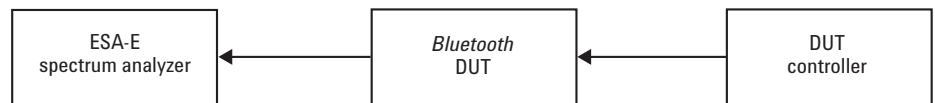
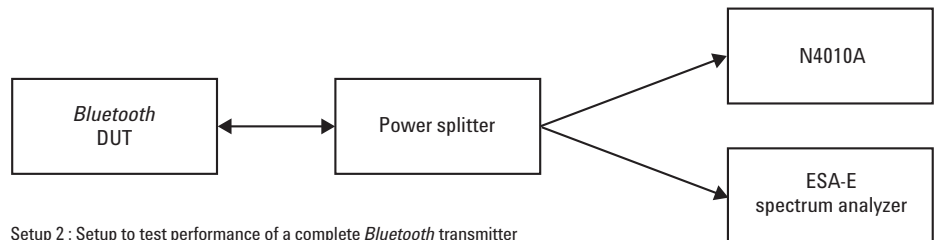

Figure 10. Example of a setup to test transmitter performance of a full functional *Bluetooth* device; the Agilent N4010A *Bluetooth* test set is acting as a master, while the *Bluetooth* DUT is acting as a slave



Setup 1 : Transmitter performance test setup for a full functional *Bluetooth* device that is able to be controlled by a DUT controller



Setup 2 : Setup to test performance of a complete *Bluetooth* transmitter

Figure 11. Example of two other transmitter measurement setups

If a direct cable connection is not possible between the *Bluetooth* device and the measurement equipment, a suitable coupling device such as an antenna will be necessary. The path loss between antennas should be accounted for in the calculations. This can be evaluated using a network analyzer. The Agilent N4017A software allows compensations for path loss when performing calculations. When a specification requires the device to be tested using three different levels in the frequency band, Table 5 shows the different frequencies that are used when in loopback and transmit test cases. Table 6 shows the table for receiving test cases. Table 7 shows the configuration when in Tx mode. Hopping is turned off when using these settings.

## 2.2 Power tests

RF transmitter power measurements include output power (average power and maximum peak power in a burst), power density, power control, and EDR relative transmit power. Power level is a critical parameter in digital communication systems. These tests help to ensure that power levels are high enough to maintain links, yet low enough to minimize interference within the ISM band and to maximize battery life.

### 2.2.1 Output power

Output power measurements are performed in the time domain. Because the *Bluetooth* signal is a sequence of TDD bursts, it is necessary to trigger properly. Triggering occurs on the rising edge of the envelope to obtain a viewable signal.

Figure 12 illustrates power and timing characteristics of a standard *Bluetooth* signal burst in the time domain.

**Table 5. Frequency settings for transmitting in loopback mode**

Low operating frequency	Mid operating frequency	High operating frequency
DUT $f_{TX}$	DUT $f_{RX}$	DUT $f_{TX}$
DUT $f_{RX}$	DUT $f_{TX}$	DUT $f_{RX}$
2402 MHz	2480 MHz	2441 MHz
2402 MHz	2480 MHz	2402 MHz

**Table 6. Frequency settings for receiving in loopback mode**

Low operating frequency	Mid operating frequency	High operating frequency
DUT $f_{TX}$	DUT $f_{RX}$	DUT $f_{TX}$
DUT $f_{RX}$	DUT $f_{TX}$	DUT $f_{RX}$
2480 MHz	2402 MHz	2402 MHz
2441 MHz	2402 MHz	2480 MHz

**Table 7. Frequency settings for Tx mode**

Low operating frequency	Mid operating frequency	High operating frequency
DUT $f_{TX}$	DUT $f_{TX}$	DUT $f_{TX}$
2402 MHz	2441 MHz	2480 MHz

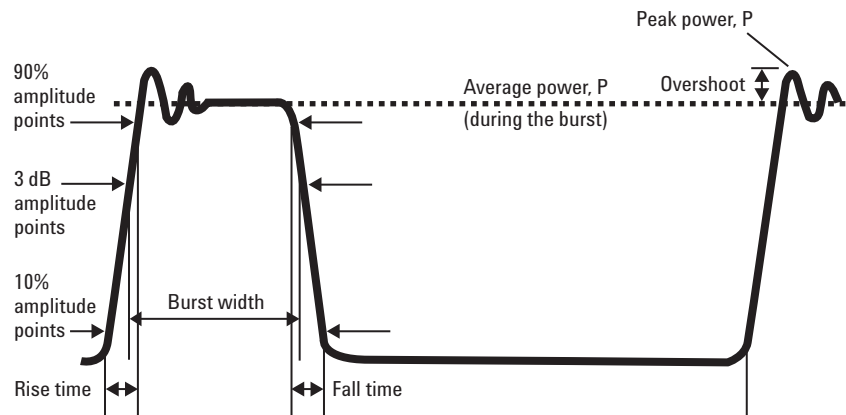

**Figure 12. Time domain power and timing analysis**

Average power and peak power measurements can be performed either by a *Bluetooth* test set, a power meter, a spectrum analyzer, or a vector signal analyzer. For any of these testers, the tester records the highest power value in the burst and calculates the average power from 20 to 80 percent of the duration of the burst. The duration of the burst (burst width) is the time between the leading and trailing 3 dB points compared to the average power.

Figure 13 shows an output power measurement performed with an N4010A test set and N4017A graphic measurement application (GMA.)

Using a swept-tuned spectrum analyzer, view the envelope of the signal in the time domain by setting the span to zero. External triggering can be used to capture the burst mode signal. The number of periods displayed is controlled by the sweep time. Using peak detector mode, set the trace to max hold and measure the peak power level using peak search. The average power of the burst is also determined by analyzing the trace data. The test is repeated for all frequency channels. Figure 14 shows a display of an average and peak power measurement on a swept-tuned spectrum analyzer.

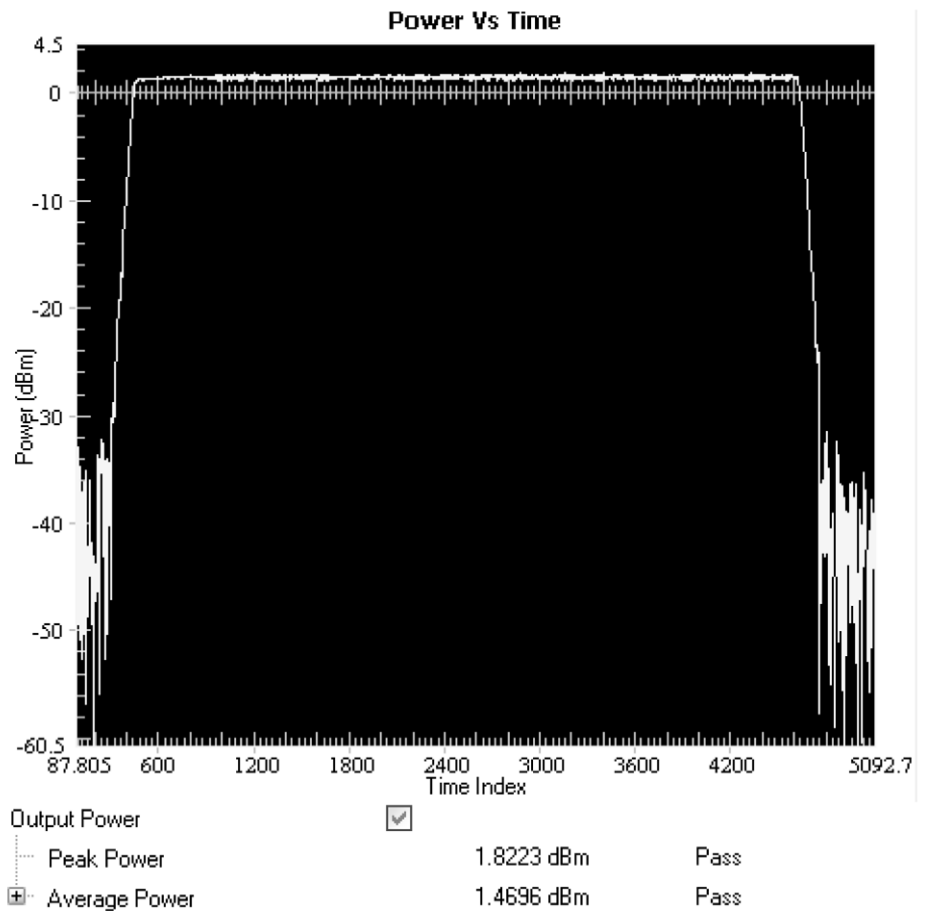

Figure 13. Agilent N4017A software display showing an output power measurement recorded using an Agilent N4010A. (Device setup: Test mode, Frequency hopping ON, DH1 packet, maximum payload length, PRBS9 as payload)

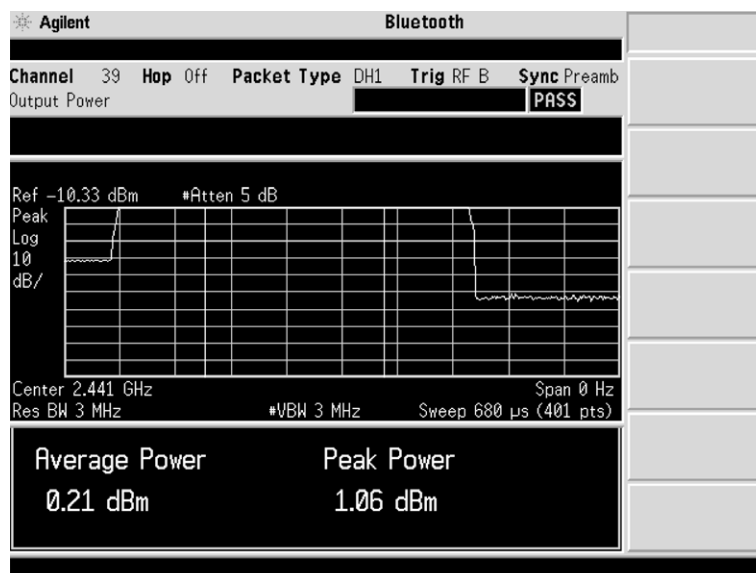

Figure 14. Agilent ESA-E series spectrum analyzer display of peak and average power measurement using the *Bluetooth* personality (Device setup: CF=2.441 GHz, sweep time 680 μs, triggering on IF ch39)

Vector signal analyzers provide a triggering delay feature to allow viewing of the burst prior to the trigger point. Vector signal analyzers also provide an average or mean power function to automatically determine the average power. Figure 15 shows a display of the average power measurement on a vector signal analyzer. The sweep time and the trigger delay are adjusted to measure the average power of the burst, while avoiding the rising and falling edges.

Power meters will be able to perform similar output power measurements for a lower cost. The Agilent power meter has a pre-defined *Bluetooth* setup stored in non-volatile memory, while its gate setup and control function allows closer analysis of the *Bluetooth* signal.

**Note:** The output power results are to be expressed in equivalent isotropically radiated power (EIRP). Since EIRP is a measure of the radiated power of the system, it includes the effects of the transmitter, cable loss, and antenna gain. When doing tests that use direct port-to-port connections, the gain of the antenna must be added to all measurements to assure that the overall system will not exceed the power output specifications.

### 2.2.2 Power density

The power density measurement provides the peak power density in a 100 kHz bandwidth. The measurement starts with the signal analyzer in the frequency domain, a center frequency in the middle of the *Bluetooth* frequency band, and a span that is wide enough to view the complete band. The resolution bandwidth is set to 100 kHz. A one-minute single sweep is performed with the trace in max hold. The peak value of the trace can be found using peak detection. This frequency becomes the analyzer's new center frequency. Figure 16 illustrates this portion of the measurement, in which the flatness error in the signal can be readily identified.

For the second part of the measurement, the analyzer is changed to the time domain and a 1-minute single sweep is performed. The power density is calculated as the average of the trace. This

calculation may be performed on a spectrum analyzer by analyzing the trace data and averaging the result. A vector signal analyzer has a utility for determining the mean power of the trace.

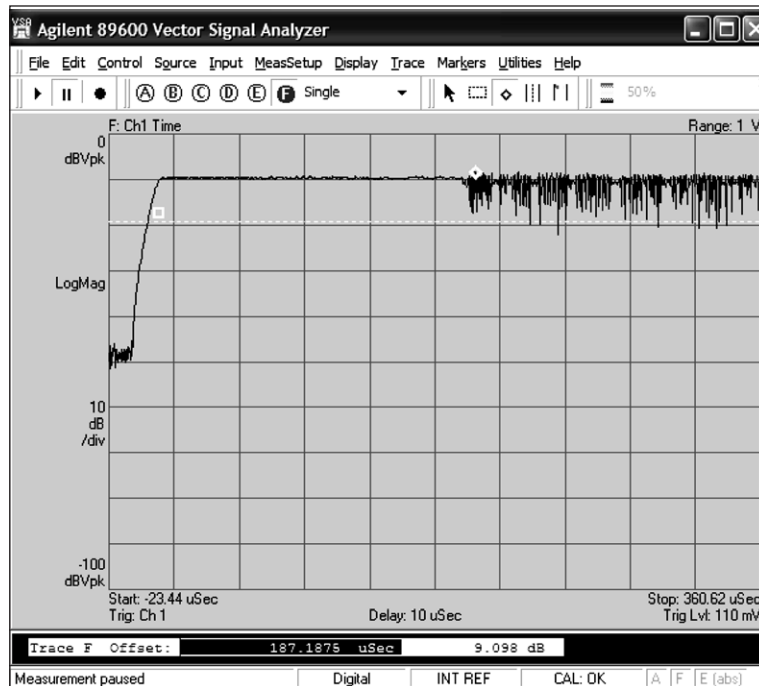

Figure 15. Agilent 89600 display of peak power measurement of a 2 Mb/s *Bluetooth* EDR packet. (Device setup: CF = 2.441 GHz, 1 dB/div, sweep time 380  $\mu$ s, triggering on IF ch 1, delay = 10  $\mu$ s)

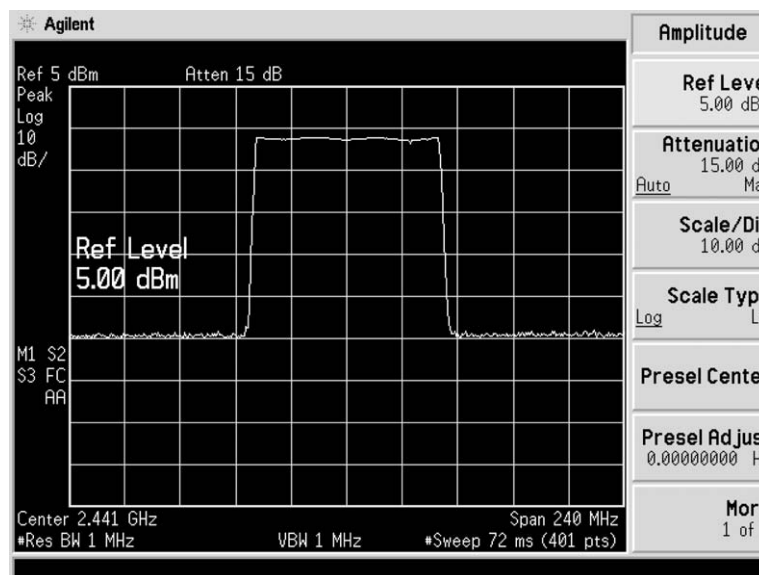

Figure 16. Agilent ESA-E display of power density measurement (Device setup: CF = 2441 MHz, span = 240 MHz, RBW = 1 MHz, VBW = 1 MHz, peak detector, trigger free run, trace on max hold, sweep time = 72 ms, continuous sweep)

### 2.2.3 Power control

Power control tests allow for testing or calibration to be performed on the level control circuitry. The power control test is only needed for devices that support power control. Power control is performed in the same manner as the average power measurement, but at three discrete frequency channels (lowest, mid, and highest operating frequency). The power control test verifies power levels and power control step sizes to ensure that they are within the specified range. With a link established, the Agilent N4010A Bluetooth test set can adjust the power level of the DUT and perform the test stand alone.

Points to note relating to power control are that all Bluetooth modules need to have a properly functioning RSSI detector, and that the signaling uses an incremental, not absolute, command.

### 2.2.4 EDR relative transmit power

EDR transmissions have both GFSK and DQPSK modulation within one packet. This test allows the device to be tested to ensure that the transmission power of each modulation type is within an acceptable range. The DUT transmits the longest supported packet type with initial settings at maximum power transmission on the lowest Tx frequency. There is no frequency hopping and the center frequency is at the DUT transmit frequency. The sweep time for the test is the length of the packet being used.

The test then calculates the average power over at least 80 percent of the GFSK and DQPSK sections of the packet. This is then repeated at the middle and highest operating frequencies. The whole procedure is repeated again on the lowest power setting of the DUT transmitter. This test can be performed using the Agilent N4010A and the N4017A GMA software. The test can also be performed using a N4010A and an 89600 vector signal analyzer as shown in Figure 17.

The output from the six pairs of tests is expected to comply with the following measurement condition:  $(P_{GFSK} - 4 \text{ dB}) \leq P_{DPSK} \leq (P_{GFSK} + 1 \text{ dB})$

### 2.3 Transmit output spectrum

The transmit output spectrum measurements analyze the power levels in the frequency domain to ensure that out-of-channel emissions are minimized. This helps reduce overall system interference and ensure regulatory compliance. The measurements compare the device's output power spectrum to a predefined mask that has the characteristics shown in Table 8.

As summarized in Table 4, the Bluetooth specification splits the test into three parts:

1. frequency range
2. -20 dB bandwidth
3. adjacent channel power

The first two tests use peak detection, while adjacent channel power uses average detection. The last two tests use a max hold mode, while frequency range uses an averaging mode.

#### 2.3.1 Frequency range

For the frequency range test, the carrier is set to the upper and lower channels. Having sampled long enough to capture the highest RF levels, a power density check is made. The signal must be below -80 dBm/Hz EIRP at 2400 MHz (or 2446.5 MHz for France) and at 2483.5 MHz.

**Table 8. Outline spectrum mask requirements**

Frequency offset	Transmit power
$M \pm [550 - 1450 \text{ kHz}]$	-20 dBc
$ M - N  = 2$	-20 dBm
$ M - N  \geq 3$	-40 dBm

Note: M is the integer channel number of the transmitting channel and N is the integer channel number of the adjacent channel that is being measured.

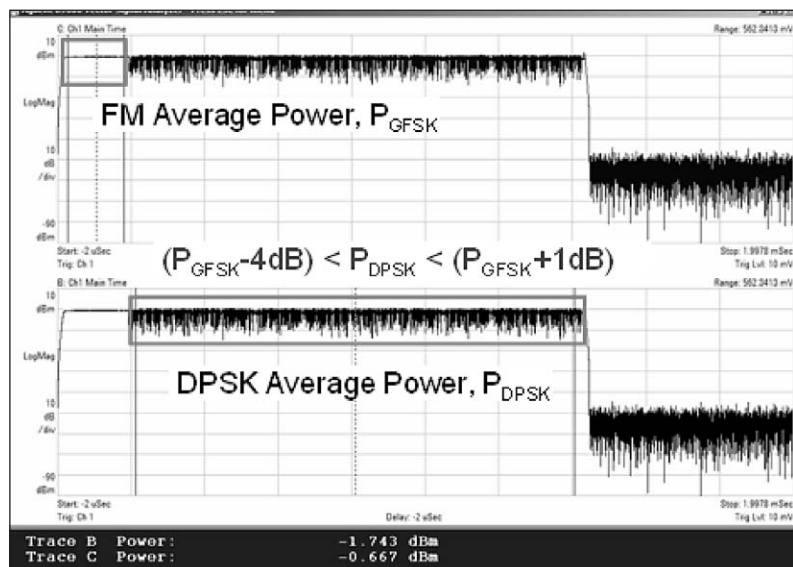

**Figure 17. Agilent 89600 vector signal analyzer showing an EDR relative transmit power measurement**



### 2.3.2 –20 dB bandwidth

Using narrower measurement filters, the –20 dB bandwidth test is performed at the lowest, middle, and highest frequency channels. Using a 2 MHz span, the peak RF level is recorded. The frequency points above and below this, where the level has dropped by 20 dB, must be less than 1 MHz apart. Figure 18 shows the type of waveform that will be observed. When viewing the output spectrum, some asymmetry on the spectral display may be noticed. This is due to the non-whitened parts of the burst, such as the header.

If an EDR signal is tested using these specifications it will fail the test since the –20 dB bandwidth is wider for a DPSK than a standard FM burst. For an EDR packet transmission the FCC has specified that the occupied bandwidth has been relaxed to 1.5 MHz for an EDR signal.

### 2.3.3 Adjacent channel power

The adjacent channel power (ACP) test is the most complex of the three measurements. Test transmissions are made on the middle channel and 3 MHz inside the upper and lower band limits – for example, channels 3 and 75. Starting with RF channel 0, ten level measurements are made at offsets from the carrier of –450 to +450 kHz. The results are summed. The measurement channel is incremented by 1 MHz and the process repeated until the top of the band is reached. As mentioned in Table 8, with the DUT transmitting on channel M and the adjacent power measured on channel N, the following conditions must be verified for compliance:

$$PTX(f) \leq -20 \text{ dBm for } |M-N| = 2$$

$$PTX(f) \leq -40 \text{ dBm for } |M-N| \geq 3$$

With a proprietary algorithm, the Agilent ESA-E spectrum analyzer provides an ACP measurement solution by pressing a single button. It makes the complex ACP measurement easy and provides an ideal tool for precompliance tests.

Figure 19 shows an ACP measurement performed for channel 3 (M = 3). The condition  $PTX(f) \leq -20 \text{ dBm}$  is checked for channel 1 and 5 (N = 1,5) and the condition  $PTX(f) \leq -40 \text{ dBm}$  is verified for the rest of the channels (N = 0,6,7,...78). The validation of this test is notified by a flag “PASS.”

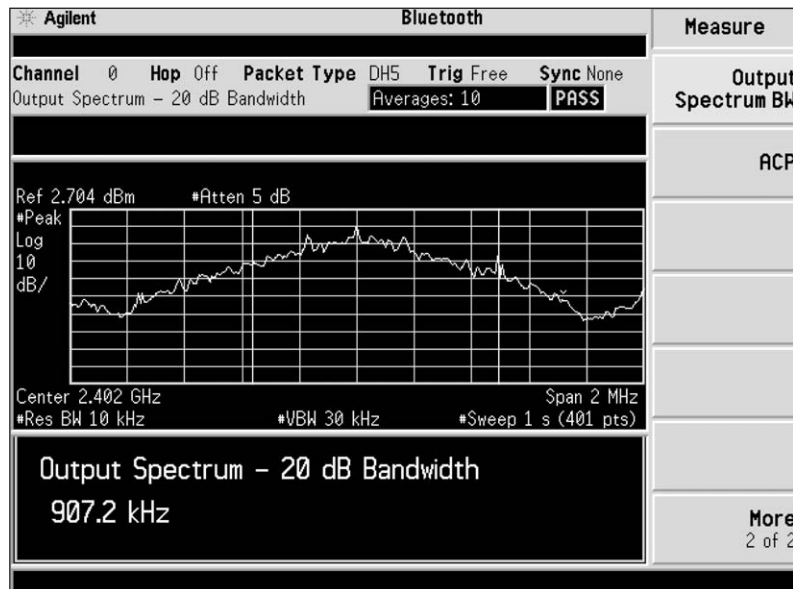

Figure 18. A –20 dB output spectrum bandwidth measurement using Agilent ESA-E with the measurement personality for Bluetooth wireless technology (Device setup: CF = 2.402 GHz, span = 2 MHz, RBW 10 kHz, VBW = 30)

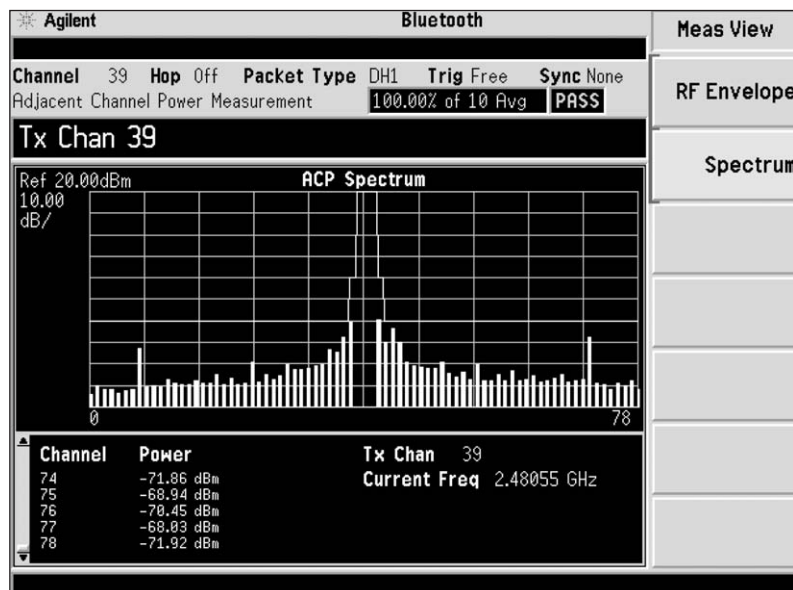

Figure 19. Agilent ESA-E series spectrum analyzer showing an ACP measurement performed on channel 39. The upper window provides an ACP spectrum (measured power versus channel) and the lower window an ACP numeric summary table listing. The latter can be extended to see the complete list of channels.

## 2.4 Modulation tests

*Bluetooth* modulation measurements consist of standard GFSK tests that measure modulation characteristics, initial carrier frequency tolerance (ICFT) and carrier frequency drift. The DPSK modulation tests consist of EDR carrier frequency stability and modulation accuracy and EDR differential phase encoding. Modulation measurements reflect the performance of the modulator circuitry as well as the stability of the local oscillator. Both the modulator and the VCO may be affected by digital noise on the power supply or by the transmit power bursts. Care is needed in the radio design to avoid frequency pulling by the power supply. Verification of modulation requires the ability to demodulate the *Bluetooth* signal so that the frequency of each bit can be determined.

### 2.4.1 Modulation characteristics

The modulation characteristics test is a frequency deviation measurement. For modulation characteristics, two sets of a repeating 8-bit sequence are used in the payload. These are 00001111 and 10101010. The combination of the two sequences checks both the modulator performance and the pre-modulation filtering. More detail can be found in the introduction of this section (Transmitter measurements) concerning the kind of stress mechanisms provided by different types of patterns.

#### Modulation characteristics process

This test procedure requires using the longest supported packets (using the longest supported payload length) and running the measurement at the lowest, middle, and highest operating frequency. For each of these three frequencies, the following process is performed for the 00001111 payload sequence and repeated for the 01010101 payload sequence:

The frequencies of each 8 bit sequence in the payload are measured and averaged together. Then the maximum deviation from the average for these bits is recorded as  $\Delta F1_{max}$  for the pattern 00001111 and as  $\Delta F2_{max}$  for the pattern 01010101. Finally, an average of the maximum deviation values is

computed and recorded as  $\Delta F1_{avg}$  for the pattern 00001111 and as  $\Delta F2_{avg}$  for the pattern 01010101. Both the maximum deviations and the average of the maximum deviations are used in the result. This procedure is performed over a period of at least 10 packets.

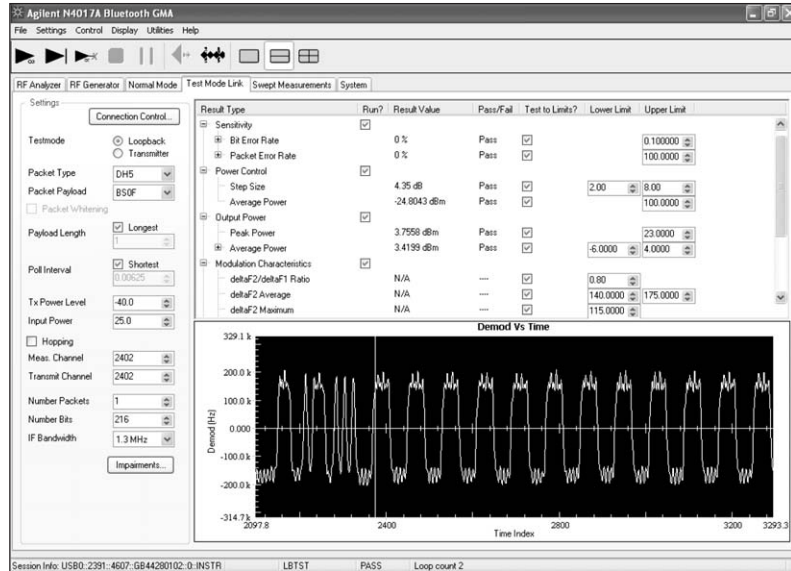

Figure 20a. Screen capture from N4017A of modulation characteristics measurement.

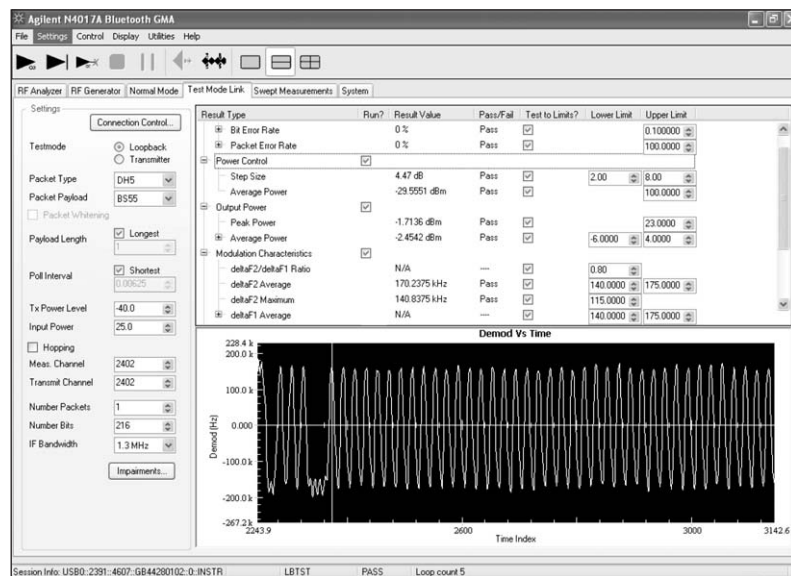

Figure 20b. Modulation characteristics measurement using N4010A *Bluetooth* test set and Agilent N4017 GMA software. (Setup: loopback mode, frequency hopping OFF, channel 0, DH5 packet, maximum payload length (339), payload pattern (00001111 for upper graph and 10101010 for lower graph.) A change of the type of payload can be done without breaking the connection with the *Bluetooth* DUT.

Then the following measurement conditions are verified to ensure the validation of the modulation characteristics:

1.  $140 \text{ kHz} \leq \Delta f_{1\text{avg}} \leq 175 \text{ kHz}$
2.  $\Delta f_{2\text{max}} \geq 115 \text{ kHz}$
3.  $\Delta f_{2\text{avg}}/\Delta f_{1\text{avg}} \geq 0.8$

The N4010A *Bluetooth* test set provides the ability to perform this test automatically. An example of a modulation characteristics measurement is shown in Figures 20a and 20b. The upper part displays a modulation graph for the payload sequence 00001111 with a calculation of  $\Delta F_{1\text{max}}$  and  $\Delta F_{1\text{avg}}$ . The lower part displays identical results for the sequence 10101010.

Similarly, by using the *Bluetooth* measurement personality for the Agilent ESA-E spectrum analyzer, this measurement can be performed in a few keystrokes. Presented with a 10101010 [F2] payload, both the maximum deviation  $\Delta F_{2\text{max}}$  and the average of the maximum deviations  $\Delta F_{2\text{avg}}$  are displayed on the screen. The result can then be stored and a burst with the 11110000 pattern can be presented to the analyzer. The measurement process is repeated with this new 11110000 [F1] payload sequence. ( $F_{1\text{max}}$  and  $F_{1\text{avg}}$  are computed and displayed. Then the ratio  $\Delta F_{2\text{avg}}/\Delta F_{1\text{avg}}$  is generated using the stored  $\Delta F_{2\text{avg}}$ . If this ratio is below 80 percent, a “FAIL” flag is displayed. Figure 21 shows a display of the Agilent ESA-E spectrum analyzer performing this modulation characteristics measurement. The ESA-E is measuring the 11110000 pattern and comparing it with the (previously stored; see “Hold result” menu) 10101010 pattern.

### 2.4.2 Modulation quality

Vector signal analyzers have the ability to provide comprehensive modulation quality measurements, which can detect, quantify, and help track down the sources of signal problems such as intermodulation due to transmitter interference, power supply noise modulation, and power and stability at antenna mismatch. Although not directly a part of the

*Bluetooth Test Specification*, modulation quality measurements such as FSK error, magnitude error, and the eye diagram are valuable troubleshooting tools. Figure 22 provides a four-display view of a demodulation measurement on a *Bluetooth* signal with frequency drift impairment. The frequency drift is easily seen in the lower left display.

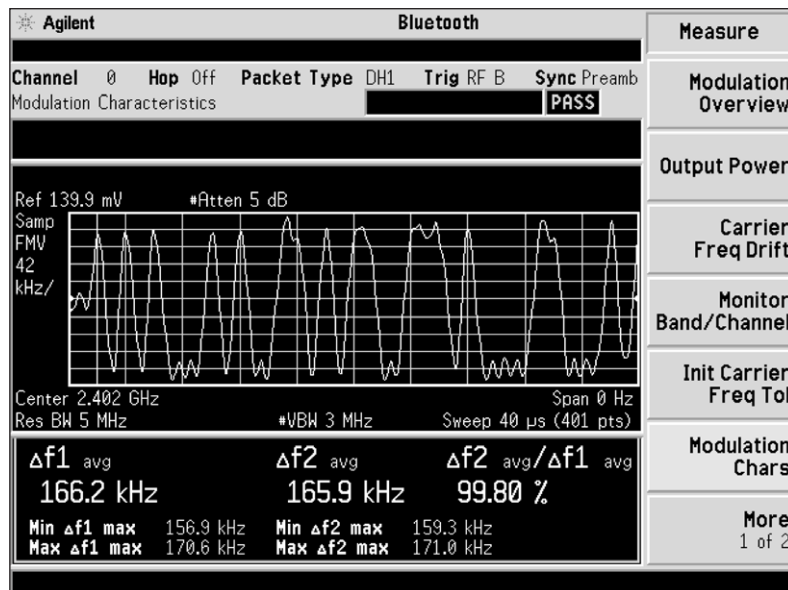

Figure 21. Agilent ESA-E series spectrum analyzer display showing the modulation characteristics measurements

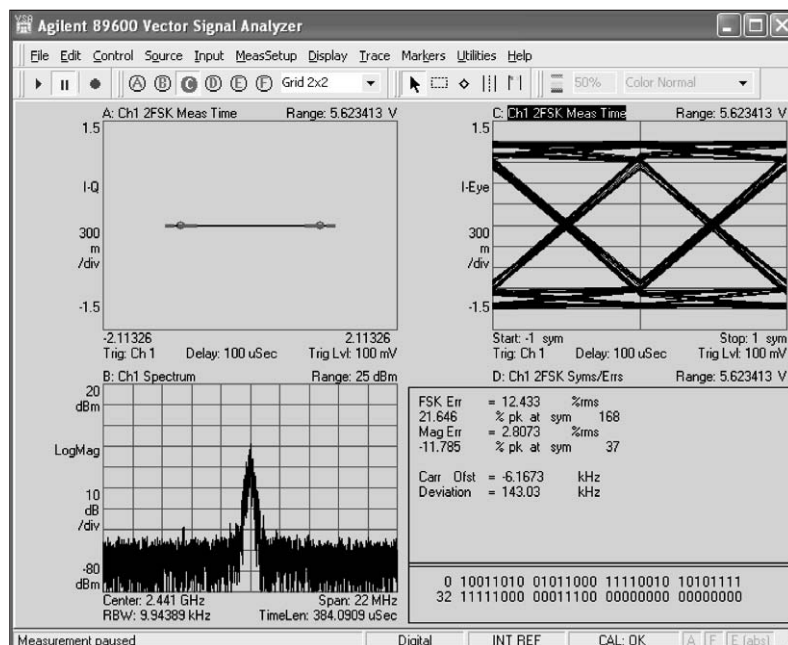

Figure 22. Agilent 89600 display of demodulation quality test

### 2.4.3 Initial carrier frequency tolerance

The initial carrier frequency tolerance test (also called frequency offset test) verifies the accuracy of the transmitter’s carrier frequency. A standard DH1 packet with a preamble and with a pseudorandom bit sequence (PRBS) as payload is used. The initial four bits of a packet, the preamble bits, are analyzed to determine the extent of the frequency deviation from center frequency. This measurement requires the signal to be demodulated to measure the frequency deviation of each symbol. After demodulation, the frequency offset of each of the preamble bits is measured and averaged.

Figure 23 shows an example of the measurement in which the first eight bits are displayed; the first four of these bits comprise the 1010 preamble. Frequency hopping is off. The test specification requires this measurement to be performed both with hopping on and with hopping off. In either case, the signal analyzer will be set to one frequency channel; however, when hopping is on, there will be the additional effect of slew as the transmitter quickly jumps from one frequency to the next. The slew may be noticed in the initial carrier frequency offset as the carrier frequency settles. The additional stress from hopping will help identify amplifier response problems.

Figure 24 shows an ICFT measurement performed with the N4010A Bluetooth test set and an N4017A GMA. This measurement requires frequency hopping to be switched on. Figure 25 shows an “Average power versus channel,” showing that the signal is hopping. A similar graph with frequency hopping off will show just one a power bar at the selected channel.

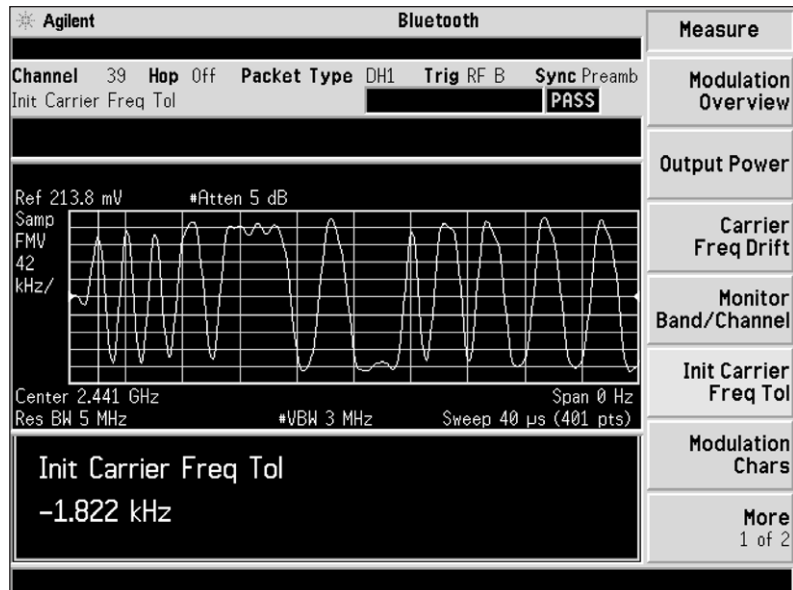

Figure 23. Agilent ESA-E series spectrum analyzer showing a –1.822 kHz offset modulation characteristic measurement

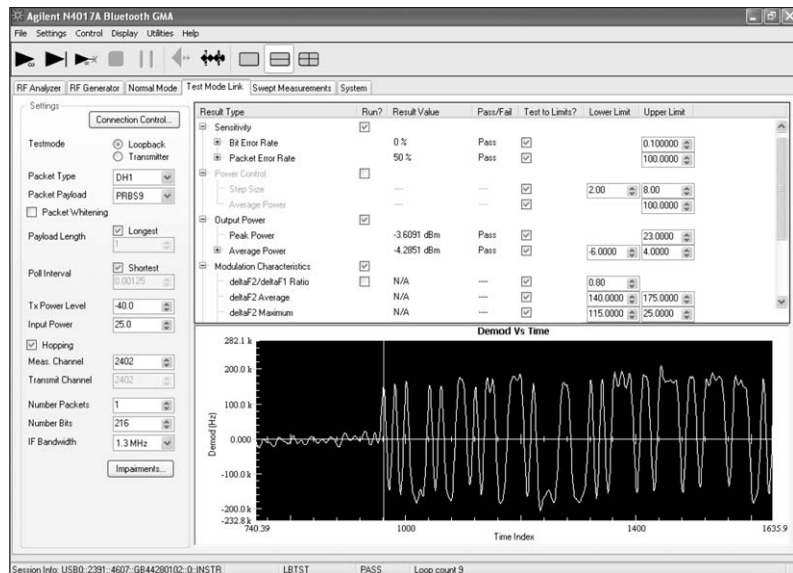

Figure 24. Agilent N4017A GMA display showing an ICFT measurement with frequency hopping on. Test mode (Transmitter mode), frequency hopping on, DH1 packet with pseudorandom bit sequence (PRBS) as payload

Both the N4010A *Bluetooth* test set and the ESA-E spectrum analyzer use the same algorithm to calculate initial carrier frequency tolerance. The Agilent N4010A can conduct the full ICFT test standalone. An alternative method of measuring ICFT to a pre-compliance level is available using Agilent 89400 and 89600 series vector signal analyzers in demodulation mode. This is a more generic method. With their result length set to the minimum number of symbols (10), these analyzers provide the carrier offset at a glance in their symbol error display. Since this minimum number of symbols is greater than four, the user may notice less variation on the result due to noise. It is important that the 0101 pattern is continued. The carrier offset result, which is provided in the summary table of the display shown in Figure 22, provides an example of this initial carrier offset measurement.

#### 2.4.4 Carrier frequency drift

Carrier frequency drift consists of verification of the transmitter center frequency drift with a packet. As the two previous tests, modulation characteristics and initial carrier frequency tolerance, carrier frequency drift is also measured as a demodulated signal (frequency versus time).

The payload data consists of a repeating 4-bit 1010 sequence. To perform the measurement, the absolute frequencies of the four preamble bits are measured and integrated; this provides the initial carrier frequency. Then the absolute frequencies of each successive 10-bit part in the payload are measured and integrated. The frequency drift is the difference between the average frequency of the four preamble bits and the average frequency of any ten bits in the payload field. The maximum drift rate is also checked, and is defined as the difference between any two adjacent 10-bit groups within the payload field.

This measurement is repeated with the lowest, middle, and highest operating frequencies, first with hopping off, then with hopping on. It is also repeated for varying packet lengths: one-slot packet (DH1), three-slot packet (DH3), and five-slot packet (DH5).

Software control makes this repetitive measurement easier. Figure 26 provides an example of a carrier frequency drift measurement using the *Bluetooth* measurement personality of the ESA-E series spectrum analyzer.

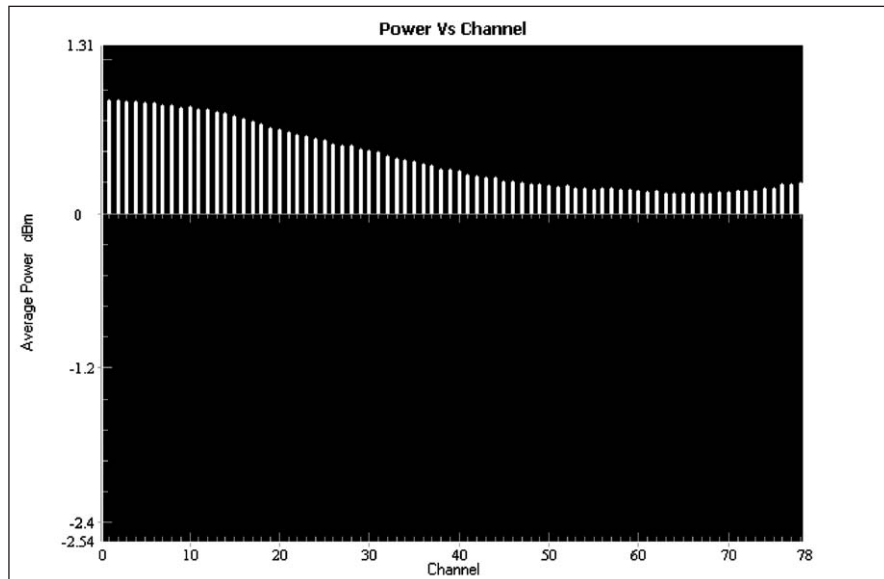

Figure 25. Agilent N4017A GMA display showing a power versus channel graph shows how the signal is hopping over 78 channels

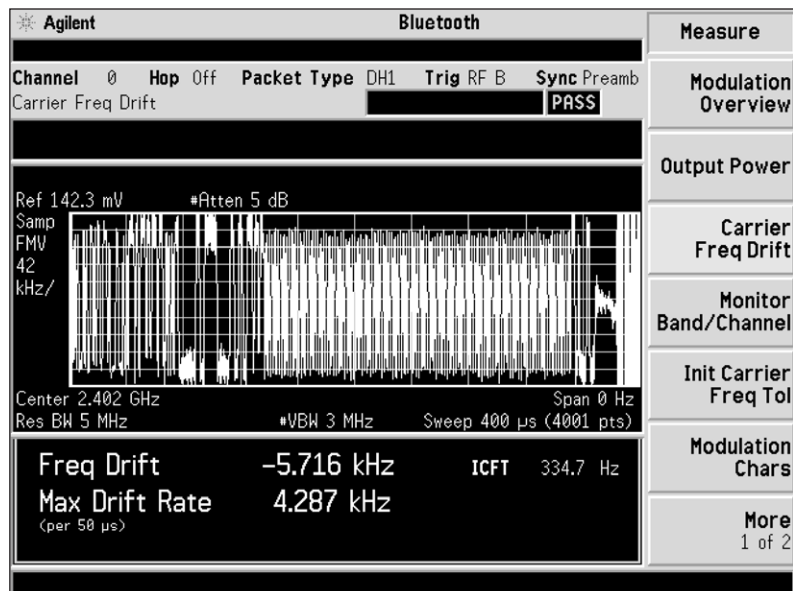

Figure 26. Agilent ESA-E spectrum analyzer display of frequency drift showing an initial carrier frequency (ICFT) of 334.7Hz, -5.716 kHz drift across the burst and 4.287 kHz maximum drift rate. (Device setup: CF = 2.402 GHz, triggered on p0 bit; F indicates maximum frequency drift limit exceeded)

As mentioned before, this carrier frequency drift test is required for three types of packets (DH1, DH3, DH5) with frequency hopping on and frequency hopping off (at the lowest, middle, and highest frequency channel). In total, the number of measurements required is 12. Obviously, this can be time-consuming. If this is an issue, “test sequencer” software may be the tool to use.

The N4010A test set is provided with such a test sequencer which has in built tests. The 12 measurements are performed in less than five seconds and each measurement is validated according to the following *Bluetooth* test specification limits:

- the transmitter center frequency is not allowed to drift more than:
  - ±25 kHz for a one-slot packet
  - ±40 kHz for a three to five-slot packet
- the maximum drift rate must be ±20 kHz/50 μs

The results can be read from the communications window of the N4010A test set. See Figure 27.

### 2.4.5 EDR carrier frequency stability and modulation accuracy

This test verifies that the modulation accuracy and the frequency stability are working within the required limits. The DUT can be in loopback mode or Tx mode. The DUT transmits the longest supported packet type depending on what modulation scheme is being used. The test starts on the lowest operating frequency and hopping is turned off for the whole test. The DUT transmits at maximum power back to the tester. To calculate the initial frequency error for a transmitted packet the test device has to run the following procedure.

The start time of the first preamble bit,  $P_0$  is determined. The frequency deviations for the header bits relative to the ideal carrier frequency are then calculated. The tester selects bits that are the same as the previous and following bits in the header. This is done to remove any inter symbol interference. The average frequency deviation of packets that represents a “one” is denoted  $\Delta\omega_1$ .  $\Delta\omega_2$  denotes the frequency deviation of the bits that represent a zero. From these two values the initial frequency error can be calculated using the formula:

$$\omega_i = (\Delta\omega_1 + \Delta\omega_2)/2$$

Once this initial error has been calculated the tester uses this to compensate for the EDR section of the packet. A square root raised cosine filter with a roll off factor of 0.4 and a 3 dB bandwidth of ±500 kHz is then applied to the enhanced data rate section of the packet.

The packet is then split into non-overlapping 50 μs which starts at the first symbol of the synchronization bit. For each block the sampling phase,  $\epsilon_0$  and frequency error,  $\omega_0$  is recorded for the root mean square (RMS) differential error vector magnitude (DEVm). Using the information calculated from

the block the DEVm is calculated for each symbol. This procedure is repeated until two hundred 50 μs blocks have been measured. This whole procedure is repeated again for middle and highest operation frequency bands. For the device to pass it must meet all the criteria specified below:

#### Carrier frequency stability:

- 75 kHz ≤  $\omega_i$  ≤ +75 kHz, for all packets
- 75 kHz ≤ ( $\omega_i + \omega_0$ ) ≤ +75 kHz, for all blocks
- 10 kHz ≤  $\omega_0$  ≤ +10 kHz, for all blocks

#### RMS DEVm

- RMS DEVm ≤ 0.20, for all π/4-DQPSK blocks
- RMS DEVm ≤ 0.13, for all 8DPSK blocks

#### Peak DEVm

- DEVm ≤ 0.35 for all π/4-DQPSK symbols
- DEVm ≤ 0.25 for all 8DPSK symbols

#### 99% DEVm

- DEVm ≤ 0.30 for 99% of π/4-DQPSK symbols
- DEVm ≤ 0.20 for 99% of 8DPSK symbols

This measurement can be performed by using the N4010A and the N4017GMA software, as shown in Figure 28.

Results > Detailed Results			
Carrier Drift			1 Slotted
	Summary	Low Medium High	3 Slotted
Min Drift (kHz)	-1.6 ✓	-2.5 ✓ -1.6 ✓ 2.5 ✓	5 Slotted
Max Drift (kHz)	7.3 ✓	7.3 ✓ 7.2 ✓ 6.5 ✓	
Max Rate (kHz)	-5.8 ✓	5.3 ✓ 5.8 ✓ -5.8 ✓	
EUT at max power			LBTST   PASS

Figure 27. Measurement and communications window of the N4010A test set showing a carrier drift rate measurement

### 2.4.6 EDR differential phase encoding

This test checks that the modulator correctly differential phase codes the data. The DUT is in Tx mode with hopping turned off. A X-DH1 or an X-EV3<sup>1</sup> packet is used depending on what modulation scheme is used. The payload of the packet is PRBS9. The EUT is set to transmit at the lowest frequency it then transmits 100 packets to the tester, which demodulates them and compares the data with the expected data. For the device to pass this test it has to have no errors in 99 percent of all the packets tested.

This test can be performed using the N4010A and N4017A software. The software has to be configured so that it sends the required number of packets to comply with the *Bluetooth* RF test specification.

## 2.5 Timing tests

Timing tests may be performed on *Bluetooth* signals; these tests include analysis of the burst profile, phase lock loop (PLL) settling time, and other timing characteristics. These tests, although not part of the specifications, help R&D engineers ensure that their designs meet the criteria of their specifications.

### 2.5.1 Burst profile

Burst rise and fall time can be measured in the time domain using a signal analyzer or a power meter. No definitions for rise time and fall times have been developed for *Bluetooth* wireless technology, although ramp-up and settling times are mandated in the *Bluetooth* RF test specification for a reference *Bluetooth* signal used for test purposes.

The conventional industry definition of rise time is the time required to rise from the 10 percent (–20 dB) amplitude point to the 90 percent (–0.9 dB) amplitude point; the fall time is defined with the same amplitude points, but in reverse. Pre-triggering allows the rise time to be easily captured and measured. There is no defined mask test for the burst profile. Some devices may exhibit considerably faster transients than that shown. Excessively fast switching will cause failures in the output spectrum test by creating increased spectrum spreading due to the sharper edges of the burst. Additional burst profile characteristics include on/off ratio of burst, overshoot, burst interval, and burst repetition frequency (see Figure 12). These characteristics can be seen in detail using the Agilent power meter analyzer software.

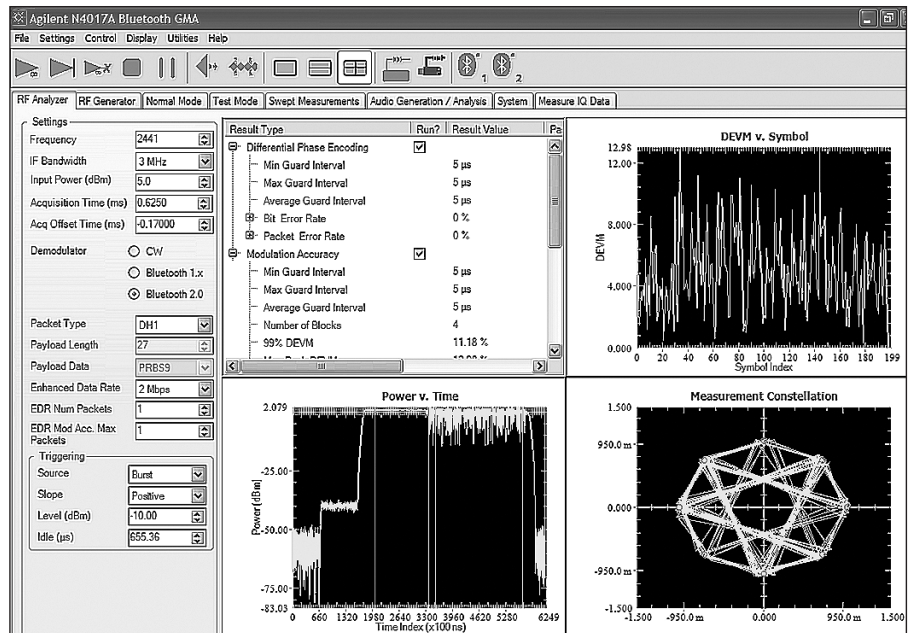

Figure 28. Display of the N4017A GMA when testing the modulation accuracy of a *Bluetooth* EDR device

1. The X is substituted for a 2 or 3 depending on which transfer rate is being used.

### 2.5.2 Spectrogram measurements

Figure 29 provides a spectrogram display in which a radio transmitter exhibits poor PLL settling time at turn-on. The spectrogram is useful in analyzing these types of conditions. The spectrogram displays frequency on the x-axis and time on the y-axis. Amplitude is displayed through colors or shades of gray with the brighter colors or shades indicating higher amplitudes.

More complex spectrograms may be created by using the time-capture capabilities of a vector signal analyzer. This allows replaying real-time data at a slower speed. Symbol timing and rate may be analyzed in this fashion. Figure 30 shows a spectrogram of a *Bluetooth* burst. The payload data in this example is 10101010 and these alternating patterns of ones and zeros can be seen either side of the center frequency. Figure 31 shows the spectrogram of an EDR burst the FM header can be seen at the start before the main ( $\pi/4$  PSK data packet that covers a large portion of the spectrum.

### 2.5.3 EDR guardband time

EDR has a guardband which starts after the header (see Figure 7) and ends at the start of the synchronization sequence. The guardband is between 4.75 and 5.25  $\mu$ s. Its purpose is to act as a buffer between the different modulation schemes in an EDR packet. To find the start of the synchronization sequence the frequency extremes are measured and averaged to find the time span that each symbol occupies. Once the time span is known the time for the start bit can be found. This is then subtracted from the time that the header finishes to give the guardband time. The guard band time can be measured using the Agilent N4010A and the N4017A GMA software. Figure 32 shows a graph from the N4017A GMA software.



Figure 29. Agilent 89441A spectrogram display for PLL settling time

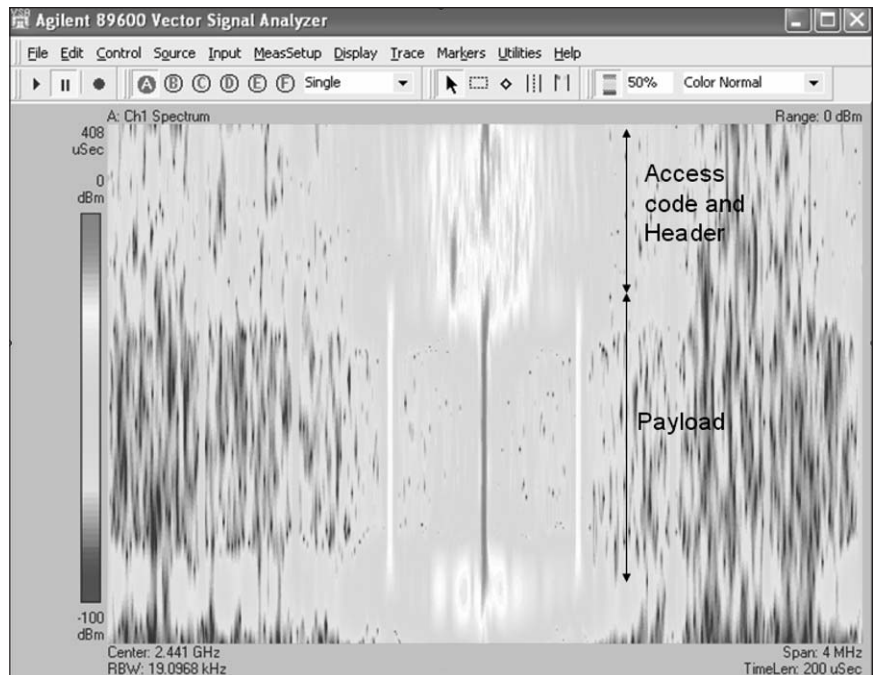

Figure 30. Agilent 89600 spectrogram display for symbol timing and rate of a DH1 packet with a 10101010 payload; the lines in the payload represent the ones and zeros



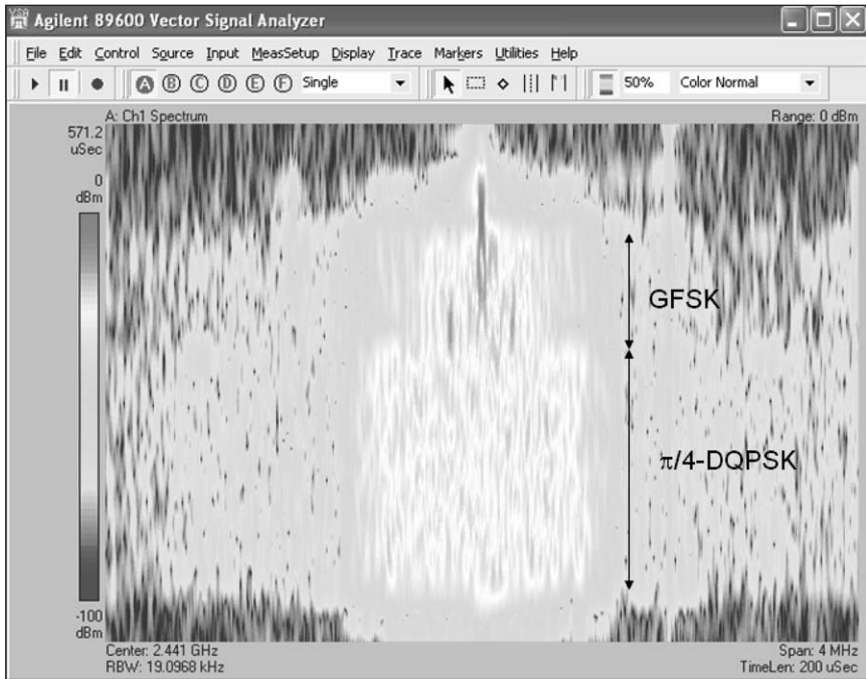

Figure 31. Agilent 89600 spectrogram display for symbol timing and rate of a EDR 2-DH1 packet; the different modulation schemes can be seen in the spectrogram

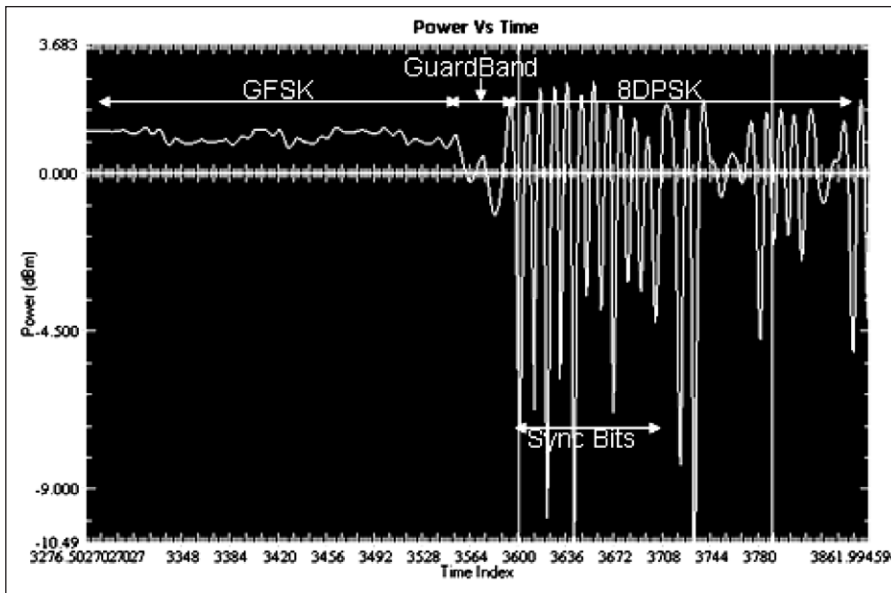

Figure 32. This shows the Agilent N4017 GMA displaying the transition between GFSK and 8DPSK modulation schemes with the guardband separating the two modulation schemes when transmitting a 3-DH5 packet

### 3. Transceiver Measurements

The transceiver measurements consist of performing some out-of-band spurious emissions tests. These out-of-band spurious emissions tests verify that the *Bluetooth* radio is operating within regulatory requirements. There are no out of band spurious emissions tests in the *Bluetooth Test Specification* it is up to the manufacturer to comply with the standard of the country where the device will be in use.

The two main tests that are used to measure out of band spurious emissions are conducted emissions and radiated emissions. Conducted emissions are a measure of the spurious emissions generated by the device under test from its antenna or output connector. Radiated emissions are a measure of the spurious emissions leakage from the cabinet of the DUT.

Separate standards are specified for the USA and Europe. The USA follows the Federal Communications Commission (FCC) part 15.247 standard. Europe follows the European Technical Standards Institute (ETSI) ETS 300 328 standard.

Spurious emissions tests can be performed using a spectrum analyzer to sweep through frequency ranges looking for spurs. The ETSI standard requires a spectrum analyzer frequency range of up to 12.75 GHz, while the FCC standard specifies a frequency range of up to 25.0 GHz. Tests requiring compliance with the International Special Committee on Radio Interference (CISPR) publication 16 may require electromagnetic compatibility (EMC) spectrum analyzers with quasi-peak detection. These tests are not covered in this application note. Contact your local Agilent sales representative for more information on Agilent EMC products.

#### 3.1 EDR in-band spurious emissions

This is a new test specified by the *Bluetooth Test Specification*. The test is used to verify that the level of unwanted signal produced within the devices frequency range is below a limit for the modulation scheme used. A spectrum analyzer such as the Agilent 89600 as shown in Figure 33 is used to measure the in band spurious emissions. This is done by using the built in emission mark test function.

The device is set to loopback or Tx mode with hopping switched off. The longest supported packet is transmitted with a PRBS9 payload. The measurements are made at 100 kHz steps between  $\pm 450$  kHz of a 1 MHz band on and around a center

frequency,  $f_c$ . The peak value of the spectrum is recorded at each 100 kHz interval and the maximum value or the averaged value of peak results is taken depending on how close the 1 MHz band is to the center frequency. Once these values have been recorded the same process is repeated over the mid and highest frequency points of the operating frequency. More detail on this test can be found in the *Bluetooth Test Specification*.

For the device to pass the test the average at 1 MHz from the center frequency must be smaller than the peak center frequency spectrum minus 26 db:

$$f_c \pm 2 \text{ MHz} < -20 \text{ dB}$$
$$f_c \pm 3 \text{ MHz} < -40 \text{ dB}$$

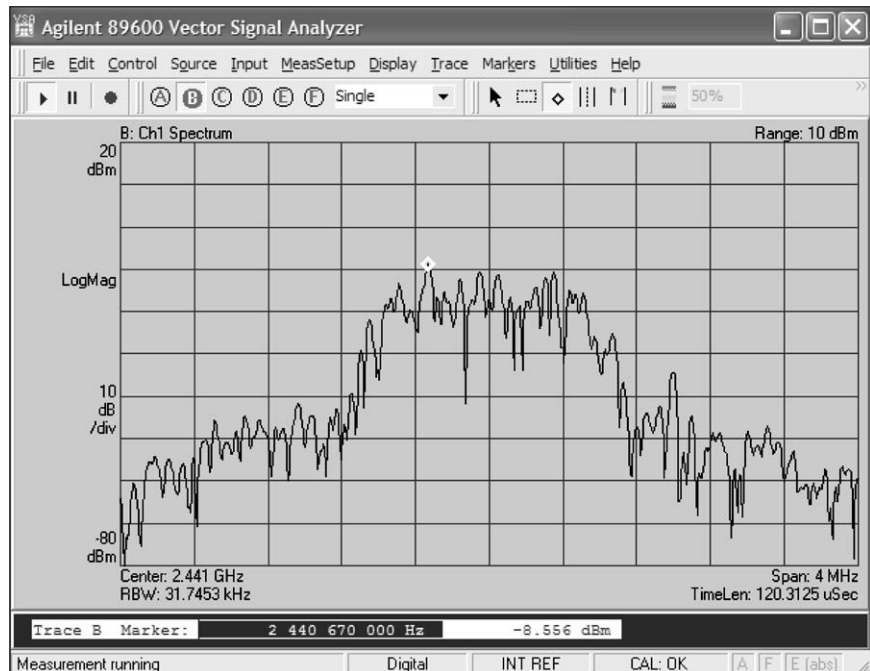

Figure 33. Agilent 89600 showing a spectrum graph which can be used to measure in band spurious emissions

## 4. Receiver Measurements

In this section, the various receiver measurements required for *Bluetooth* modules are discussed. These measurements are intended to ensure the integrity of the *Bluetooth* receiver's performance characteristics. Further detail regarding the conditions under which the receiver measurements are performed can be found in the *Bluetooth RF Test Specification*. The receiver measurements specified for *Bluetooth* wireless technology include the following:

- sensitivity - single-slot packets
- sensitivity - multi-slot packets
- carrier-to-interference (C/I) performance
- blocking performance
- intermodulation performance
- maximum input level
- EDR sensitivity
- EDR BER floor performance
- EDR C/I performance
- EDR maximum input level

Bit error rate (BER) is the criterion used to evaluate receiver performance. BER is determined by comparing transmitted and received payload data and noting the difference in bits. The ratio of the erroneous bits to the total number of bits received is the BER.

### 4.1 Test conditions and setup

#### 4.1.1 Test conditions

Table 9 is a summary of the test conditions under which receiver measurements have to be performed.

**Table 9. Receiver test parameters**

Receiver tests	Frequency hopping	Test mode	Packet type	Payload data	BER measurement
Sensitivity - Single-slot packets RCV/CA/01/C	Off On (optional)	Loopback	DH1	PRBS 9	< 0.1%
Sensitivity - Multi-slot packets RCV/CA/02/C	Off On (optional)	Loopback	DH5	PRBS 9	< 0.1%
C/I performance RCV/CA/03/C	Off	Loopback	Longest supported	PRBS 9	< 0.1%
Blocking performance RCV/CA/04/C	Off	Loopback	DH1	PRBS 9	< 0.1%
Intermodulation performance RCV/CA/05/C	Off	Loopback	DH1	PRBS 9	< 0.1%
Maximum input level RCV/CA/06/C	Off	Loopback	DH1	PRBS 9	< 0.1%
<b>EDR receiver requirements</b>					
EDR sensitivity RCV/CA/07/C	Off	Loopback	2-DHx or 2-Evx\3-DHx or 3-Evx <sup>(1)</sup>	PRBS9	< 7x10 <sup>-5</sup> (2) or < 10 <sup>-4</sup> (3)
EDR BER floor performance RCV/CA/08/C	Off	Loopback	2-DHx or 2-Evx\3-DHx <sup>(1)</sup>	PRBS9	< 7x10 <sup>-6</sup> (4) or < 10 <sup>-5</sup> (5)
EDR C/I performance TP/RCV/CA/09/C	Off	Loopback	2-DHx or 2-Evx\3-DHx <sup>(1)</sup>	PBR9	< 10 <sup>-3</sup> less than 5 times within 2 Mhz from the wanted signal
EDR maximum input level RCV/CA/10/C	Off	Loopback	2-DHx or 2-Evx\3-DHx <sup>(1)</sup>	PBR9	< 10 <sup>-3</sup>

1. The packet to be used depends on what modulation scheme is being tested number 2 prefix for  $\pi/4$  DQPSK and number 3 prefix for 8DPSK
2. After 1,600,000 data bits
3. After 16,000,000 data bits
4. After 8,000,000 data bits
5. After 160,000,000 data bits

#### 4.1.2 BER test setup

Different measurement setups can be used to perform a BER measurement. Similar to the transmitter measurement setup, a BER measurement can be performed using a *Bluetooth* standalone tester (see Figure 10), or with a test system.

A BER measurement performed with the Agilent N4010A Bluetooth test set is shown in Figure 35. A link has been established between the standalone tester and the *Bluetooth* DUT. The DUT, operating in vendor-specific loopback test mode, receives, demodulates, and decodes the incoming signal. It then re-packets the recovered payload data in the same packet type as it received and re-transmits the packet. The returned packet is then received by the *Bluetooth* test set, which performs a BER measurement. The *Bluetooth Test Specification* specifies a minimum of 1,600,000 returned payload bits to be analyzed in performing a receiver measurement.

A BER measurement can also be performed using a basic test system consisting of a signal generator with BER analysis capability and a signal analyzer with FM demodulation capability. The measurement setup is illustrated in Figure 36. For this setup, a special internal test facilities utility must be implemented in the device. This utility must have the ability to ask to the device to retransmit the packets it receives. This will allow a *Bluetooth* signal from the digital signal generator to be received, demodulated by the device's receiver, looped back through its transmitter and sent back to the spectrum analyzer. This signal will then be demodulated by the spectrum analyzer and resent to the signal generator to perform the BER measurement.

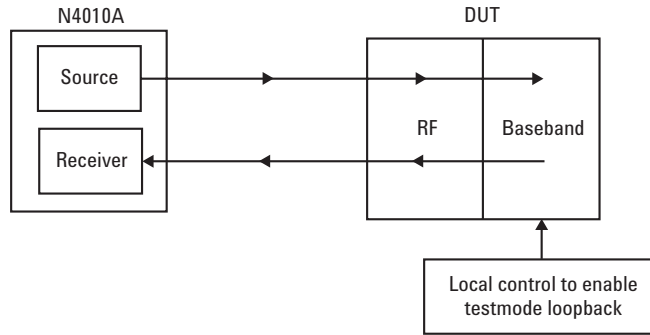

Figure 34. Test setup for performing a test in testmode loopback for a *Bluetooth* 1.x device

Results > Detailed Results			Bit Analysis
Multi-Slot Sensitivity			Packet Analysis
	Summary	Low Medium High	
BER	0.000000 ✓	---- ---- ----	Miss Pkts HEC Errors
Error Bits	0 ✓	---- ---- ----	Tx'd Pkts CRC Errors
Rx'd Bits	1600080 ✓	---- ---- ----	Len Errors NACK Pkts
			LBTST PASS
<b>EUT at max power</b>			

Figure 35. Results from an N4010A performing a BER measurement

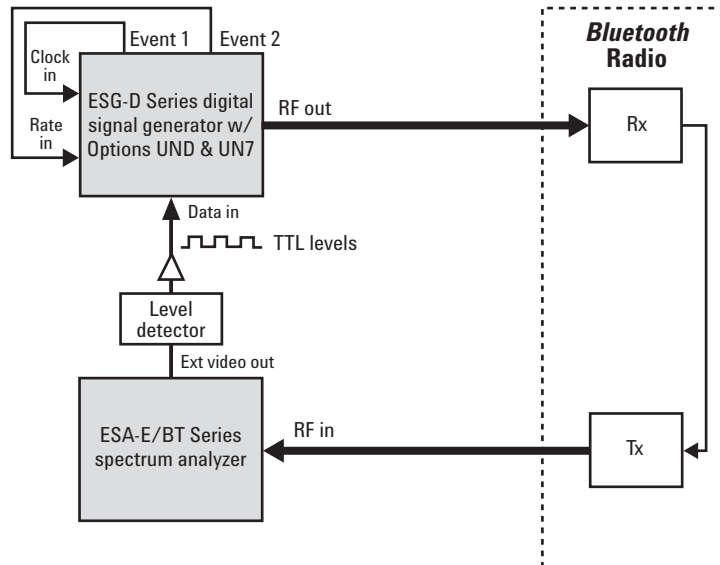

Figure 36. Example of BER measurement setup using a basic test system consisting of an Agilent ESG digital series signal generator and an ESA-E spectrum analyzer; the *Bluetooth* DUT provides an RF loopback signal

In both of the previous measurement setups, the *Bluetooth* device must have the ability to retransmit the recovered data from the received signal. It must support Loopback test mode (setup used in Figure 35) or have a loopback test facility internally implemented (setup of Figure 36). If this is not the case, a different setup must be used.

Figure 37 provides an example of a BER measurement setup in which the *Bluetooth* DUT is simply acting as a standard receiver. No loopback is performed between its receiver and its transmitter. The BER measurement is performed using the Agilent ESG-D signal generator series' internal BER analyzer (Option UN7).

The *Bluetooth* DUT receives and demodulates the signal, then provides access to the *Bluetooth* baseband signal at the baseband processor. Similar to the previous setup, the *Bluetooth* packets at the output of the baseband processor are fed to the data input of the ESG-D's internal BER analyzer (Option UN7).

As an alternative, packet error rate (PER) measurements instead of BER measurements can be made when the *Bluetooth* device does not support Loopback mode. Because

PER measurements do not require the *Bluetooth* DUT to operate in Loopback mode, they can be performed using the Bluetooth test set operating in either Transmitter test mode or in Normal mode. Although the PER measurement is not part of the Bluetooth *Test Specification*, it still provides insight into the performance of the *Bluetooth* receiver.

PER measurement is performed by the *Bluetooth* test set as follows. In transmitter (Tx) Test mode, the *Bluetooth* DUT is instructed by the *Bluetooth* test set to transmit specific packet types. This instruction is sent by the *Bluetooth* test set via POLL packets. A POLL packet has no payload and therefore consists of the channel access code and packet header only. Two situations have to be taken into account. The first one is the DUT does not receive the POLL packet (power level too low); in this case the DUT may just not transmit any Tx packet. The second situation is the DUT receives the POLL packet but does not read it correctly. For instance, it does not detect the access code of the POLL packet. In this case, the DUT will send back the corresponding Tx packet but with the acknowledgment indication bit (ARQN bit) set to NAK (negative acknowledge, ARQN = 0). As a result,

the *Bluetooth* test set will determine the PER by comparing the number of POLL packets sent with the number of Tx packets received from the DUT, and by analyzing how many Tx packets have a ARQN bit equal to 0 (NAK):

$$\text{PER\% (In Tx mode)} = \frac{100 \times [\text{number of Tx packets missing} + \text{number of Tx packets with a ARQN} = 0]}{\text{number of POLL packets sent}}$$

A similar calculation can be performed in Normal mode. In Normal mode, the test set sends some POLL packets. If the DUT receives them and reads them correctly, it will send back a NULL packet for each good reading. The PER calculation will be performed by the test set in Normal mode by comparing the number of POLL packets sent with the number of NULL packets received.

$$\text{PER\% (In Normal mode)} = \frac{100 \times [\text{number of POLL packets sent} - \text{number of NULL packets received}]}{\text{number of POLL packets sent}}$$

PER measurements can be recorded using the Agilent N4010A and N4017A GMA software in normal, test or RF analyzer mode.

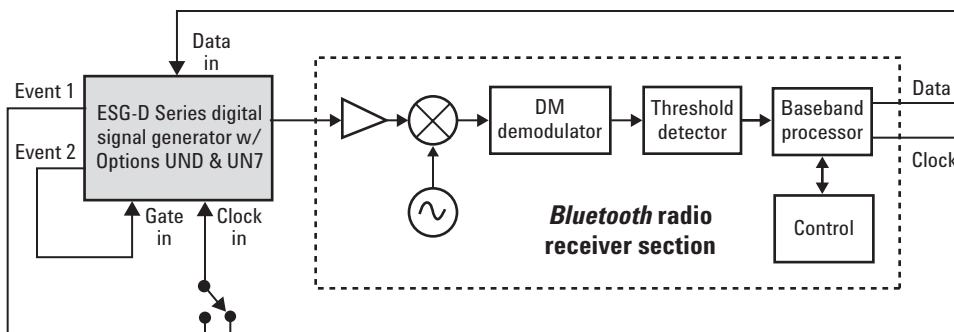

**Figure 37. Measurement setup showing how a BER measurement can be performed when the *Bluetooth* DUT receiver provides access to the *Bluetooth* baseband signal at the baseband processor output**

### 4.1.3 EDR test setup

At the time of writing, EDR performance tests do not need to operate in loopback mode. The following allowances have been made:

- non loopback testing may be used
- the DUT may be configured for test by any suitable means
- whitening may be disabled
- frequency hopping may be disabled
- the BER may be calculated by any suitable means

If the manufacturer uses any of the above test rules, it must be documented.

An example setup for testing an EDR DUT is shown in Figure 38. The packets are generated from the ARB card of the N4010A then received by the DUT. This is then checked by the application software, which compares the known packet that was sent with the packet received to calculate the error rate.

### 4.2 Sensitivity - single-slot packets

*Bluetooth* receiver sensitivity is a measure of the minimum signal level required by the receiver to produce a maximum allowed BER. Sensitivity is tested by sending a *Bluetooth* signal with various impairments to the receiver and measuring the BER of the recovered payload data. A set of ten different “dirty” transmitter packets are defined by the *Bluetooth Test Specification*, with impairments including carrier frequency offset, carrier frequency drift, modulation index, and symbol timing drift.

The Agilent N4010A automatically applies these impairments to a *Bluetooth* signal to enable automatic sensitivity testing. (See Figure 39.) To meet the specifications, the receiver’s BER must not exceed 0.1 percent when the transmit power is such that the signal level at the receiver input is  $-70$  dBm. This is

referred to as the reference sensitivity level and all *Bluetooth* receivers must meet this specification. The actual sensitivity of a *Bluetooth* receiver is the signal level required by the receiver to produce a 0.1 percent BER. The test is performed at the lowest, middle, and highest operating frequencies of the DUT.

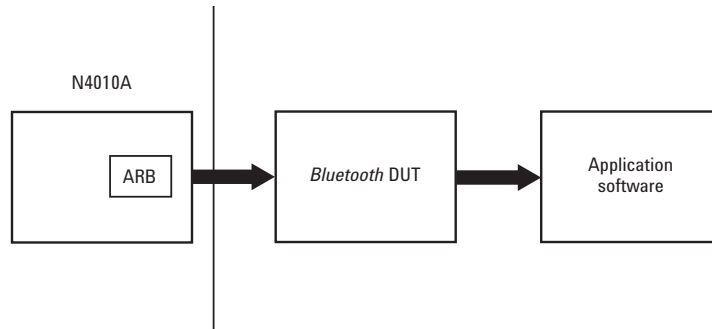

Figure 38. Test setup for measuring the EDR DUT receiver performance

Results > Detailed Results				Bit Analysis	
Single-Slot Sensitivity		Low	Medium	High	Packet Analysis
	Summary				
BER	0.001687 ✓	----	----	----	Miss Pkts HEC Errors
Error Bits	27 ✓	----	----	----	Tx'd Pkts CRC Errors
Rx'd Bits	1600128 ✓	----	----	----	Len Errors NACK Pkts
				LBTST	1/1
<b>EUT at max power</b>					

Figure 39. Measurement and communications window of the N4010A test set showing a single-slot sensitivity test; the test has a BER of less than 0.1 percent so it passes the test

### 4.3 Sensitivity - multi-slot packets

Multi-slot packet sensitivity measurement is very similar to that of single-slot packets. The key difference is that the multi-slot packet sensitivity measurement is performed using impaired DH3 or DH5 packets rather than impaired DH1 packets, as is the case with the single-slot sensitivity measurement. The longest packet type supported by the DUT is used to measure multi-slot packet sensitivity. Figure 40 shows the Agilent N4017A GMA can change the parameters of the dirty packets. The N4010A can perform this measurement automatically as the dirty packets are already configured to the Bluetooth *Test Specification*.

### 4.4 EDR sensitivity

The EDR sensitivity is tested using a non-ideal transmitter. It measures the minimum signal level required to produce a maximum value of the BER. The tester is in Loopback mode with hopping turned off. The tester sends the longest supported packets containing a PRBS 9 payload. The testers transmit power is chosen so that the input power to the DUT is -70 dBm. The packets transmitted are shown in Table 10. Each parameter is transmitted for twenty packets. Once the third parameter set has transmitted twenty packets it loops back to the first parameter set. This process continues until 1,600,000 bits have been transmitted the tester then compares the BER with the maximum allowed value of  $7 \times 10^{-5}$ . If the value is above the threshold the tester continues to send packets until 16,000,000 bits have been sent then the value is compared with the maximum value BER of  $10^{-4}$ . Once this test has finished the process is repeated at the mid, and highest operating frequency. For the DUT to pass it has to be below the BER maximum value for all frequency levels tested.

### 4.5 EDR BER floor performance

The EDR BER floor performance verifies the receiver is below the BER maximum limit for normal test conditions. The DUT is set to Loopback mode with hopping switched off. The longest supported packet type is used and the payload is PRBS9. The tester is set to transmit so that the input power to the DUT is -60 dBm. The packets are sent and returned to the tester. Once 8,000,000 bits have been transmitted the BER is compared to

the threshold value of  $7 \times 10^{-6}$ . If the BER calculated is above this value then further packets are sent until a minimum of 160,000,000 bits have been received. This is then compared with the BER Max level of  $10^{-5}$ . Once this is completed, the tester then performs the same test on the mid and highest operating frequencies. For the DUT to pass it has to be below the BER maximum value for all frequency levels tested.

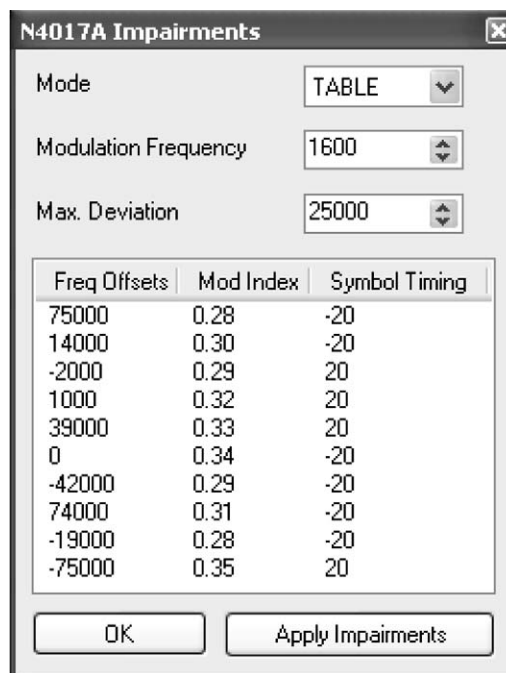

Figure 40. Agilent N4017A parameters for dirty packet transmission

Table 10. Parameters for dirty packets

Set of parameters	Carrier offset frequency	Symbol timing meter
1	0 kHz	0 ppm
2	+65 kHz	+20 ppm
3	-65 kHz	-20 ppm

## 4.6 Carrier-to-interference (C/I) performance

C/I performance is measured by sending co-channel or adjacent-channel *Bluetooth* signals in parallel with the desired signal and then measuring the receiver's BER. The interference performance on co-channel and adjacent 1 MHz and 2 MHz channels is measured with the desired signal 10 dB over the reference sensitivity level. On all other frequencies, the desired signal must be 3 dB over the reference sensitivity level.<sup>1</sup> Additional details on the structure of the interference signal are given in the *Bluetooth RF Test Specification*. The test is performed at the lowest, middle, and highest operating frequencies of the receiver, with the interfering signals at all operating frequencies within the band. The BER must be  $\leq 0.1$  percent.

The modulated interfering signal shall be continuously modulated (not bursted). This ensures 100 percent overlap of the interference and wanted signal. Figure 41 shows an

example of a setup that could be used to perform this carrier-to-interference performance test. The N4010A test set establishes communication with the *Bluetooth* DUT and provides the wanted signal, while the ESG-D digital signal generator produces a *Bluetooth* modulated interfering signal. The returned packets from the *Bluetooth* DUT are received by the *Bluetooth* test set and the BER is measured.

## 4.7 EDR carrier-to-interference (C/I) performance

This test is similar to the standard *Bluetooth* C/I performance test in that it tests how co- and adjacent-channel interference affects the signal. The tester sends out the longest supported packet with a PRBS9 payload. The DUT receives this signal at the minimum frequency level +3 MHz. The tester transmits at different powers depending on where the interference occurs. If the interference signal is on the co-channel or  $\pm 1$  MHz or  $\pm 2$  MHz on the adjacent channel, the tester transmits

at  $-60$  dBm. If the interference signal is on any other channel the tester transmits at  $-67$  dBm. The interference data is continuously modulated using PBR515 data. When co-channel measurements take place, the modulation scheme that is used is the same as the wanted signal. When adjacent channels are to be measured the modulation scheme use for the interference is GFSK. Refer to the *Bluetooth RF Test Specification* for further details about interference power levels. The BER is measured and record once 1,600,000 payload bit have been returned. The cycle is then repeated transmitting interference on all regular *Bluetooth* frequencies. Once this has been completed the tester performs the same test at the mid frequency and at the highest frequency  $-3$  MHz. Any frequencies where the BER exceeds the threshold of  $10^{-3}$  are called spurious response frequencies. For the DUT to meet the requirements to pass there must be no more than five spurious response frequencies at a distance less than 2 MHz from the wanted signal.

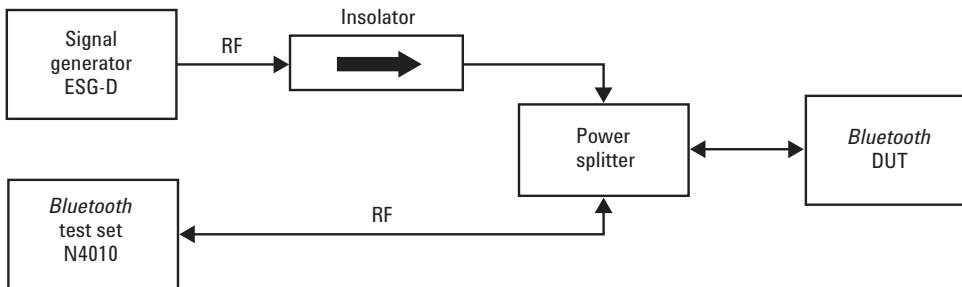

Figure 41. Example setup used to perform the carrier-to-interference (C/I) performance test

1. The reference sensitivity level is  $-70$  dBm.



## 4.8 Blocking performance

The receiver blocking performance is measured by sending a continuous wave (CW) interfering signal with the desired signal and then measuring the receiver's BER. The desired signal is transmitted at 3 dB over the reference sensitivity level<sup>1</sup> at a frequency of 2460 MHz. The CW interfering signal (blocking signal) ranges from 30 MHz to 12.75 GHz in 1 MHz increments. Within this frequency band, different power levels for the interfering signal have been defined in the *Bluetooth Test Specification*. The BER measurement, performed under the conditions described above, must be  $\leq 0.1$  percent to validate the receiver's performance in the presence of a blocking signal. The blocking performance measurement can be performed with a similar setup (see Figure 41) by replacing the ESG-D signal generator with an analog source. The Agilent Microwave Performance Signal Generator (E8247C) is ideal for this application. Its features include a step/list sweep at the frequencies and power levels required for the blocking signal.

## 4.9 Intermodulation performance

Intermodulation performance measures unwanted frequency components resulting from the interaction of two or more signals passing through a non-linear device. The desired signal is transmitted at frequency  $f_0$  with a power level 6 dB above the reference sensitivity level<sup>1</sup>. In order to create intermodulation products (3rd, 4th, and 5th order), two types of signals with power levels of  $-39$  dBm are generated. The first is a static sine wave signal at frequency  $f_1$ , while the second is a *Bluetooth* modulated signal at frequency  $f_2$ . Both signals must fulfill the following conditions:

$$f_0 = 2f_1 - f_2 \text{ and} \\ |f_2 - f_1| = n * 1 \text{ MHz, where } n \text{ can be } 3, 4, \text{ or } 5$$

The BER is then measured; any BER  $> 0.1$  percent indicates a problem in the performance of the receiver in the presence of intermodulation distortion. The setup of Figure 41 can be used to perform the intermodulation performance measurement by adding an additional interference source to provide the static sine wave signal.

## 4.10 Maximum input level

The maximum input level test measures the receiver's BER performance when the input signal is at a maximum power level specified at  $-20$  dBm. The test is performed at the lowest, middle, and highest operating frequencies. The test can be performed by the N4010A standalone as the box is preprogrammed with this test.

## 4.11 EDR maximum input level

This test is similar to the standard *Bluetooth* maximum input level. It transmits the longest supported packet with a PBR9 payload. The tester is in loopback mode with hopping off. The tester is set to transmit so that the input power to the DUT is  $-20$  dBm. The BER is recorded after at least 1,600,000 payload bits have been transmitted. Once this is completed the process is repeated for the mid and highest frequency bands. For the DUT to pass it must have a BER less than  $10^{-3}$ .

---

1. The reference sensitivity level is  $-70$  dBm.

## 5. Power Supply Measurements

---

The Bluetooth *Test Specification* specifies tests at power source voltages that are extreme for some *Bluetooth* devices.<sup>1</sup> Power supply testing, and the *Bluetooth* device's rejection of spurious signals carried on the power line, are important parts of integration testing for many applications. Measurements of power versus time during DH5 bursts and careful monitoring of the frequency error measurements are good ways to uncover power-line related problems. Agilent offers a complete line of DC power supplies that are suitable for these tests. These include general purpose supplies as well as supplies specifically designed to meet the demands of mobile communications products. These DC voltage supplies also offer low-current measuring capability, which is useful for evaluating current consumption during standby and sleep modes.

---

1. These tests are not required when the DUT is designed for operation as part of, and powered by, another system or piece of equipment.

## Appendix A: Glossary

---

**Hold mode** Power saving mode in which the device is placed in an inactive state, running only an internal timer to occasionally perform a status check.

**Information appliances** The category of information-focused devices that provide voice or data to the user. Examples are not limited to, but include cellular phones, personal digital assistants (PDAs), and digital cameras.

**Master unit** The device in a piconet whose clock and hopping sequence are used to synchronize all other devices in a piconet.

**Packet** A single bundle of information transmitted within a piconet. A packet is transmitted on a frequency hop and nominally covers a single time slot, but may be extended to cover up to five slots.

**Park mode** Power-saving mode in which the device is placed in an inactive state. The device is synchronized to the piconet but does not participate in the traffic. Park mode provides the highest power efficiency.

**Payload** The user's voice or data information, which is carried in a packet.

**Piconet** The piconet is the smallest *Bluetooth* network structure. A piconet consists of one master and up to seven actively communicating or 200+ inactive non-communicating slaves. The piconet is defined by its hopping sequence.

**Power saving mode** Three power saving modes exist: sniff mode, hold mode, and park mode. Each of these modes puts the slave unit in varying states of sleep. No data is transferred to or from a slave unit while it is in a power saving mode.

**Pretriggering** A feature which allows examination of the waveform at a point in time prior to the defined trigger point.

**Scatternet** A net formed by multiple independent and non-synchronized piconets. Devices can share piconets.

**Slave units** All devices in a piconet that are not the master. Slave units may be in active mode, in which they are actively communicating with the master, or they may be in an inactive sleep mode.

**Sniff mode** Power-saving mode in which the device listens to the piconet at a reduced rate to conserve power. Sniff mode is the least efficient power-saving mode.

**Standby mode** The state of a *Bluetooth* unit which is not connected to a piconet. In this mode, devices listen for messages every 1.28 seconds.

## Appendix B: Symbols and Acronyms

---

<b>2FSK</b>	2-level frequency shift keying; also known as binary FSK	<b>EDR</b>	enhanced data rate	<b>LM</b>	link manager software
<b>ACL</b>	asynchronous connection less link	<b>EIRP</b>	equivalent isotropically radiated power (effective isotropic radiated power)	<b>LMP</b>	link manager protocol
<b>ACP</b>	adjacent channel power	<b>EMC</b>	electromagnetic compatibility	<b>LO</b>	local oscillator
<b>ARB</b>	arbitrary waveform generator	<b>ETSI</b>	European Technical Standards Institute	<b>PAN</b>	personal area network
<b>ARQ</b>	automatic repeat request error correction scheme for data	<b>EVM</b>	error vector magnitude	<b>PDA</b>	personal digital assistant
<b>BT(BbT)</b>	bandwidth-time product	<b>FCC</b>	Federal Communications Commission	<b>PER</b>	packet error rate
<b>BER</b>	bit error rate	<b>FEC</b>	forward error correction	<b>PLL</b>	phase lock loop
<b>CF</b>	center frequency	<b>FHSS</b>	frequency hopping spread spectrum	<b>PN9</b>	pseudorandom noise of period $2^9 - 1$ bits
<b>C/I</b>	carrier-to-interference	<b>FSK</b>	frequency shift key	<b>PRBS</b>	pseudo random bit sequence
<b>CISPR</b>	International Special Committee on Radio Interference	<b>GFSK</b>	Gaussian-filtered frequency shift keying	<b>PSD</b>	power spectral density
<b>CW</b>	continuous wave	<b>GMA</b>	graphical measurement application	<b>PSK</b>	phase shift keying
<b>dBc</b>	decibels relative to the carrier frequency	<b>GSM</b>	global system for mobile communications	<b>RBW</b>	resolution bandwidth
<b>dBi</b>	decibels relative to an isotropic radiator in free space	<b>Hz</b>	Hertz or cycles/second	<b>RMS</b>	root mean square
<b>dBm</b>	decibels relative to 1 milliwatt ( $10\log(\text{power}/1\text{mW})$ )	<b>ICFT</b>	initial carrier frequency tolerance	<b>RSSI</b>	receiver signal strength indicator
<b>DECT</b>	digital enhanced cordless telecommunication	<b>IF</b>	intermediate frequency	<b>RF</b>	radio frequency
<b>DEVm</b>	differential error vector magnitude	<b>ISM</b>	industrial, scientific, and medical radio band	<b>SCO</b>	synchronous connection-oriented link
<b>DPSK</b>	differential phase shift keying			<b>SIG</b>	<i>Bluetooth</i> Special Interest Group
<b>DQPSK</b>	differential quadrature phase shift keying			<b>TDD</b>	time division duplex
<b>DUT</b>	device under test			<b>VBW</b>	video bandwidth
				<b>VCO</b>	voltage controlled oscillator
				<b>VSA</b>	vector signal analyzer

## Appendix C: Recommended Reading for *Bluetooth*

---

The following documents are accessible via the Agilent *Bluetooth* Web site: [www.agilent.com/find/bluetooth](http://www.agilent.com/find/bluetooth)

*Verifying Bluetooth Baseband Signals using Mixed Signal Oscilloscopes*, application note AN 1333-3, literature number 5988-2181EN

*Agilent E4438C Signal Signal Studio for Bluetooth*, application note 1421, literature number 5988-5417EN

*Agilent Wireless Connectivity Testing*, brochure, literature number 5988-4438EN

*Agilent N4010A Wireless Connectivity Test Set*, data sheet, literature number 5989-0251EN

Agilent N4017A Graphical Measurement Application, product overview, literature number 5989-2771EN

*Agilent Innovative Solutions for Testing Bluetooth Enhanced Data Rate Products*, product overview, literature number 5989-3055EN

*Agilent Bluetooth Measurement Solution for the ESA-E Series Spectrum Analyzers*, product overview, literature number 5980-2786EN

*Agilent ESA-E Series Spectrum Analyzer Bluetooth Measurement Option, Self-Guided Demo*, product note, literature number 5980-2577EN

*Agilent EPM-P Series Single- and Dual-Channel Power Meters Demo Guide*, literature number 5988-1605EN

*Agilent Vector Signal Analysis Basics*, application note 150-15, literature number 5989-1121EN

### Generic RF recommended reading

*8 Hints for Making Better Measurements Using RF Signal Generators*, application note 1306-1, literature number 5967-5661E

*8 Hints for Making Better Spectrum Analyzer Measurements*, application note 1286-1, literature number 5965-7009E

*Cookbook for EMC Precompliance Measurements*, application note 1290-1, literature number 5964-2151E

*Measuring Bit Error Rate using the Agilent ESG-D Series RF Signal Generators Option UN7*, literature number 5966-4098E

*Spectrum Analysis Basics*, application note 150, literature number 5952-0292

*Testing and Troubleshooting Digital RF Communications Receiver Designs*, application note 1314, literature number 5968-3579E

*Testing and Troubleshooting Digital RF Communications Transmitter Designs*, application note 1313, literature number 5968-3578E

*Fundamentals of RF and Power Measurement*, (four parts) literature numbers 5988-9213EN, 5988-9214EN, 5988-9215EN, 5988-9216EN

*Agilent 89600 Series Wide Bandwidth Vector Signal Analyzers*, literature number 5980-0723E

*Agilent ESG Family of RF Signal Generators*, configuration guide, literature number 5965-4973E

## Appendix D: Agilent Solutions for *Bluetooth* Wireless Technology

Agilent equipment for *Bluetooth* testing

O = Meets fully-specified *Bluetooth* test requirements

A = Meets fully-specified *Bluetooth* test requirements when combined with other test equipment

X = Not fully compliant to *Bluetooth* test requirements; pre-compliance testing only

<b>Bluetooth RF layer test cases</b>	<b>N4010A Bluetooth test set<sup>6</sup></b>	<b>N4017A Bluetooth GMA and N4010A<sup>6,7</sup></b>	<b>ESA-E Series spectrum analyzers</b>	<b>86900 vector signal analyzer<sup>2</sup></b>	<b>P-Series or EPM-P Series power meters</b>	<b>E4438C ESG signal generator<sup>1</sup></b>
<b>Transmitter tests</b>						
Output power [TRM/CA/01/C]	O	O	O <sup>9</sup>	O	O	
Power density [TRM/CA/02/C]			O	O		
Power control [TRM/CA/03/C]	O	O	O <sup>9</sup>	O	O	
Tx output spectrum-frequency range [TRM/CA/04/C]			O	O		
Tx output spectrum –20 dB bandwidth [TRM/CA/05/C]			O <sup>9</sup>	O		
Tx output spectrum-adjacent channel power [TRM/CA/06/C]			O <sup>9</sup>	O		
Modulation characteristics [TRM/CA/07/C]	O	O	O <sup>9</sup>			
Initial carrier frequency tolerance [TRM/CA/08/C]	O	O	O <sup>9</sup>	O		
Carrier frequency drift [TRM/CA/09/C]	O	O	O <sup>9</sup>	O		
<b>EDR</b>						
EDR relative transmit power [TRM/CA/10/C]	O	O	O	O		
EDR carrier frequency stability and modulation accuracy [TRM/CA/11/C]	O	O				
EDR differential phase encoding [TRM/CA/12/C]	O	O				
<b>Receiver tests</b>						
Sensitivity/single-slot packets [RCV/CA/01/C]	O	O				X
Sensitivity/multi-slot packets [RCV/CA/02/C]	O	O				X
C/I performance [RCV/CA/03/C]	A <sup>3</sup>	A <sup>3</sup>				A <sup>3</sup>
Blocking performance [RCV/CA/04/C]	A <sup>4</sup>	A <sup>4</sup>				A <sup>4</sup>
Intermodulation performance [RCV/CA/05/C]	A <sup>5</sup>	A <sup>5</sup>				A <sup>5</sup>
Maximum input level [RCV/CA/06/C]	O	O				O
<b>EDR receiver test</b>						
EDR sensitivity [RCV/CA/07/C]	O	O				
EDR BER floor performance [RCV/CA/08/C]	O	O				
EDR carrier-to-interference (C/I) performance [TP/RCV/CA/09/C]	A <sup>8</sup>	A <sup>8</sup>				
EDR maximum input level [RCV/CA/10/C]	O	O				
<b>EDR transceiver test</b>						
EDR in-band spurious emissions [TRM/CA/13/C]				O	O	

1. Used with Signal Studio for *Bluetooth* devices.

2. 89600 Series vector signal analysis software can be used with a variety of digitizers including: PSA and ESA-E spectrum analyzers, N4010A wireless connectivity test set, oscilloscopes, logic analyzers, and VXI.

3. The C/I performance receiver test requires an additional signal source with *Bluetooth* capability such as the N4010A or the ESG for the interfering signal.

4. The blocking performance receiver test requires a *Bluetooth* modulated source such as the N4010A or ESG and a microwave signal source such as the E8257D to generate the interfering signal (30 MHz to 12.75 GHz).

5. The intermodulation performance receiver test requires two *Bluetooth* modulated sources such as the N4010A or ESG and one CW source such as the ESG or the E8257D to generate intermodulation.

6. N4010A-101 required for *Bluetooth* 1.2 standard tests. N4010A-101 and -107 required for EDR tests.

7. N4017A-205 required for EDR test coverage.

8. The EDR C/I performance receiver test requires an additional signal source with *Bluetooth* EDR capability such as the N4010A Option 105 EDR Tx/Rx.

9. ESA *Bluetooth* Option 228 required.

## Appendix E: References

---

1. Bluetooth *Test Specification* - RF, Part A, For Specification 2.0, Revision 2.0, March 21, 2005 - *Bluetooth SIG*

2. *Specification of the Bluetooth System* – Version 2.0 + EDR, Volume 0, November 4, 2004 – *Bluetooth SIG*

3. The Official *Bluetooth* Web site, [www.bluetooth.com](http://www.bluetooth.com). Includes information on *Bluetooth* history, technology, news, specifications, applications, products, events, and *Bluetooth* Special Interest Group (SIG). The *Bluetooth* SIG-Members area web site, [www.bluetooth.org](http://www.bluetooth.org) provides access to the Bluetooth *Test Specification*, announcements, and pre-release specifications. This Web site is password protected for some technical documents.



### Agilent Email Updates

[www.agilent.com/find/emailupdates](http://www.agilent.com/find/emailupdates)

Get the latest information on the products and applications you select.



### Agilent Direct

[www.agilent.com/find/quick](http://www.agilent.com/find/quick)

Quickly choose and use your test equipment solutions with confidence.



[www.agilent.com/find/open](http://www.agilent.com/find/open)

Agilent Open simplifies the process of connecting and programming test systems to help engineers design, validate and manufacture electronic products. Agilent offers open connectivity for a broad range of system-ready instruments, open industry software, PC-standard I/O and global support, which are combined to more easily integrate test system development.

**LXI** is the US registered trademark of the LXI Consortium.

*Bluetooth* is a registered trademark owned by Bluetooth SIG, Inc., U.S.A. and licensed to Agilent Technologies, Inc.

## Remove all doubt

Our repair and calibration services will get your equipment back to you, performing like new, when promised. You will get full value out of your Agilent equipment throughout its lifetime. Your equipment will be serviced by Agilent-trained technicians using the latest factory calibration procedures, automated repair diagnostics and genuine parts. You will always have the utmost confidence in your measurements.

Agilent offers a wide range of additional expert test and measurement services for your equipment, including initial start-up assistance onsite education and training, as well as design, system integration, and project management.

For more information on repair and calibration services, go to

[www.agilent.com/find/removealldoubt](http://www.agilent.com/find/removealldoubt)

## www.agilent.com

For more information on Agilent Technologies' products, applications or services, please contact your local Agilent office. The complete list is available at:

[www.agilent.com/find/contactus](http://www.agilent.com/find/contactus)

### Phone or Fax

#### United States:

(tel) 800 829 4444  
(fax) 800 829 4433

#### Canada:

(tel) 877 894 4414  
(fax) 800 746 4866

#### China:

(tel) 800 810 0189  
(fax) 800 820 2816

#### Europe:

(tel) 31 20 547 2111

#### Japan:

(tel) (81) 426 56 7832  
(fax) (81) 426 56 7840

#### Korea:

(tel) (080) 769 0800  
(fax) (080) 769 0900

#### Latin America:

(tel) (305) 269 7500

#### Taiwan:

(tel) 0800 047 866  
(fax) 0800 286 331

#### Other Asia Pacific Countries:

(tel) (65) 6375 8100  
(fax) (65) 6755 0042  
Email: [tm\\_ap@agilent.com](mailto:tm_ap@agilent.com)

Revised: 09/14/06

Product specifications and descriptions in this document subject to change without notice.

© Agilent Technologies, Inc. 2006, 2005, 2001

Printed in USA, October 12, 2006  
5988-3760EN



Agilent Technologies