

## Errata

**Title & Document Type:** 83620A and 83622A Synthesized Sweepers Calibration

**Manual Part Number:** 08360-90024Ed6

**Revision Date:** October 1991

---

### HP References in this Manual

This manual may contain references to HP or Hewlett-Packard. Please note that Hewlett-Packard's former test and measurement, semiconductor products and chemical analysis businesses are now part of Agilent Technologies. We have made no changes to this manual copy. The HP XXXX referred to in this document is now the Agilent XXXX. For example, model number HP8648A is now model number Agilent 8648A.

### About this Manual

We've added this manual to the Agilent website in an effort to help you support your product. This manual provides the best information we could find. It may be incomplete or contain dated information, and the scan quality may not be ideal. If we find a better copy in the future, we will add it to the Agilent website.

### Support for Your Product

Agilent no longer sells or supports this product. You will find any other available product information on the Agilent Test & Measurement website:

[www.tm.agilent.com](http://www.tm.agilent.com)

Search for the model number of this product, and the resulting product page will guide you to any available information. Our service centers may be able to perform calibration if no repair parts are needed, but no other support from Agilent is available.

---

HP 83620A/22A Synthesized Sweepers  
**Calibration Manual**

**SERIAL NUMBERS**

This manual applies to any synthesized sweeper with the following model number and serial number prefix combinations. You may have to modify this manual so that it applies *directly* to your instrument version. Refer to the "Instrument History" chapter.

**HP 83620A/22A**

3143A  
3119A  
3108A  
3104A  
3102A  
3050A  
3044A  
3036A



HP Part No. 08360-90024  
Printed in USA October 1991

Edition 6

# HP 8360 SERIES DOCUMENTATION MAP CALIBRATION MANUAL

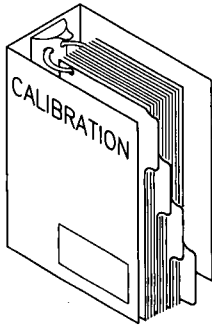

INDEX  
GLOSSARY

**5 MENUS**

Menu Maps.

**4 AUTOMATED TESTS**

Software—Run Performance Tests and Adjustments.  
Front Panel Emulator Instructions.

Calibration Constants

**3 ADJUSTMENTS**

Adjusting Instrument After Repair.  
Adjusting Instrument After Performance Test Failure.

Operation Verification

**2 PERFORMANCE TESTS**

Incoming Inspection.  
Testing Instrument to Specifications.  
Testing Instrument after Repair.

**1 EQUIPMENT REQUIRED**

Equipment for Performance Tests.  
Equipment for Adjustments.

CONTENTS  
PREFACE

**MORE MAPS**

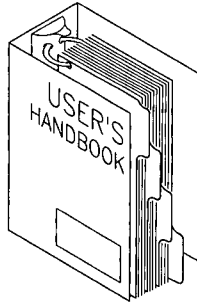

FRONT PANEL AND PROGRAMMING REFERENCE

**4 OPERATOR'S CHECK ROUTINE MAINTENANCE**

Checking Instrument Operation.  
Cleaning Fan Filter.  
Changing Fuses.  
Cleaning the Display.

**3 INSTALLATION**

Unpacking the Instrument.  
Option Definitions.  
Compatibility.  
Instrument Storage.  
Packing the Instrument.  
Environmental Requirements.  
Fuses and Line Cords.  
Accessories Supplied.  
Touch-Up Paint.

**2 OPERATING & PROGRAMMING REFERENCE**

Softkey Definitions.  
Hardkey Definitions.  
Error Messages.  
Menu Maps.  
Specifications.

**1 GETTING STARTED**

Front Panel Operation.  
Remote Operation (Programming).  
Operating and Programming Applications.  
Operating and Programming Examples.

**7 OPTION RETROFITS**

Retrofits Available.

**6 PREVENTIVE MAINTENANCE**

Cleaning the Fan Filter.  
Replacing a Fuse.  
Cleaning the Display.

**5 MENUS & SELF TESTS**

Menu Maps.  
Running instrument Self Tests.

**4 REPLACEABLE PARTS**

Assembly Part Numbers.  
Hardware Part Numbers.  
Documentation Part Numbers.  
Module Exchange Program Information.  
Instrument Touch-Up Paint.

**3 POST-REPAIR**

List of Adjustments After a Repair.  
List of Performance Tests After a Repair.

**2 DISASSEMBLY & REPLACEMENT PROCEDURES**

Replacing Difficult Assemblies.

**1 TROUBLESHOOTING**

Isolating a Faulty Assembly.

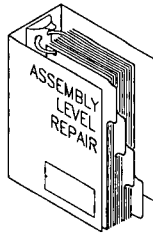

## **EXCLUSIVE REMEDIES**

THE REMEDIES PROVIDED HEREIN ARE BUYER'S SOLE AND EXCLUSIVE REMEDIES. HP SHALL NOT BE LIABLE FOR ANY DIRECT, INDIRECT, SPECIAL, INCIDENTAL, OR CONSEQUENTIAL DAMAGES, WHETHER BASED ON CONTRACT, TORT, OR ANY OTHER LEGAL THEORY.

## **Assistance**

*Product maintenance agreements and other customer assistance agreements are available for Hewlett-Packard Products.*

*For any assistance, contact your nearest Hewlett-Packard Sales and Service Office. Addresses are provided at the back of this manual.*



PREFACE



---

## Preface

### Instruments Covered By This Manual

This manual applies to HP 83620A/22A synthesized sweepers having a serial number prefix listed on the title page (behind the “Documentation Map” tab). Some changes may have to be made to this manual so that it applies directly to each instrument; refer to “Instrument History” to see what changes may apply to your instrument.

A serial number label (see figure i) is attached to the instrument’s rear panel. A prefix (four digits followed by a letter), and a suffix (five digits unique to each instrument), comprise the instrument serial number.

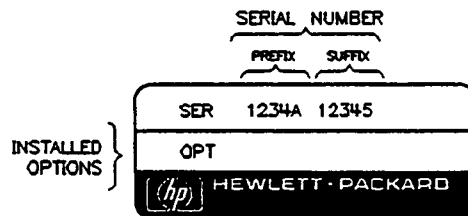

**Figure i. Typical Serial Number Label**

An instrument’s prefix that is not listed on the title page may indicate that the instrument is different from those documented in this manual. For serial number prefixes before those listed on the title page, refer to *HP 8360 Series Synthesized Sweepers Instrument History* (to order, see “Replaceable Parts” in *Assembly-Level Repair*).

## **How to Order Manuals**

A manual part number and microfiche part number are listed on the title page of this manual. Use either to order extra copies of this manual. Also listed are the documentation sets that include this manual.

Microfiche are 10 by 15 cm (4 by 6 in.) microfilm transparencies. Each microfiche contains reduced photocopies of the manual pages.

See "Replaceable Parts" for a complete list of documentation and ordering numbers.



---

## Safety Considerations

### General

This product and related documentation must be reviewed for familiarization with safety markings and instructions before operation. This product has been designed and tested in accordance with international standards.

### Safety Symbols



Instruction manual symbol: the product will be marked with this symbol when it is necessary for the user to refer to the instruction manual (refer to Table of Contents).



Indicates hazardous voltages.



Indicates earth (ground) terminal.

---

### Warning



The **WARNING** sign denotes a hazard. It calls attention to a procedure, practice, or the like, which, if not correctly performed or adhered to, could result in personal injury. Do not proceed beyond a **WARNING** sign until the indicated conditions are fully understood and met.

---

---

**Caution**

The CAUTION sign denotes a hazard. It calls attention to an operating procedure, practice, or the like, which, if not correctly performed or adhered to, could result in damage to or destruction of part or all of the product. Do not proceed beyond a CAUTION sign until the indicated conditions are fully understood and met.

---

**Safety Earth Ground**

This is a Safety Class I product (provided with a protective earthing terminal). An uninterruptible safety earth ground must be provided from the main power source to the product input wiring terminals, power, cord, or supplied power cord set. Whenever it is likely that the protection has been impaired, the product must be made inoperative and secured against any unintended operation.

**Before Applying Power**

Verify that the product is configured to match the available main power source per the input power configuration instructions provided in this manual.

If this product is to be energized via an autotransformer make sure the common terminal is connected to the neutral (grounded side of the mains supply).

**Servicing**

*Any servicing, adjustment, maintenance, or repair of this product must be performed only by qualified personnel.*

*Adjustments described in this manual may be performed with power supplied to the product while protective covers are removed. Energy available at many points may, if contacted, result in personal injury.*

*Capacitors inside this product may still be charged even when disconnected from their power source.*

*To avoid a fire hazard, only fuses with the required current rating and of the specified type (normal blow, time delay, etc.) are to be used for replacement.*



**CONTENTS**



# HP 83620A AND 83622A SYNTHESIZED SWEEPERS

## TABLE OF CONTENTS

### SECTION 1. EQUIPMENT REQUIRED

Required Test Equipment Table	1-1
-------------------------------	-----

### SECTION 2. PERFORMANCE TESTS

How to Use this Chapter	2-1
Menus	2-1
Operator's Check	2-2
Operation Verification	2-2
Automated Performance Tests	2-2
Equipment Required	2-2
Test Record	2-2
Test Sequence	2-2
Calibration Cycle	2-2
1. Internal Timebase: Aging	
Rate Test	2-5
2. Swept Frequency Accuracy Test	2-9
3. Frequency Switching Time Test	2-13
4. Power Accuracy Test	2-19
5. Power Flatness Test	2-23
6. Maximum Leveled Power Test	2-25
7. External Leveling Test	2-29
8. Spurious Signals (Harmonic) Test	2-31
9. Spurious Signals (Non-Harmonic) Test	2-35
10. Spurious Signals (Line-Related) Test	2-39
11. Single Sideband Phase Noise Test	2-43
12. Pulse Modulation On/Off Ratio Test	2-49
13. Pulse Performance Test	2-53
14. Pulse Modulation Video Feedthrough Test	2-59
15. AM Accuracy Test	2-65
16. AM Bandwidth Test	2-69
17. AM Dynamic Range Test	2-73
18. FM Accuracy Test	2-81
19. FM Bandwidth Test	2-85
20. Maximum FM Deviation Test	2-89
21. Internal Pulse Accuracy (Option 002)	2-95
22. Modulation Meter (Option 002) Test Record	2-97

### OPERATION VERIFICATION

Introduction	2-107
Menus	2-107
The Operation Verification Form	2-107
1. Self-Tests	2-107
2. Power Accuracy	2-108
3. Power Flatness	2-108
4. Maximum Leveled Power	2-108
Operation Verification Form	2-109

### SECTION 3. ADJUSTMENTS

How to Use this Chapter	3-1
Menus	3-1
Equipment Required	3-2
Cautions and Warnings	3-2
1. 10 MHz Standard Adjustment	3-3
2. Fractional-N VCO Adjustment	3-7
3. Fractional-N Reference and API Spurs Adjustment	3-9
4. Sweep Ramp Adjustment	3-13
5. Sampler Assembly Adjustment	3-15
6. YO Driver +10V Reference Adjustment	3-21
7. YO Driver Gain and Linearity Adjustment	3-23
8. YO Loop Gain Adjustment	3-25
9. Amplifier Detector Offset Adjustment	3-27
10a. SYTM Adjustments	3-29
10b. SYTM Adjustments Option 006	3-53
11. Low Power SRD Bias Adjustment	3-77
12. Amplifier Detector Gain Adjustment	3-81
13. Modulator Offset and Gain Adjustment	3-83
14. ALC Power Level Accuracy Adjustment	3-87
15. Power Flatness Adjustment	3-91
16. Modulation Generator	3-93
17. AM Accuracy Adjustment	3-95
18. AM Delay Adjustment	3-99

19. Pulse Delay Adjustment .....	3-101
20. FM Gain Adjustment .....	3-105
21. Square Wave Symmetry Adjustment .....	3-109
22. AM Input Impedance .....	3-111
23. FM Input Impedance .....	3-113
24. Modulation Generation Flatness .....	3-115

### **CALIBRATION CONSTANTS**

Introduction .....	3-119
Definition .....	3-119
Memory Areas .....	3-120
Working Data .....	3-120
Protected Data .....	3-120
Default Data .....	3-120
Checksum Verification .....	3-121
Calibration Constant Password .....	3-121
Entering a Password .....	3-121
Disabling a Password .....	3-122
Setting a Password .....	3-123
Bypassing the Password .....	3-123
Changing Working Data Calibration Constants .....	3-124
Saving Working Data Calibration Constants .....	3-125
Loading Protected Data Calibration Constants .....	3-125
Loading Default Data Calibration Constants .....	3-126
Calibration Constant Descriptions .....	3-126
Calibration Constant Descriptions Table .....	3-128

### **SECTION 4. AUTOMATED TESTS**

Introduction .....	4-1
Setting Up the System .....	4-2
Hardware Requirements .....	4-2
Operating System Requirements .....	4-2
Installing the Software .....	4-3

Disk Files .....	4-3
Make Working Copies .....	4-3
Installing Program to a Hard Disk .....	4-3
Operating From a Floppy Disk .....	4-4
Double- to Single-Sided Disk Conversion .....	4-4
Running the Software .....	4-5
Configuration Limitations .....	4-5
Loading the Software .....	4-5
Loading Single-Sided Formatted Disks .....	4-6
Reporting Software Bugs .....	4-7
Automated Performance Tests .....	4-8
1. Step Attenuator Flatness Test .....	4-8
2. Power Flatness and Accuracy Test .....	4-10
Automated Adjustments .....	4-12
1. Step Attenuator Flatness Adjustment .....	4-12
2. YO Delay Adjustment .....	4-14
3. ADC Adjustment .....	4-14
4. Power Flatness Adjustment .....	4-15
Utilities .....	4-17
1. Front Panel Emulation .....	4-17
2. Calibration Constants .....	4-20
3. Self-Test .....	4-21
4. Power Sensor Configuration and Calibration Factor File .....	4-21

### **SECTION 5. MENUS**

ALC Menu .....	1
Frequency Menu .....	2
Marker Menu .....	3
Modulation Menu .....	4
Power Menu .....	5
Service Menu .....	6
Sweep Menu .....	7
System Menu .....	8
User Cal Menu .....	9

**1 EQUIPMENT REQUIRED**

**Table 1-1. Required Test Equipment**

Instrument	Critical Specifications	Recommended Model	Use <sup>1</sup>
Spectrum Analyzer		HP 8566B <sup>2</sup>	Swept Frequency Accuracy (P) Spurious Signals (Harm. & Subharm.) (P) Spurious Signals (Non-harmonics) (P) Spurious Signals (Line Related) (P) Pulse Modulation On/Off Ratio (P) AM Dynamic Range (P) FM Accuracy (P) Maximum FM Deviation (P) Fractional-N Reference and API Spurs (A) FM Gain (A)
Analog Oscilloscope	A vs B Sweep Mode Vertical Sensitivity: 5 mV/Div Bandwidth: 100 MHz	HP 1740A	SYTM Adjustments (A)
Local Oscillator (Synthesized Sweeper)		HP 83620/ HP 8340A/B <sup>2</sup>	Pulse Performance (P) Pulse Modulation Video Feedthrough (P)
Spectrum Analyzer with Tracking Generator	Frequency Range: 20 Hz to 5 MHz	HP 3585A/B	AM Bandwidth (P) FM Bandwidth (P)
Controller	4 Mbyte RAM BASIC 5.1 HP-IB	HP 9836/HP 9920/ HP 310/HP 320	Step Attenuator Flatness (AP) Power Flatness and Accuracy (AP) Step Attenuator Flatness (AA) YO Delay (AA) ADC (AA) Power Flatness (AA)

1 A - Manual Adjustment AA - Automated Adjustment AP - Automated Performance Test P - Manual Performance Test

2 Recommended model is part of the microwave test station.

Table 1-1. Required Test Equipment (continued)

Instrument	Critical Specifications	Recommended Model	Use <sup>1</sup>
Software	No Substitute (Included in this manual)	HP P/N 08360-10001	Step Attenuator Flatness (AP) Power Flatness and Accuracy (AP) Step Attenuator Flatness (AA) YO Delay (AA) ADC (AA) Power Flatness (AA)
DVM	Range: -50 to +50 VDC Accuracy: $\pm 0.01\%$ Input Impedance: $\geq 10\text{ M}\Omega$	HP 3456A <sup>2</sup> HP 3457A	External Leveling (P) AM Accuracy (P) AM Dynamic Range (P) FM Bandwidth (P) AM Delay (A) Pulse Delay (A) ADC (AA)
Digital Oscilloscope	Dual Channel Bandwidth: DC to 300 MHz Input Impedance: $1\text{ M}\Omega$ and $50\text{ M}\Omega$ Vertical Sensitivity: $\leq 5\text{ mV/Div}$ Horizontal Sensitivity: $50\text{ ns/Div}$ Trigger: Event Triggerable	HP 54110A/ HP 54111D <sup>2</sup>	Internal Timebase: Aging Rate (P) Swept Frequency Accuracy (P) Frequency Switching Time (P) Pulse Performance (P) Pulse Modulation Video Feedthrough (P) Internal Pulse Accuracy (P) FM Bandwidth (P) 10 MHz Standard (A) Low Power SRD Bias (A) Modulator Offset and Gain (A) Modulation Generator Flatness (A)
Oscilloscope Probes	Division Ratio: 10:1	HP 10431A	Swept Frequency Accuracy (P) Frequency Switching Time (P) Pulse Modulation Video Feedthrough (P) SYTM Adjustments (A) Low Power SRD Bias (A) Modulator Offset and Gain (A)
Oscilloscope Probes	Division Ratio: 1:1	HP 10437A	Pulse Accuracy (P)



Table 1-1. Required Test Equipment (continued)

Instrument	Critical Specifications	Recommended Model	Use <sup>1</sup>
Pulse Generator	Pulse Width: $\leq 50$ ns Rise Time: $\leq 10$ ns Frequency: 10 Hz to 5 MHz	HP 8112B/HP 8116A <sup>2</sup>	Pulse Performance (P) Pulse Modulation Video Feedthrough (P) Pulse Delay (A)
Function Generator	Frequency Accuracy: $\pm 5 \times 10^{-6}$ Amplitude Accuracy 100 kHz to 1 MHz: $\pm 0.1$ dB 100 kHz to 20 MHz: $\pm 0.4$ dB	HP 3325A	AM Accuracy (P) AM Dynamic Range (P) FM Accuracy (P) FM Bandwidth (P) Maximum FM Deviation (P) Modulation Meter (P) AM Accuracy (A) AM Delay (A) FM Gain (A)
Function Generator	Amplitude Range: $> 16$ V p-p	HP 8111A	Maximum FM Deviation (P)
Power Meter	Power Range: 1 $\mu$ W to 100 mW Accuracy: $\pm 0.02$ dB	HP 436A HP 437A HP 438A	Power Accuracy (P) AM Dynamic Range (P) SYTM Adjustments (A) ALC Power Level Accuracy (A) AM Accuracy (A) FM Gain (A)
Power Meter	Power Range: 1 $\mu$ W to 100 mW Accuracy: $\pm 0.02$ dB	HP 437A	Power Flatness (P) Power Flatness (A)
Power Meter	Power Range: 1 $\mu$ W to 100 mW Accuracy: $\pm 0.02$ dB	HP 438A	Power Flatness and Accuracy (AP) Power Flatness (AA) Step Attenuator Flatness (AA) Step Attenuator Flatness (AP)
Power Sensor	Frequency Range: 10 MHz to 2.3 GHz Power Range: 1 $\mu$ W to 100 mW	HP 8482A	Power Flatness (P) Power Flatness (A) Step Attenuator Flatness (AP) Power Flatness and Accuracy (AP) Step Attenuator Flatness (AA) Power Flatness (AA)

Table 1-1. Required Test Equipment (continued)

Instrument	Critical Specifications	Recommended Model	Use <sup>1</sup>
Power Sensor	Frequency Range: 50 MHz to 20 GHz Power Range: 1 $\mu$ W to 100 mW	HP 8485A	Power Accuracy (P) Power Flatness (P) AM Dynamic Range (P) SYTM Adjustments (A) ALC Power Level Accuracy (A) Power Flatness (A) AM Accuracy (A) Square Wave Symmetry (A) Power Flatness and Accuracy (AP) Power Flatness (AA) Step Attenuator Flatness (AA) Step Attenuator Flatness (AP)
Power Sensor	Frequency Range: 50 MHz to 20 GHz Power Range: 100 pW to 10 $\mu$ W	HP 8485D	Step Attenuator Flatness (AA) Step Attenuator Flatness (AP)
Attenuator	Attenuation: 30 dB $\pm$ 0.05 dB at 50 MHz	HP 11708A	Step Attenuator Flatness (AA) Step Attenuator Flatness (AP)
Frequency Standard	Frequency: 10 MHz Stability: $> 1 \times 10^{-10}/yr$	HP 5061A	Internal Timebase: Aging Rate (P) 10 MHz Standard (A)
Measuring Receiver	Frequency Range (tuned): 2.5 MHz to 1.3 GHz Range: 0 dBm to -127 dBm Relative Power Accuracy: $\pm$ 0.5 dB AM Rates: 20 Hz to 100 kHz Depth: to 99% Accuracy: $\pm$ 1% of reading $\pm$ 1 count	HP 8902A <sup>2</sup>	AM Accuracy (P)
Phase Noise Measurement System	Frequency Range (carrier): 0.01 to 18 GHz Sensitivity: < -70 dBc at 100 Hz offset < -78 dBc at 1 kHz offset < -86 dBc at 10 kHz offset < -107 dBc at 100 kHz offset Offset Frequency Range: 100 Hz to 2 MHz Amplitude Accuracy: $\pm$ 2 dB to 1 MHz offset	HP 3048A	Single Sideband Phase Noise (P)

**Table 1-1. Required Test Equipment (continued)**

Instrument	Critical Specifications	Recommended Model	Use <sup>1</sup>
Microwave Amplifier	Frequency Range: 1.5 to 18 GHz Leveled Output Power: $\geq 16$ dBm	HP 8349B	FM Bandwidth (P)
Preamplifier/ Power Amplifier	Frequency Range: 100 kHz to 1.3 GHz Preamplifier Gain: 25 dB Power Amplifier Gain: 22 dB	HP 8447F	Pulse Performance (P) Pulse Modulation Video Feedthrough (P)
Delay Line Discriminator	$\geq 1$ meter	HP P/N 08505-20038	FM Bandwidth (P)
Mixer	Frequency Range: 1 GHz to 20 GHz	HP P/N 0955-0307	Pulse Performance (P) AM Accuracy (P) FM Bandwidth (P)
Power Splitter	Frequency Range: 10 MHz to 20 GHz	HP 11667B	FM Bandwidth (P)
Crystal Detector	Frequency Range: DC to 20 GHz Maximum Input: 200 mW Polarity: Negative	HP 33330D	AM Bandwidth (P)
Attenuator	Frequency Range: 10 MHz to 20 GHz Maximum Input Power: 300 mW Attenuation: 6 dB	HP 8493C Opt 006	Pulse Performance (P) Pulse Modulation Video Feedthrough (P)
Attenuator	Frequency Range: 10 MHz to 20 GHz Maximum Input Power: 300 mW Attenuation: 10 dB	HP 8493C Opt 010	Pulse Performance (P) FM Bandwidth (P) SYTM Adjustments (A) Step Attenuator Flatness (AA) Step Attenuator Flatness (AA)
Attenuator	Frequency Range: 10 MHz to 20 GHz Maximum Input Power: 300 mW Attenuation: 20 dB	HP 8493C Option 020	Maximum Leveled Power (P)
3.7 GHz Low Pass Filter		HP P/N 9135-0191	Pulse Modulation Video Feedthrough (P)
130 MHz Bessel Low Pass Filter		K & L Microwave 5LL30-130/BT2400/BP	Pulse Modulation Video Feedthrough (P)

**Table 1-1. Required Test Equipment (continued)**

Instrument	Critical Specifications	Recommended Model	Use <sup>1</sup>
Tool Kit	No Substitute	HP P/N 08360-60060	
Invertron		California Instruments 501TC	Spurious Signals (Line Related) (P)
Ground Isolator		HP 11356A	Spurious Signals (Line Related) (P)
Capacitor		1000 pf	HP P/N 0160-4574

The following list of adapters and cables is provided for convenience. They may be used in equipment setups for performance tests or adjustments.

SMA (m) to SMA (m) adapter	1250-1159
SMA (f) to SMA (f) adapter	1250-1158
SMB (m) to SMB (m) adapter	1250-0669
SMB (f) to SMB (f) adapter	1250-0672
SMB tee (f) (m) (m)	1250-1391
3.5 mm (f) to 3.5 mm (f) adapter	5061-5311
3.5 mm (f) to N-type (m) adapter	1250-1745
2.4 mm (f) to 2.92 mm (f) adapter	1250-2187
2.4 mm (f) to 2.4 mm (f) adapter	1250-2188
2.4 mm (m) to 3.5 mm (f) adapter	11901C
BNC (f) to BNC (f) adapter	1250-0080
BNC (m) to BNC (m) adapter	1250-0216
BNC (f) to SMA (m) adapter	1250-1200
BNC (f) to SMB (m) adapter	1250-1237
BNC tee (m) (f) (f)	1250-0781
SMB (f) to BNC (m) flexible cable	85680-60093
SMA semi-rigid cable 2 feet	08340-20124
BNC male cable 2 feet	8120-3446
BNC cable	8120-2582

## **2 PERFORMANCE TESTS**

## 2. HP 8360 Series Performance Tests

---

### HOW TO USE THIS CHAPTER

Use the procedures in this chapter to test the electrical performance of the synthesizer. These tests (listed in table 2-1) do not require access to the interior of the instrument.

#### Note



The synthesizer must warm up for at least *one hour* before the electrical specifications are valid.

#### Note



In all cases where you are instructed to preset the synthesizer, use the factory preset mode only.

#### Menus

If you are not familiar with the menus in this instrument, go to the "MENUS" chapter and fold out the menu maps (see the following figure).

Some menus have more than one page of softkeys. Select the *[more]* softkey to view the next page of softkeys. *[more]* is *not* included in the keystrokes given in these procedures.

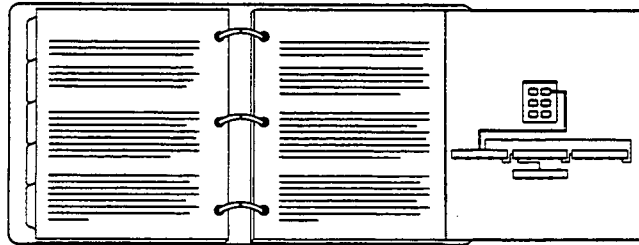

## **OPERATOR'S CHECK**

For assurance that most of the internal functions of the instrument work (without testing for specifications), see "Operator's Check," in the *User's Handbook*.

## **OPERATION VERIFICATION**

To meet the needs of most incoming inspections (80% verification), and provide a reasonable assurance that the instrument works, see the "Operation Verification" section of this chapter.

## **AUTOMATED PERFORMANCE TESTS**

The automated performance tests available at time-of-shipment are included in the "AUTOMATED TESTS" chapter of this manual.

## **EQUIPMENT REQUIRED**

The equipment required to perform the tests in this chapter is listed in the "EQUIPMENT REQUIRED" chapter of this manual. You may use any equipment that meets the critical specifications given.

## **TEST RECORD**

Test records are supplied at the end of this chapter. Use a test record when you perform a full calibration of your synthesizer. This form provides a tabulated index of the performance tests, their acceptable limits, and a column to record actual measurements.

### **Note**



There may be more than one test record. Be sure you use the one designated (at the top) for your synthesizer.

## **TEST SEQUENCE**

Perform the tests in the order that they appear.

## **CALIBRATION CYCLE**

Perform the tests in this chapter at least once every 24 months.



*Table 2-1. Performance Tests*

<b>Test</b>	<b>Page</b>
1. Internal Timebase: Aging Rate	2-5
2. Swept Frequency Accuracy	2-9
3. Frequency Switching Time	2-13
4. Power Accuracy	2-19
5. Power Flatness	2-23
6. Maximum Levelled Power	2-25
7. External Leveling	2-29
8. Spurious Signals (Harmonics & Subharmonics)	2-31
9. Spurious Signals (Non-Harmonics)	2-35
10. Spurious Signals (Line Related)	2-39
11. Single Sideband Phase Noise	2-43
12. Pulse Modulation On/Off Ratio	2-49
13. Pulse Performance	2-53
14. Pulse Modulation Video Feedthrough	2-59
15. AM Accuracy	2-65
16. AM Bandwidth	2-69
17. AM Dynamic Range	2-73
18. FM Accuracy	2-81
19. FM Bandwidth	2-85
20. Maximum FM Deviation	2-89
21. Internal Pulse Accuracy (Option 002)	2-95
22. Modulation Meter (Option 002)	2-97
Step Attenuator Flatness (see "Automated Tests").	

## 1. INTERNAL TIMEBASE: AGING RATE

### Description and Procedure

This procedure checks the accuracy of the internal time base. The time required for a specific phase change is measured both before and after a specified waiting period. The aging rate is inversely proportional to the absolute value of the difference in the measured times.

The overall accuracy of the internal time base is a function of:

$$TBC \pm AR \pm TE \pm LE$$

TBC = time base calibration

TE = temperature effects

AR = aging rate

LE = line effects

After the time base is adjusted, the timebase frequency should stay within the aging rate if the following things happen:

- The timebase oven does not cool down.
- The instrument keeps the same orientation with respect to the earth's magnetic field.
- The instrument stays at the same altitude.
- The instrument does not receive any mechanical shock.

If the time base oven cools (the instrument is disconnected from ac power), you may have to readjust the time base frequency after a new warmup cycle. Typically, however, the time base frequency returns to within  $\pm 1$  Hz of the original frequency.

### Note



The internal timebase can be tested after reconnecting ac power for 10 minutes, but for best accuracy, test again after the instrument has been on or in standby condition for 24 hours.

Frequency changes due either to a change in orientation with respect to the earth's magnetic field, or to a change in altitude, usually go away when the instrument is returned to its original position. A frequency change due to mechanical shock usually appears as a fixed frequency error.

1. Connect the equipment as shown in figure 2-1. Preset all instruments and let them warm up for at least one hour.

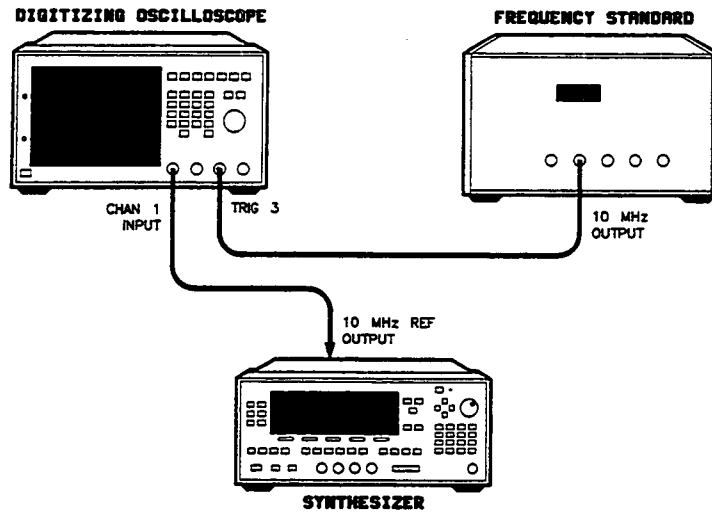

### Note



If the oscilloscope does not have a 50Ω input impedance, connect channel 1 through a 50Ω feedthrough.

*Figure 2-1. Internal Timebase: Aging Rate Test Setup*

2. On the oscilloscope, adjust the external triggering for a display of the 10 MHz REF OUTPUT signal from the synthesizer:

**Channel 1:**

Display	On
Volts/Division	120 mV
Offset	0V
Input Coupling	dc
Input Impedance	50Ω

**Channel 2:**

Display	Off
---------	-----

**Timebase:**

Time/Division	5 ns
Delay	0s
Delay Reference	At center
Sweep	Auto

**Trigger:**

Trigger Mode	Edge
Trigger Source	Trig 3
Input	50Ω

**Display:**

Display Mode	Real time
--------------	-----------

3. Monitor the time and the display. Note the time required for a 360° phase change:  
T1 = \_\_\_\_\_ (s)
4. Wait 3 to 24 hours. Note how long you waited:  
T2 = \_\_\_\_\_ (h)
5. Repeat step 3. Record the phase change time:  
T3 = \_\_\_\_\_ (s)
6. Calculate the aging rate as follows:

$$\text{Aging Rate} = (1 \text{ cycle}/10 \text{ MHz}) (1/T1 - 1/T3) (24 \text{ hours}/T2)$$

Example: T1 = 351 seconds

T2 = 3 hours

T3 = 349 seconds

$$= (1 \text{ cycle}/10 \text{ MHz}) (1/351\text{s} - 1/349\text{s}) (24\text{h}/3\text{h})$$

$$= 1.306 \times 10^{-11} \text{ per day}$$

7. Enter the aging rate on the test record.

**Note**



If the absolute frequency of the standard and of the time base oscillator are extremely close, you can reduce the measurement time (T1 and T3) by measuring the time required for a phase change of less than 360°. In step 6, change 1 cycle to 0.5 cycle for 180°, or 0.25 cycle for 90°.

**Related Adjustments**

10 MHz Standard

### **In Case of Difficulty**

1. Ensure that the instruments have warmed up long enough and that environmental conditions have not changed throughout the test.
2. If the frequency standard and the internal standard are very different in frequency, the time required for a 360° phase shift is too short for an accurate measurement. If the 360° phase shift takes less than two minutes, perform the "10 MHz Standard" adjustment.
3. See "TROUBLESHOOTING" in the *Assembly-Level Repair* manual.

## 2. SWEPT FREQUENCY ACCURACY

### Description and Procedure

With the synthesizer in swept mode, the spectrum analyzer is set to zero span at the measurement frequency. As the synthesizer sweeps through the spectrum analyzer frequency setting, a signal is generated on the spectrum analyzer's video output that is input to the oscilloscope.

The synthesizer's TRIGGER OUTPUT used to trigger the oscilloscope, is a series of 1601 pulses, evenly spaced during the sweep. The oscilloscope is triggered on the pulse that represents the desired measurement frequency, and the spectrum analyzer is tuned to display the video output on the oscilloscope.

1. Connect the equipment as shown in figure 2-2. Preset all instruments and let them warm up for at least one hour.

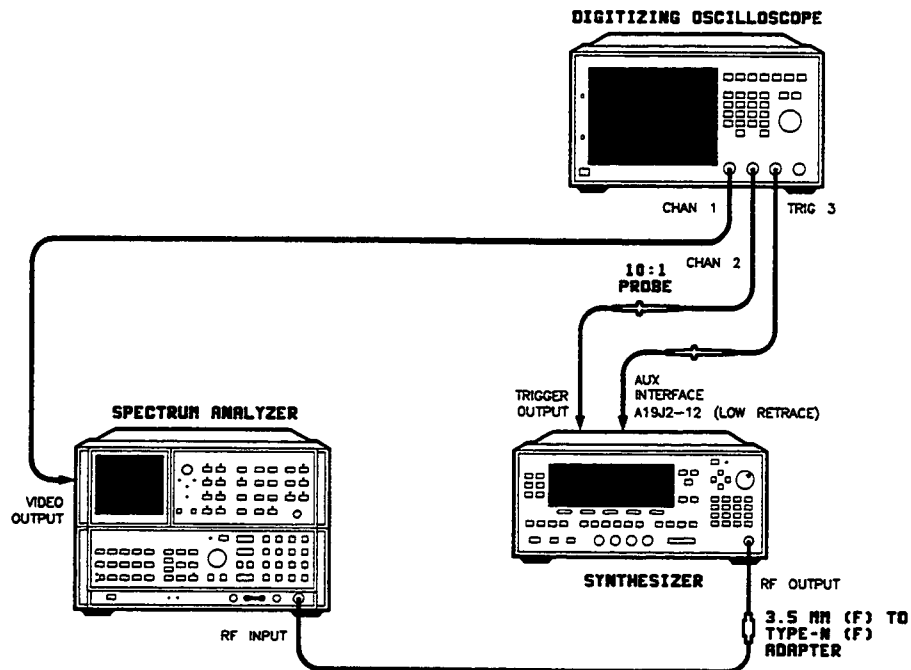

Figure 2-2. Swept Frequency Accuracy Test Setup

2. On the spectrum analyzer, set:

Frequency:	First center frequency in table 2-2
Span:	0 Hz
Reference Level:	0 dBm
Scale Log:	10 dB/div
Resolution Bandwidth:	100 kHz

3. Set the oscilloscope as follows:

### Note



Trigger 3 is a trigger enable that ensures that channel 2 (the true trigger) triggers only on a forward sweep after the specified number of events.

#### Channel 1:

Display	On
Volts/Division	300 mV
Input Coupling	dc
Input Impedance	1 M $\Omega$

#### Channel 2:

Display	On
Volts/Division	1V
Offset	2V
Input Coupling	dc
Input Impedance	1 M $\Omega$

#### Timebase:

Time/Division	50 $\mu$ s
Delay	5.5 $\mu$ s
Delay Reference	At center
Sweep	Triggered

#### Trigger:

Trigger Mode	Edge
Trigger Source	Chan 2
Trigger Level	1.6V
Trigger Source	Trig 3
Trigger Level	1.6V
Trigger Mode	Events
Trigger	After Positive edge
Trigger	On Trig 3
Trigger	First trigger events in table 2-2
Trigger	Of positive edge
Trigger	On channel 2

#### Display:

Display mode	Real time
--------------	-----------

4. On the synthesizer, set:

**USER CAL** [*Freq Cal Menu*] [*Swp Span Cal Always*] (asterisk on)

**START** First start frequency in table 2-2

**STOP** First stop frequency in table 2-2

**Note**



Set the frequency range first, or you cannot set the sweep time properly.

**CONT** **SWEEP TIME** 100 ms

**POWER LEVEL** 0 dBm

*Table 2-2. Swept Frequency Accuracy Instrument Settings*

Synthesizer Frequency (GHz)		Spectrum Analyzer Center Frequency (GHz)	Oscilloscope Trigger Events	Frequency Error	Percent
Start	Stop				
2.3	7	2.399875	34	_____	_____
2.3	7	6.8971875	1565	_____	_____
7	13.5	7.235625	58	_____	_____
7	13.5	13.2603125	1541	_____	_____
15	20	15.2	64	_____	_____
15	20	19.696875	1503	_____	_____
2.3	13.5	2.405	15	_____	_____
2.3	13.5	6.899	657	_____	_____
2.3	13.5	7.193	699	_____	_____
2.3	13.5	13.276	1568	_____	_____
7	20	7.195	24	_____	_____
7	20	13.296875	775	_____	_____
7	20	13.703125	825	_____	_____
7	20	19.796875	1575	_____	_____
2.3	20	2.3995625	9	_____	_____
2.3	20	6.8909375	415	_____	_____
2.3	20	7.189625	442	_____	_____
2.3	20	13.3625	1000	_____	_____
2.3	20	13.915625	1050	_____	_____
2.3	20	19.7898125	1581	_____	_____

5. Tune the spectrum analyzer center frequency to find and center the video signal on the oscilloscope (see figure 2-3). Align the video input with the trigger output at center screen.



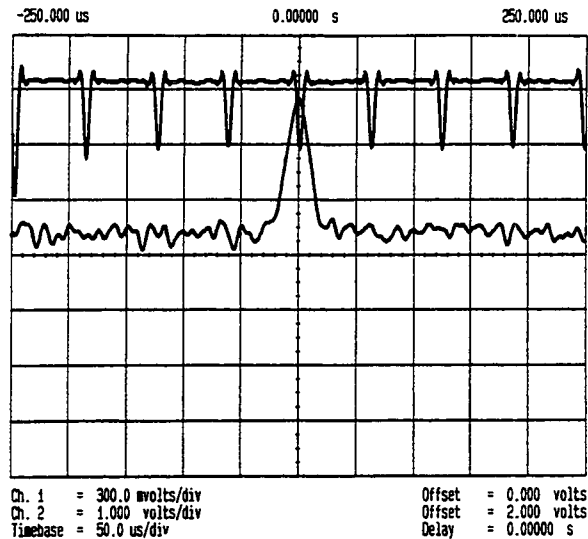

Figure 2-3. Video Signal on the Oscilloscope

6. Note the final center frequency setting required to center the video signal.
7. Record the difference between the initial center frequency setting and the value noted in step 6 in table 2-2 as frequency error.
8. Repeat steps 5 through 7 for the remaining instrument settings in table 2-2.
9. Calculate the frequency error as a percent of the sweep width as follows for each of the results in table 2-2:

$$\frac{\text{frequency error}}{\text{stop frequency} - \text{start frequency}} = \text{percent}$$

10. Record the worst case value on the test record.

### Related Adjustments

YO Driver +10V Reference  
 YO Gain and Linearity  
 YO Delay Compensation  
 Sweep Ramp Calibration

### In Case of Difficulty

1. Verify that the spectrum analyzer frequency is accurate. If necessary, calibrate the frequency with the synthesizer's 10 MHz reference connected to the spectrum analyzer's external reference.
2. See "TROUBLESHOOTING" in the *Assembly-Level Repair* manual.

### 3. FREQUENCY SWITCHING TIME

#### Description and Procedure

The synthesizer's Z-AXIS BLANK/MARKER output goes active high when a change in frequency is initiated, and returns low when the synthesizer settles at the new frequency. Using an oscilloscope to monitor this output, you measure frequency switching time in CW, step sweep, and frequency list modes.

1. Connect the equipment as shown in figure 2-4. Preset both instruments and let them warm up for at least one hour.

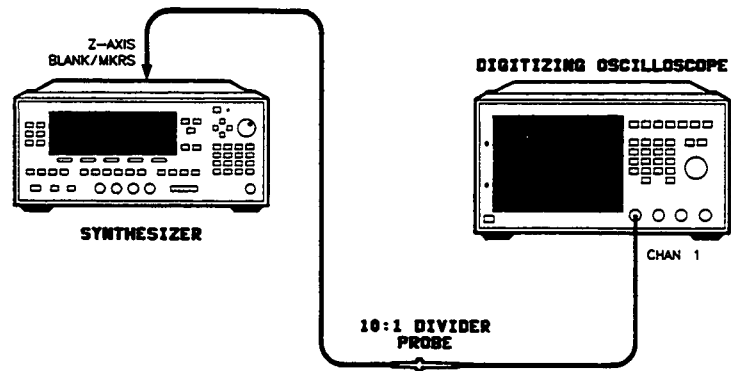

Figure 2-4. Frequency Switching Time Test Setup

### CW Frequency Switching Time

- On the oscilloscope, set:

Channel 1:  
 Display                    On  
 Preset                    TTL  
 Input Coupling            dc

Channel 2:  
 Display                    Off

Timebase:  
 Time/Division            10 ms  
 Delay Reference        At left  
 Delay                    -10 ms  
 Sweep                    Triggered

Trigger:  
 Trigger Mode            Edge  
 Trigger Source        Channel 1  
 Trigger Level            1.6V  
 Trigger Slope            Positive

Display:  
 Display Mode            Repetitive

- On the synthesizer, set the first *Initial CW Frequency* in table 2-3.
- On the oscilloscope, clear the display.  
 The oscilloscope should display *Awaiting Trigger*.
- On the synthesizer, set the first *Second CW Frequency* in table 2-3.

**Table 2-3. CW Frequency Switching Time Settings**

Initial CW Frequency (GHz)	Second CW Frequency (GHz)	Pulse Width
0.01*	20	_____
13.5	20	_____

\* Set to 2 GHz (lowest start frequency) for synthesizers not capable of 0.01 GHz.

- On the oscilloscope, note the pulse width of the Z-axis blank/markers signal. Record this value as pulse width in table 2-3.
- Clear the oscilloscope display and repeat steps 3 through 6 for the remaining frequencies in table 2-3.
- On the test record, record the maximum pulse width from table 2-3.

### Stepped Sweep Frequency Switching Time

9. On the synthesizer, set:

FREQUENCY  [*Step Swp Menu*] [*Step Size*]

[*Step Dwell*]

SWEEP  [*Sweep Mode Step*]

10. On the oscilloscope, set:

Channel 1:

Display	On
Preset	TTL
Input Coupling	dc

Timebase:

Time/Division	2 ms
Delay	-2 ms
Delay Reference	At left
Sweep	Triggered

Trigger:

Trigger mode	Events
Trigger	After negative edge
Trigger Source	Channel 1
Trigger	On 1 events
Trigger	Of positive edge
Trigger	On channel 1

Display:

Display Mode	Repetitive
--------------	------------

11. Set the oscilloscope for a single sweep at the next trigger. Press:

The oscilloscope displays **Awaiting Trigger**

12. On the synthesizer, initiate a stepped sweep. Press:

13. On the oscilloscope:

Measure the positive pulse width and note the value \_\_\_\_\_ .

14. Increment the trigger to 20 events and repeat steps 11 through 13.  
Pulse width value \_\_\_\_\_.
15. Increment the trigger to 45 events and repeat steps 11 through 13.  
Pulse width value \_\_\_\_\_.
16. Record the worst case value from steps 13 through 15 on the test record.

**Frequency List Frequency Switching Time**

17. On the synthesizer, delete any entries in the frequency list menu:

FREQUENCY **(MENU)** [*List Menu*] [*Delete Menu*] [*All*]

18. On the synthesizer, press [*Enter List Freq*] and enter the following frequencies in the frequency list menu:

Frequency (GHz)
2.2
2.4
6.9

19. On the oscilloscope, set:

Channel 1:

Display	On
Preset	TTL
Input Coupling	dc

Channel 2:

Display	Off
---------	-----

Timebase:

Time/Division	5 ms
Delay	-2 ms
Delay Reference	At left
Sweep	Triggered

Trigger:

Trigger Mode	Events
Trigger	After negative edge
Trigger Source	Channel 1
Trigger	On 1 events
Trigger	Of positive edge
Trigger	On channel 1

Display:

Display Mode	Repetitive
--------------	------------

20. On the synthesizer, set:

**SINGLE**

**SWEEP** **MENU** [*Sweep Mode List*]

**SINGLE**

21. On the oscilloscope, set a single sweep at the next trigger. Press:

**Stop/Single**

The oscilloscope displays *Awaiting Trigger*

22. On the synthesizer, initiate a frequency list sweep. Press:

**SINGLE**

23. On the oscilloscope:

Measure the positive pulse width, and note the value:

Pulse Width Value

1 event \_\_\_\_\_

2 events \_\_\_\_\_

3 events \_\_\_\_\_

4 events \_\_\_\_\_

5 events \_\_\_\_\_

6 events \_\_\_\_\_

7 events \_\_\_\_\_

8 events \_\_\_\_\_

9 events \_\_\_\_\_

24. Increment the trigger on events and repeat steps 20 through 24 for a trigger on events up to and including 9.

25. Record the worst case value from step 23 on the test record.

### **Related Adjustments**

Fractional-N VCO  
Sampler Assembly  
YO Loop Gain

### **In Case of Difficulty**

1. Verify that the oscilloscope triggers when stepping between two frequencies. If necessary, adjust the trigger level on the oscilloscope.
2. See "TROUBLESHOOTING" in the *Assembly-Level Repair* manual.

## 4. POWER ACCURACY

### Description and Procedure

Using a power meter, check the power accuracy of the synthesizer at several CW frequencies. At each frequency, verify that the actual output power is within specification over the full dynamic range of the ALC loop.

1. Turn on the equipment shown in figure 2-5 and let them warm up for at least one hour.
2. On the power meter:  
Zero and calibrate the power meter/sensor.  
Set to dBm mode.
3. Connect the equipment as shown in figure 2-5 and press **PRESET** .
4. To achieve peak power, turn on RF peaking. Press:  
**USER CAL** **[Tracking Menu]** **[Peak RF Always]** (asterisk on)

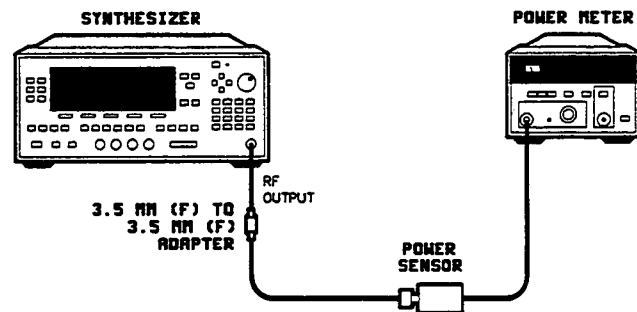

Figure 2-5. Power Accuracy Test Setup

5. On the synthesizer, set:  
**CW** The first CW value in table 2-4  
**POWER** **MENU** **[Up/Dn Power]** **1** **dB**  
**[Uncoupl Atten]** (option 001 only)  
**POWER LEVEL** **-10** **dBm**  
**RF ON/OFF** Off (amber light off)

6. Zero the power meter.
7. On the synthesizer, turn the RF on (amber light on).

*Table 2-4. Power Accuracy Frequencies*

Frequency (GHz)	Measured Difference
0.1*	_____
1.0*	_____
6.0	_____
10.0	_____
18.0	_____
* Not applicable for all models	

8. On the power meter, set the power sensor calibration factor for the frequency to be measured.

**Note**



At low power levels (below 0 dBm), the power meter must settle before the measurement is accurate.

9. Note the difference between the power meter reading and the power value set on the synthesizer.

**Note**



For power levels of 0 dBm and above, measure the power at 0 dBm, then set the attenuator to the 10 dB position (use a 10 dB attenuator for synthesizers without a step attenuator.) Record the difference between the measurements: \_\_\_\_\_ (approximately 10 dB). Then, with the attenuator still set to 10 dB, complete the remaining measurements. Each of these measurements should be offset by the difference in dB that you measured.

10. On the synthesizer, use the up  key to increment the power level 1 dB.
11. Repeat steps 8 through 10, to the maximum specified power level. Record the worst case measured difference for this frequency in table 2-4.
12. On the synthesizer, set the power level to -10 dBm.
13. Repeat steps 7 through 11 for the remaining frequencies in table 2-4.
14. Record the worst case measured values below 2.3 GHz and above 2.3 GHz on the test record.



## **Related Adjustments**

Modulator Offset and Gain  
Power Meter Leveling Accuracy

## **In Case of Difficulty**

See "TROUBLESHOOTING" in the *Assembly-Level Repair* manual.

## 5. POWER FLATNESS

### Description and Procedure

This procedure uses the user flatness correction array to automatically measure power flatness. The power meter is connected directly to the synthesizer's RF output. The synthesizer controls the power meter via HP-IB while the power meter measures the RF output. (There cannot be another controller on the HP-IB during this test.) If the synthesizer has a step attenuator, it is set to 0 dB so that any input into the flatness array indicates the RF output power flatness.

### Note



This performance test requires an HP 437B power meter. The correct power sensor calibration factors must be loaded and selected.

### Caution



This procedure deletes any existing user flatness correction array.

1. Turn on the equipment shown in figure 2-6. Connect the power sensor for the frequency range being calibrated. Do not connect the power sensor to the synthesizer yet. Preset all instruments and let them warm up for at least one hour.

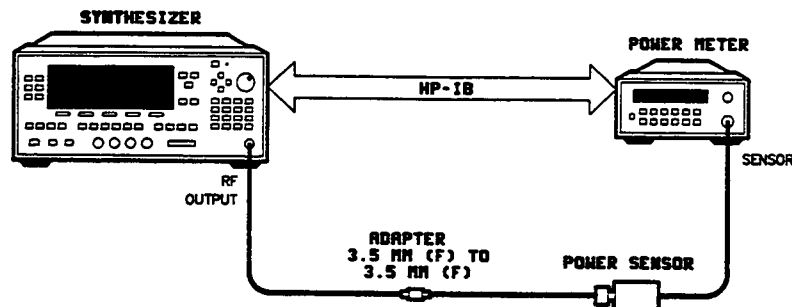

Figure 2-6. Power Flatness Test Setup

### Low Band Power Flatness (not applicable for all models)

2. In the synthesizer's flatness menu:
  - a. Delete all entries in the user flatness correction array:  
POWER **[MENU]** **[Fitness Menu]** **[Delete Menu]** **[Delete All]**
  - b. Set the auto fill start frequency to 15 MHz:  
**[Auto Fill Start]** **[15]** **[MHZ]**

- c. Set the auto fill stop frequency to 2.3 GHz:

**[Auto Fill Stop]** **2.3** **GHz**

- d. Set the auto fill increment to 10 MHz:

**[Auto Fill Incr]** **10** **MHz**

3. On the power meter, load the calibration factors for the power sensor.

Zero and calibrate the power meter/sensor.

Connect the power sensor to the synthesizer's RF OUTPUT as shown in figure 2-6.

4. Set the synthesizer to measure the power correction values and generate a new user flatness array for the frequency range entered. Select:

**[Mtr Meas Menu]** **[Meas Corr All]**

When the flatness correction array is completed, the following message is displayed on the synthesizer: **Cal Completed**

5. Scroll through the user flatness correction values using the up/down arrow keys. Note the maximum and minimum correction values. The difference between them is the power flatness measurement. Record the value on the test record and compare the value to the specification.

#### **High Band Power Flatness**

6. With the appropriate power sensor for this frequency range, repeat steps 2 through 5 for:
  - A 2.35 GHz start frequency.
  - A 20 GHz stop frequency.
  - A 100 MHz increment.

### **Related Adjustments**

Power Flatness

#### **In Case of Difficulty**

1. The power meter must be an HP 437B.
2. The correct calibration factors for the power sensor must be loaded.
3. See "TROUBLESHOOTING" in the *Assembly-Level Repair* manual.

## 6. MAXIMUM LEVELED POWER

### Note



This performance test is not valid unless the synthesizer meets both its power accuracy and power flatness specifications. Perform those tests first.

### Description and Procedure

The unlevelled status indicator is displayed when the instrument is unlevelled as the synthesizer sweeps over specific frequency ranges in fast continuous sweep, and fast and slow single sweep operation. Because of the synthesizer's power accuracy and flatness performance, a power meter is not required for this measurement. The following procedure tests the most likely worst case situations for maximum leveled power.

1. Turn on the equipment shown in figure 2-7. Preset the synthesizer and let it warm up for at least one hour.

### Note



The 20 dB attenuator provides a good match on the RF output. If the synthesizer has a step attenuator, you can simulate a good match by decoupling the step attenuator from the ALC and setting the attenuator to 20 dB.

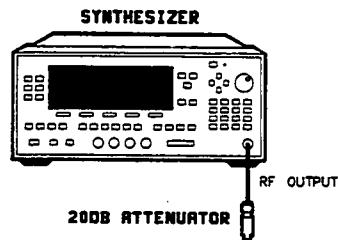

Figure 2-7. Maximum Leveled Power Test Setup

- To achieve peak power, initiate auto tracking on the synthesizer as follows. Terminate the RF OUTPUT with a good 50 ohm impedance match such as a 10 dB attenuator or a power sensor (not necessary for synthesizers with a step attenuator.) Press:

POWER **(MENU)** *[Tracking Menu]* *[Auto Track]*

Wait for the synthesizer to complete auto tracking before continuing to the next step.

- Connect the equipment as shown in figure 2-7.
- On the synthesizer, set:
  - (POWER LEVEL)** Set the power to 1 dB below the specified maximum leveled power.
  - (RF ON/OFF)** (amber light is on)
  - (CONT)** **(SWEEP TIME)** **(0)** **(ms)** (minimum)
  - (START)** First start frequency in table 2-5
  - (STOP)** First stop frequency in table 2-5

Table 2-5. Maximum Leveled Power Test Frequencies

Frequency (GHz)		Power Level
Start	Stop	
Low end of frequency range	High end of frequency range	_____
2.2	"	_____
6.8	"	_____
13.2	"	_____
Low end of frequency range	7.2	_____

- Increase the power level until the unleveled status indicator comes on, then reduce the power level until the indicator just goes off. (Power is leveled).
- Set the sweep to **(SINGLE)** and initiate several sweeps. If necessary, reduce the power level until the unleveled status indicator does not turn on while sweeping.
- On the synthesizer, set:
  - (SWEEP TIME)** **(0.5)** **(sec)**

Initiate several sweeps. If necessary, reduce the power level until the unleveled status indicator does not turn on while sweeping.

Note the power level in table 2-5.

8. On the synthesizer, press:

**CONT** **SWEEP TIME** **0** **msec** (minimum)

9. Repeat steps 5 through 7 for the remaining frequency ranges in table 2-5.

10. Record the worst case value from table 2-5 on the test record.

### **Related Adjustments**

SYTM Adjustments  
Modulator Offset and Gain

### **In Case of Difficulty**

See "TROUBLESHOOTING" in the *Assembly-Level Repair* manual.

## 7. EXTERNAL LEVELING

### Description and Procedure

The synthesizer is set up to externally level using a negative crystal detector. A DVM measures the crystal detector dc output. A 1000 pf capacitor across the DVM input limits the effect of any small signals generated by the DVM. The synthesizer power level is set to the minimum allowable limit and then is increased until the power output is leveled. The external leveling voltage is then measured and compared to the minimum specification. Next, the output power is increased until the maximum leveled power is reached. The leveling voltage is measured and compared to the specification.

### Note



The synthesizer must meet the power flatness specification before proceeding with this test.

1. Preset all instruments shown in figure 2-8 and let them warm up for at least one hour.

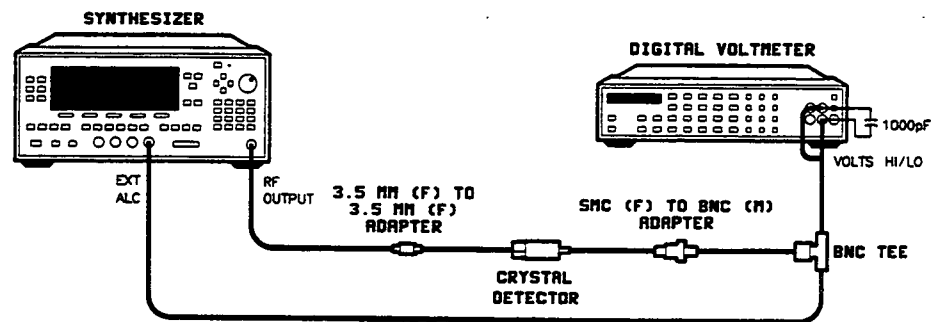

Figure 2-8. External Leveling Test Setup

2. To achieve peak power, initiate auto tracking on the synthesizer as follows: terminate the RF OUTPUT with a good 50Ω impedance match such as an attenuator or a power sensor (not necessary for synthesizers with a step attenuator). Press:

**USER CAL** **[Tracking Menu]** **[Auto Track]** (asterisk on)

Wait for the synthesizer to complete auto tracking before continuing to the next step.

3. Connect the equipment as shown in figure 2-8.

4. On the synthesizer, set:

**ALC** **[Leveling Point ExtDet]** **[Coupling Factor]** **0** **dB**

**POWER LEVEL** **-** **36** **dBm**

5. Set the DVM to measure dc volts.
6. Increase the synthesizer power level until the LOW UNLVLED message turns off. (If it is already out, leave the power level at  $-36$  dBm.)
7. On the synthesizer, set:  
**CW** **10** **GHz**  
Record the DVM reading on the test record and compare the reading to the specification.
8. On the synthesizer, set:  
**START** (to initiate a full sweep)  
**POWER LEVEL** Increase the synthesizer power level until the UNLVLED message turns on. Decrease power just until the message goes out.
9. On the synthesizer, set:  
**CW** **10** **GHz**  
Record the DVM reading on the test record and compare the reading to the specification.

## Related Adjustments

SYTM Adjustments  
Power Flatness

## In Case of Difficulty

1. Be sure you are externally leveling with a negative crystal detector.
2. If the DVM readings are not within the specifications, perform an external detector calibration (under the **USER CAL** key.)
3. See "TROUBLESHOOTING" in the *Assembly-Level Repair* manual.



## 8. SPURIOUS SIGNALS (HARMONIC)

### Description and Procedure

Use this procedure to measure the synthesizer's harmonics and subharmonics over its entire frequency range. Harmonics are integer multiples of the synthesizer RF output frequency and subharmonics are fractional multiples of the YO frequency. Subharmonics do not exist at all frequencies. In low band, mixer spurs and fundamental feedthrough are the most significant harmonically-related signals. The mixer spur/YO frequency relationship is as follows:

$$X (5.4 \text{ GHz fixed oscillator}) - Y (\text{YO frequency}) = \text{Mixer Spur Frequency}$$

where X and Y are integers.

Other harmonics are typically direct multiples of the YO frequency.

In this procedure, the synthesizer is manually swept over its frequency range while the spectrum analyzer measures the harmonics and subharmonics in each frequency band. Any harmonics or subharmonics that are within 5 dB of the specification are subsequently verified with a more accurate procedure.

1. Preset the instruments shown in figure 2-9 and let them warm up for at least one hour.

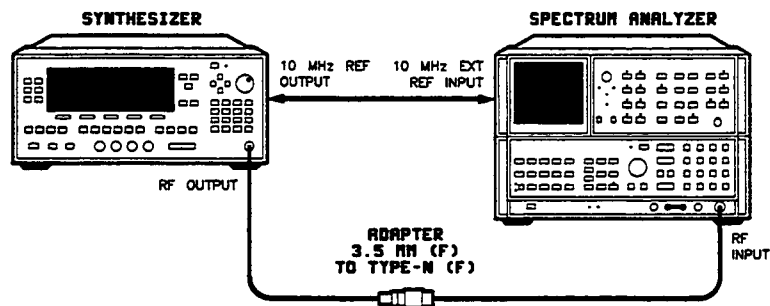

Figure 2-9. Spurious Signals (Harmonic) Test Setup

2. To achieve peak power, turn on RF peaking. Set:  
**USER CAL** [Tracking Menu] [Peak RF Always] (asterisk on).
3. Connect the equipment as shown in figure 2-9.

4. On the synthesizer, set:

**POWER LEVEL** Set the maximum specified leveled power.

**SWEEP MENU** *[Manual Sweep]*

5. On the spectrum analyzer, set:

Frequency: First set of start and stop frequencies from table 2-6 or table 2-7.

Reference Level: -20 dBm

Scale Log: 5 dB/Division

Bandwidth Resolution: 3 MHz

Video Bandwidth 3 MHz

*Table 2-6. 10 MHz to 20 GHz Synthesizers: Spectrum Analyzer Start and Stop Frequencies*

Start Frequency (GHz)	Stop Frequency (GHz)
0.01	2.4
2.4	7.0
7.0	13.5
13.5	20.0

*Table 2-7. 2 GHz to 20 GHz Synthesizers: Spectrum Analyzer Start and Stop Frequencies*

Start Frequency (GHz)	Stop Frequency (GHz)
2.0	7.0
7.0	13.5
13.5	20.0

6. Manually sweep the synthesizer across its entire frequency range while checking the spectrum analyzer display for harmonics and subharmonics.

See table 2-8 or 2-9 for the YO frequency ranges that correspond to the RF output frequencies.

**Table 2-8. 10 MHz to 20 GHz Synthesizers:  
Corresponding YO Frequency Ranges and RF Output Frequencies**

YO Frequencies (GHz)	Harmonic	RF Output Frequencies (GHz)
5.41 to 7.7	N/A	0.01 to 2.3
2.3 to 7.0	1	2.3 to 7.0
3.5 to 6.75	2	7.0 to 13.5
4.5 to 6.67	3	13.5 to 20.0

**Table 2-9. 2 GHz to 20 GHz Synthesizers:  
Corresponding YO Frequency Ranges and RF Output Frequencies**

YO Frequencies (GHz)	Harmonic	RF Output Frequencies (GHz)
2.0 to 7.0	1	2.0 to 7.0
3.5 to 6.75	2	7.0 to 13.5
4.5 to 6.67	3	13.5 to 20.0

7. Compare the amplitude of the harmonics/subharmonics to the specifications listed in the test record. Record the value of the worst case harmonic/subharmonic below 1.8 GHz and above 1.8 GHz. However, if any harmonic/subharmonic is within 5 dB of specification, make a more accurate measurement using the "Harmonic/Subharmonic Verification Procedure" that follows.
8. Repeat steps 5 through 7 for each set of start and stop frequencies in table 2-6 or table 2-7.

### **Harmonic/Subharmonic Verification Procedure**

1. Set the synthesizer to the RF output frequency that corresponds to the harmonic or subharmonic to be measured.
2. On the spectrum analyzer, set:
 

Frequency:	Same frequency as the synthesizer
Span:	1 MHz
Reference Level:	+15 dBm
Scale Log:	5 dB/Division
Bandwidth Resolution:	10 kHz
Video Bandwidth:	30 kHz

3. Measure the synthesizer RF output amplitude with the spectrum analyzer marker.
4. Set the spectrum analyzer to the harmonic or subharmonic frequency to be measured. Measure the signal level with the spectrum analyzer marker. Change the reference level as necessary.
5. Calculate the harmonic/subharmonic level, where the harmonic/subharmonic is less than the carrier, as follows:

$$\text{Harmonic/Subharmonic amplitude (dBc)} = -[\text{Synthesizer RF output amplitude (dBm)} - (\text{Harmonic/Subharmonic amplitude (dBm)})]$$

For example:

$$\begin{aligned} \text{RF Output} &= +10 \text{ dBm} \\ \text{Harmonic} &= -60 \text{ dBm} \\ \text{Harmonic (dBc)} &= [\text{RF Out} - (\text{Harmonic})] \\ &= -[10 - (-60 \text{ dBm})] \\ &= -[10 + 60 \text{ dBm}] \\ &= -70 \text{ dBc} \end{aligned}$$

### **Related Adjustments**

None

### **In Case of Difficulty**

See "TROUBLESHOOTING" in the *Assembly-Level Repair manual*.

## 9. SPURIOUS SIGNALS (NON-HARMONIC)

### Description and Procedure

Use this procedure to measure known, fixed, offset spurs that are generated in the frequency synthesis section of the synthesizer. The synthesizer is set to various CW frequencies where these spurious signals will most likely occur. Then the spectrum analyzer is tuned to the spur frequencies to measure their levels.

1. Preset the instruments shown in figure 2-10 and let them warm up for at least one hour.

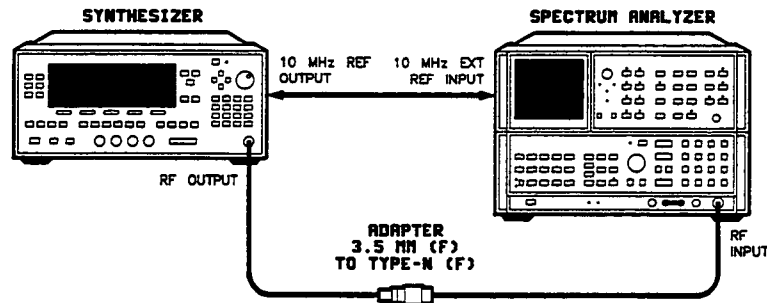

Figure 2-10. Spurious Signals (Non-Harmonic) Test Setup

2. To achieve peak power, turn on RF peaking. Set:  
**USER CAL** **[Tracking Menu]** **[Peak RF Always]** (asterisk on)
3. Connect the equipment as shown in figure 2-10.

#### Fixed Spurious Signals

4. On the synthesizer, set:  
**CW** **19.765** **GHz**  
**POWER LEVEL** Set the maximum specified leveled power.

5. On the spectrum analyzer, set:

Center Frequency: 19.765 GHz  
Frequency Span: 100 Hz  
Reference Level: 10 dBm  
Scale Log: 5 dB/Division  
Resolution Bandwidth: 10 Hz  
Sweep Time: Auto  
Marker: Set to 19.765 GHz

6. On the spectrum analyzer, set the marker to the highest peak and note the frequency difference of the marker from the center frequency. Calibrate the spectrum analyzer frequency offset so that the signal peak is in the center of the display.
7. Note the signal amplitude on the spectrum analyzer. This is the carrier amplitude to which the spurs are referenced.

\_\_\_\_\_ dBm Carrier Amplitude

8. On the spectrum analyzer, set:

Center Frequency: Spectrum analyzer frequency for the first spur from table 2-10  
Reference Level: -50 dBm  
Video Averaging: On 100 samples  
Marker: Same as spectrum analyzer frequency

9. Locate the spur corresponding to the spectrum analyzer frequency (see table 2-10) and use the marker to measure its amplitude. If the spur is in the noise level, use the noise level amplitude (this gives a worst case value).

\_\_\_\_\_ dBm Spur Absolute Amplitude

10. Calculate the spur level in dBc as follows:

Carrier Amplitude (dBm) - Spur Absolute Amplitude (dBm) = Spur Level (dBc)

Record the result on the test record. Compare the result to the specification.

11. Repeat steps 8 through 10 for each of the spurs and spectrum analyzer frequencies in table 2-10.

Table 2-10. Spectrum Analyzer Frequencies and Corresponding Spur Frequencies

Spur Frequency* (kHz)	Spectrum Analyzer Frequency (Hz)
20 + Calibration Constant #18	19,765,020,000
40 + 2(Calibration Constant #18)	19,765,040,000
60 + Calibration Constant #19	19,765,060,000
120 + 2(Calibration Constant #19)	19,765,120,000
125	19,765,125,000
500	19,765,500,000

\* To determine the actual frequency of the spur, add the value of the calibration constant (or twice the value, where indicated) to the frequency. For example, set:

**SERVICE** [Adjust Menu] [Calib Menu] [Select Cal]

Use the RPG knob to select calibration constant #19. If the value for this calibration constant is -800, the spur frequency calculation for the 60 kHz spur is:

$$60 \text{ kHz} + (-800) = 59.2 \text{ kHz.}$$

### Low Band Spurious Signals

12. On the synthesizer, set:

**CW** **1** **GHz**

13. On the spectrum analyzer, set:

Center Frequency: 1 GHz  
 Frequency Span: 500 Hz  
 Reference Level: 15 dBm  
 Resolution Bandwidth: Auto  
 Video Bandwidth: Auto  
 Marker: 1 GHz

14. Use the marker to measure the synthesizer's RF output amplitude at 1 GHz. This is the carrier amplitude to which the spurs are referenced.

\_\_\_\_\_ dBm RF output at 1 GHz

15. Set the spectrum analyzer center frequency to each of the frequencies in table 2-11. Use the marker to measure the spurs (change the reference level as necessary).

Calculate the spur level in dBc for each of the spurs as follows:

$$\text{Spur Level (dBc)} = -[\text{RF Output at 1 GHz (dBm)} - (\text{Spur Level})]$$

Record the spur level in dBc on the test record. Compare the spur level to the specification.

Table 2-11. Low Band Spurious Signals

Spectrum Analyzer Frequency	Spur
100 MHz 900 MHz 6.4 GHz	100 MHz Fixed Spur 100 MHz Offset Spur LO Feedthrough Spur

### Related Adjustments

Fractional-N Reference and API Spurs

### In Case of Difficulty

See "TROUBLESHOOTING" in the *Assembly-Level Repair* manual.



## 10. SPURIOUS SIGNALS (LINE-RELATED)

### Description and Procedure

Use this procedure to measure line-related spurs. The synthesizer is placed at a CW frequency where the synthesizer is most sensitive to line-related spurs. The spectrum analyzer measures the RF output offset by the harmonics of the line power frequency (60 Hz or 50 Hz). To eliminate measuring the spectrum analyzer line related spurs, an Invertron is used to operate the spectrum analyzer at a different line frequency so that its own spurs will not affect the measurement.

### Note



The spectrum analyzer must have a 10 Hz resolution bandwidth. A wider resolution bandwidth results in the synthesizer's phase noise masking the spur.

1. Set the invertron for a line frequency of 55 Hz and for normal operating voltage.
2. Connect the equipment as shown in figure 2-11. Preset the instruments and let them warm up for at least one hour.

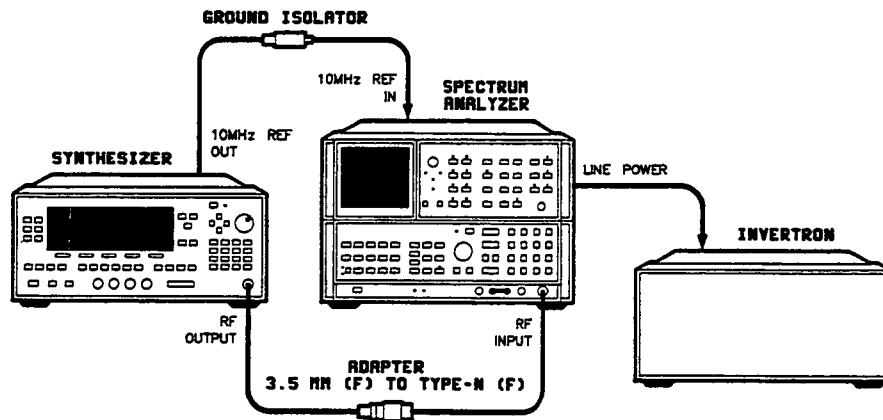

Figure 2-11. Spurious signals (Line-Related) Test Setup

3. To achieve peak power, turn on RF peaking. Set:  
**USER CAL** [Tracking Menu] [Peak RF Always] (asterisk on)

4. On the synthesizer, set:

**CW** **6.99** **GHz**

**POWER LEVEL** **0** **dBm**

5. On the spectrum analyzer, set:

Center Frequency: 6.99 GHz  
Frequency Span: 2 kHz  
Reference Level: 10 dBm  
Scale Log: 5 dB/Division  
Resolution Bandwidth: 300 Hz  
Sweep Time: Auto  
Marker: Set to 6.99 GHz

6. On the spectrum analyzer, set the marker to the highest peak and note the frequency difference of the marker from the center frequency. Calibrate the spectrum analyzer frequency offset so that the signal peak is in the center of the display.
7. Note the signal amplitude on the spectrum analyzer. This is the carrier amplitude to which the spurs are referenced.

\_\_\_\_\_ dBm Carrier Amplitude

### Note



This procedure is written for a line frequency of 60 Hz. For a 50 Hz line frequency, look for spurs at frequencies of 50 Hz times the harmonics in table 2-12, and set the spectrum analyzer frequencies accordingly.

8. On the spectrum analyzer, set:

Center Frequency: Spectrum analyzer frequency for the first spur from table 2-12  
Reference Level: -50 dBm  
Frequency Span: 100 Hz  
Resolution Bandwidth: 10 Hz  
Marker: Same as spectrum analyzer frequency  
Video Averaging: On 100 samples

9. Locate the spur corresponding to the spectrum analyzer frequency (see table 2-12) and use the marker to measure its amplitude. If the spur is in the noise level, use the noise level amplitude (this gives a worst case value).

\_\_\_\_\_ dBm Spur Absolute Amplitude

10. Calculate the spur level in dBc as follows:

$$\text{Spur Level (dBc)} = -[\text{Carrier Amplitude (dBm)} - (\text{Spur Level})]$$

Record the result on the test record. Compare the result to the specification.

### Note



The odd harmonics will normally be higher than the even harmonics.

11. Repeat steps 8 through 10 for each of the spurs and spectrum analyzer frequencies in table 2-12. Change the spectrum analyzer reference level as indicated in the table.

Table 2-12. *Spectrum Analyzer Frequencies and Line Spur Frequencies and Harmonics*

Line Spur Harmonic	Line Spur Frequency (Hz)	Spectrum Analyzer Frequency (Hz)	Reference Level (dBm)
2	120	6,990,000,120	-50
3	180	6,990,000,180	-50
4	240	6,990,000,240	-50

12. For synthesizers capable of frequencies down to 10 MHz, set the synthesizer and spectrum analyzer to 2.3 GHz and repeat steps 6 through 11 for this frequency.

### Related Adjustments

None

### In Case of Difficulty

See "TROUBLESHOOTING" in the *Assembly-Level Repair* manual.

## **11. SINGLE SIDEBAND PHASE NOISE**

### **Description and Procedure**

This test provides two procedures. The first procedure uses a Phase Noise Measurement System and is the faster, more accurate method. The alternate procedure uses a high performance spectrum analyzer. This method degrades the measurement accuracy due to the addition of the spectrum analyzer's phase noise. Use the alternate procedure *only* if a Phase Noise Measurement System is not available.

1. Connect the equipment as shown in figure 2-12. Preset the equipment and let them warm up for at least one hour.

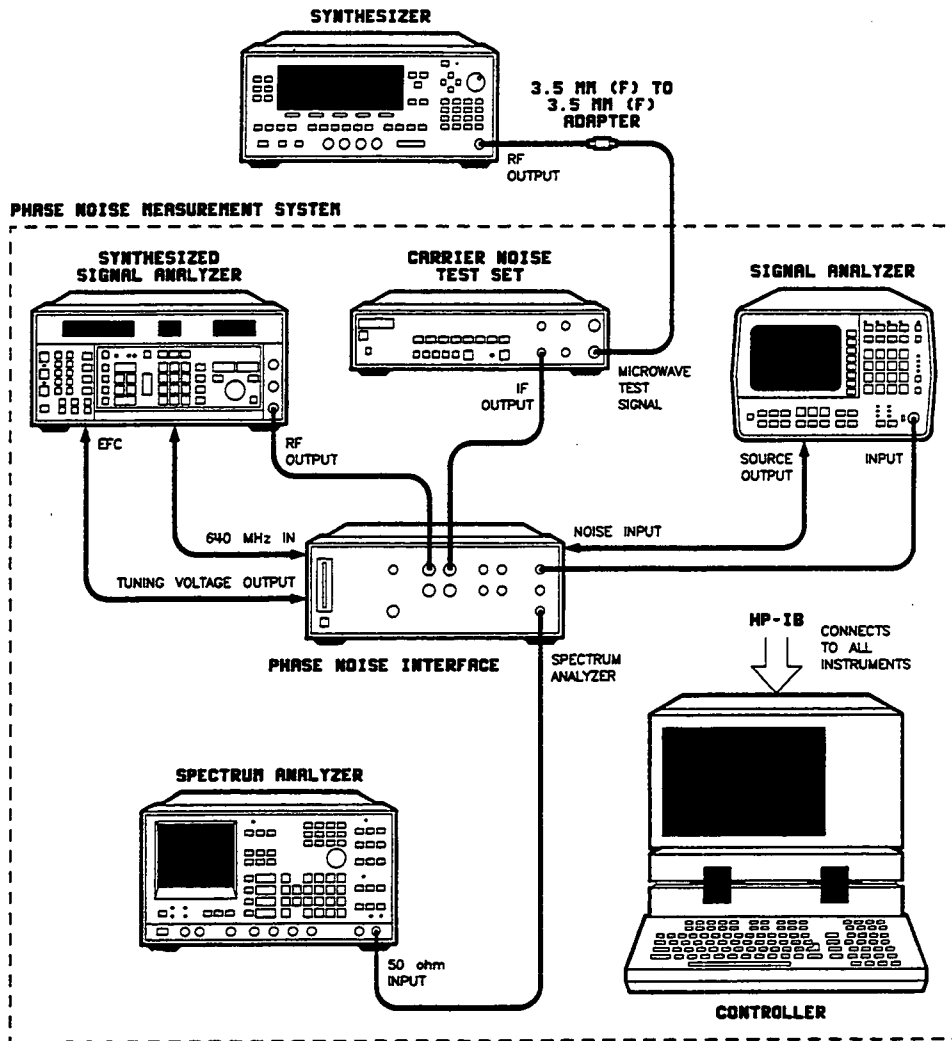

Figure 2-12. Single Sideband Phase Noise Test Setup

2. Load the measurement software for the Phase Noise Measurement System.

3. On the synthesizer, set:

**CW** **6.99** **GHz**

**POWER LEVEL** **0** **dBm**

4. On the Phase Noise Measurement System, set:

Measurement Type: phase locked  
Start Offset Freq: 100 Hz  
Stop Freq: 2 MHz  
Minimum Averages: 40  
Carrier Frequency: 6.99 GHz  
Det Input Freq: 50 MHz  
DUT: user's srce, man  
Ref Source: 8662A, SYS, VCO, EFC  
Ext Timebase: not in use  
Down Converter: 1179C, SYS  
HP 11848A LNA: out

### Note



To avoid entering these parameters each time you perform this test, create a file on the Phase Noise Measurement System containing these parameters.

With these parameters entered, the software automatically sets the remaining parameters. Table 2-13 shows the complete set of parameters.

*Table 2-13. Phase Noise Measurement System Parameters*

Measurement Type:	phase locked	K_VCO Method:	Measured
Start Offset Freq:	100 Hz	VCO Tune Constant:	82.33 Hz/V
Stop Freq:	2 MHz		
Minimum Averages:	40	Loop Suppression:	Verified
		Closed PLL BW:	150.5 Hz
Carrier Frequency:	6.99 GHz	Peak Tuning Range:	725.1 Hz
Det Input Freq:	50 MHz	Assumed Pole:	37.9 kHz
Entered K_VCO:	28 Hz/V	DUT:	user's srce, man
Center Voltage:	0V	Ref Source:	8662A, SYS, VCO, EFC
Tune-voltage Range:	±10V	Ext Timebase:	not in use
Phase Detector:	5 to 1600 Mhz	Down Converter:	11792C, SYS
K_Detector Method:	measured	HP 11848A LNA:	Out
Detector Constant:	458.8 mV/Rad		

5. Follow the instructions on the controller to make the phase noise measurement.
6. At the message:

VERIFY BEATNOTE <1 MHZ

The dynamic signal analyzer has two traces. The sine wave shows the beatnote frequency in time domain (like an oscilloscope). The other trace is in the frequency domain (like a spectrum analyzer). Tune the signal generator for minimum sine wave frequency with the frequency domain signal near the left edge (0 Hz).

7. When the measurement is complete record the results on the test record and compare them to the specification.
8. Repeat steps 3 through 6 for the frequencies in table 2-14.

*Table 2-14. Frequency Setting for Phase Noise Measurements*

Synthesizer Frequency (GHz)	Phase Noise Measurement System	
	Carrier Frequency (GHz)	Detector Input (MHz)
2.23	2.23	310
18.0	18.0	720

## Related Adjustments

Sampler Assembly

## In Case of Difficulty

1. Line spurs may be present in the trace which exceed the phase noise specification. They should be ignored.
2. Be sure that the signal generator frequency (detector input) is tuned close enough that a zero beat can be found.
3. Note where the problem occurs (carrier frequency and offset frequency from the carrier) and see "TROUBLESHOOTING" in the *Assembly-Level Repair* manual.

## ALTERNATE PROCEDURE – SINGLE SIDEBAND PHASE NOISE

### Description and Procedure

This procedure uses a high performance spectrum analyzer. This method degrades the measurement accuracy approximately 3 dB due to the addition of the spectrum analyzer's phase noise. Use this procedure *only* if a Phase Noise Measurement System is not available.

1. Connect the equipment as shown in figure 2-13. Preset the equipment and let them warm up for at least one hour.

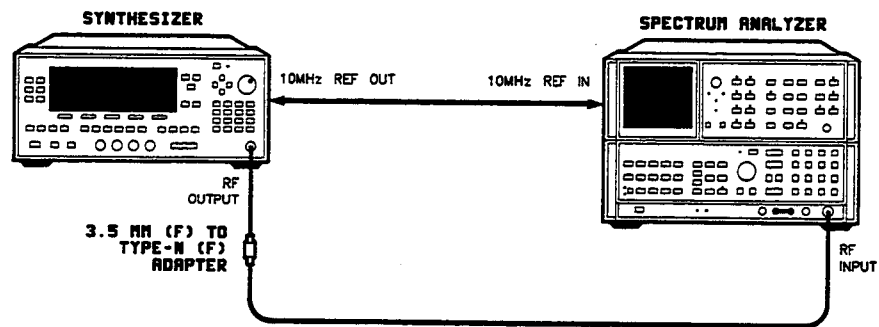

Figure 2-13. Alternate Phase Noise Test Setup

2. On the synthesizer, set:

**CW** **6.99** **GHz**  
**POWER LEVEL** **0** **dBm**

3. On the spectrum analyzer, set:

Center Frequency:	Same frequency set in step 2
Frequency Span:	1 MHz
Reference Level:	0 dBm
Scale Log:	2 dB/Division
Resolution Bandwidth:	Auto
Video Bandwidth:	Auto
Sweep:	Auto
Video Averaging:	Off



4. On the spectrum analyzer:  
Center the CW carrier signal on the display.  
Reduce the frequency span to 100 Hz.
5. On the synthesizer, press **POWER LEVEL** and use the rotary knob to adjust the power level to place the signal peak at the 0 dBm reference level on the analyzer.
6. On the spectrum analyzer, set:
 

CF Step Size:	First CF step size in table 2-15
Reference Level:	-10 dBm
Frequency Span:	0 Hz
Scale Log:	10 dB/Division
Marker:	Noise level measurement
Center Frequency:	Increase (step up) by CF step size
7. After several sweeps, record the worst-case marker noise measurement (dBc/Hz) on the test record for the carrier offset frequency (from table 2-15) and compare it to the specification.
8. On the spectrum analyzer, change the CF step size to each of the settings in table 2-15 (to achieve the associated frequency offset from the carrier), step up the center frequency, and then repeat step 7.

*Table 2-15. CF Step Size and Carrier Offset Frequencies*

CF Step Size	Carrier Offset Frequency
100 Hz	100 Hz
900 Hz	1 kHz
9.1 kHz	10 kHz
90 kHz	100 kHz

9. On the spectrum analyzer, repeat steps 2 through 8 for synthesizer CW frequencies of 2.23 GHz and 18 GHz.

### **Related Adjustments**

Sampler Assembly

### **In Case of Difficulty**

This method of measuring phase noise introduces potential errors due to the addition of the spectrum analyzer's phase noise into the measurement. Use a Phase Noise Measurement System (the procedure preceding this one) and retest the failed frequencies.

## 12. PULSE MODULATION ON/OFF RATIO

### Description and Procedure

Using a spectrum analyzer, the synthesizer's CW RF output power is measured both with pulse on and with pulse off. The difference in power is the pulse on/off ratio.

1. Connect the equipment as shown in figure 2-14. Preset all instruments and let them warm up for at least one hour.

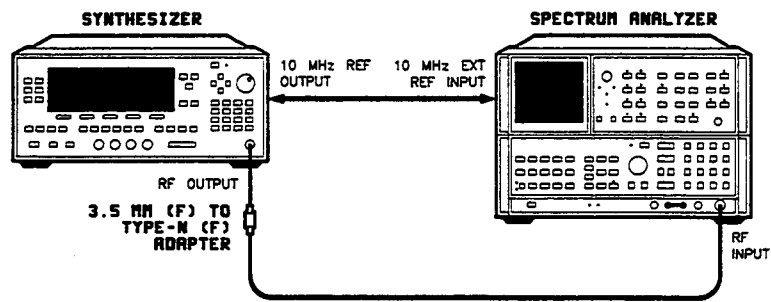

Figure 2-14. Pulse Modulation On/Off Ratio Test Setup

2. On the synthesizer, set:

**CW** The first center frequency in table 2-16

**POWER LEVEL** **-** **9.9** **dBm**

**FREQUENCY** **MENU** **[Up/Dn Size CW]** **50** **MHz**

3. On the spectrum analyzer, set:

Center Frequency: The same frequency set in step 2

Frequency Span: 100 Hz

Reference Level: 0 dBm

Marker: On

Resolution Bandwidth: 10 Hz

Sweep Time: 50 ms

Center Frequency Step Size: 50 MHz

Table 2-16. Pulse On/Off Center Frequencies

Center Frequency (GHz)	Maximum Marker Amplitude
1.0*	_____
6.0	_____
9.0	_____
16.0	_____
* Not applicable for all models	

4. On the spectrum analyzer:
  - Tune center frequency to center the signal on the display.
  - Set the marker to highest peak.
  - Note the marker amplitude.
5. On the synthesizer, turn on the external pulse:
  - MOD** [*Pulse On/Off Extrl*] (asterisk on)
6. On the spectrum analyzer set the reference level to  $-70$  dBm.
7. Set the marker to the highest peak and note the maximum marker amplitude.
8. The difference between the marker value in step 4 and the marker value in step 7 is the pulse on/off ratio. Record this value in table 2-16.
9. On the spectrum analyzer, set the reference level to 0 dBm.
10. On the synthesizer, turn off external pulse:
  - MOD** [*Pulse On/Off Extrl*] (asterisk off)
11. Repeat steps 2 through 10 for the remaining synthesizer and spectrum analyzer frequencies in table 2-16 with the following changes to step 7 when testing 6.0 GHz:
  - For a CW Frequency of 6.0 GHz:
    - a. Step the synthesizer and spectrum analyzer in 50 MHz steps from 6.0 to 7.0 GHz.
    - b. Note the frequency of the highest amplitude signal. Set the synthesizer and spectrum analyzer to this frequency.
    - c. Set the marker to the highest peak and note the maximum marker amplitude.
12. Record the worst case value from table 2-16 on the test record.

## **Related Adjustments**

None

## **In Case of Difficulty**

1. A failure can be caused by a spur. Move the center frequency of both the spectrum analyzer and the synthesizer by 1 kHz, and retest at that point. If the on/off ratio is bad, it will be bad over greater than a 100 kHz region.
2. See "TROUBLESHOOTING" in the *Assembly-Level Repair* manual.

### 13. PULSE PERFORMANCE

#### Description and Procedure

In this procedure, the synthesizer's RF output is downconverted in frequency so that an oscilloscope can measure the rise and fall times and make a comparison of pulsed and CW power level accuracy. Power level accuracy is checked at a 10 Hz pulse repetition rate to verify its operation at the slowest specified rate. The power amplifier ensures a sufficient signal level into the oscilloscope to make the measurement.

#### Rise and Fall Times

1. Connect the equipment as shown in figure 2-15. Preset the instruments and let them warm up for at least one hour.

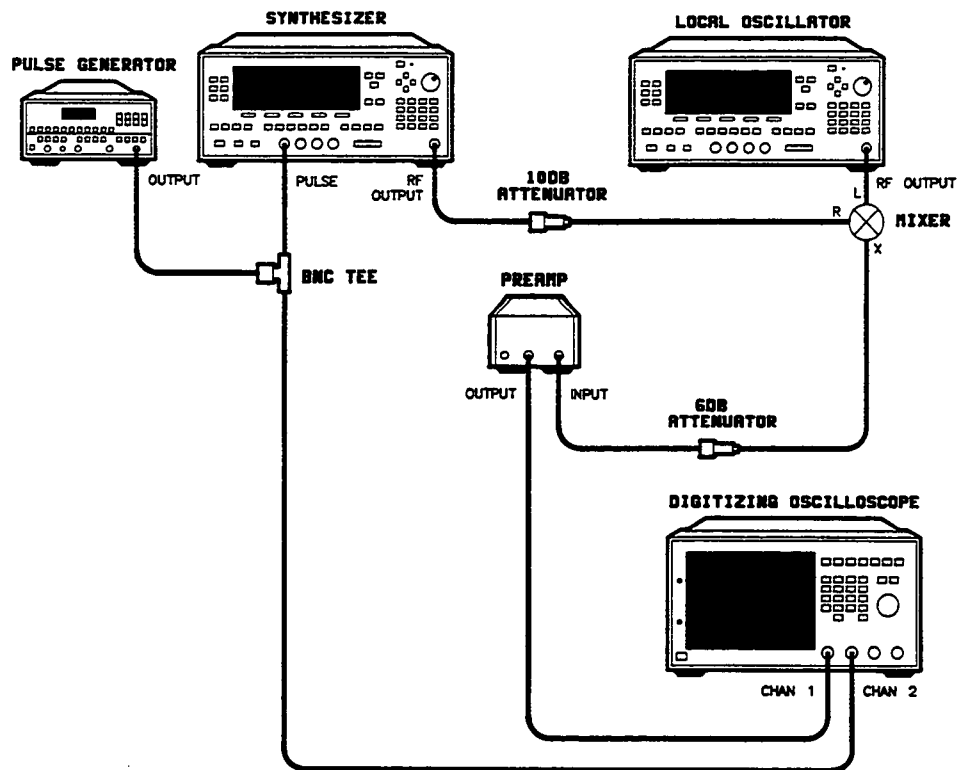

Figure 2-15. Pulse Performance Test Setup

2. On the synthesizer, set:

**CW** First synthesizer frequency in table 2-17

**POWER LEVEL** **-** **5** **dBm**

**ALC** [**Leveling Point Internal**] (asterisk on)

[**Leveling Mode Search**] (asterisk on)

3. On the local oscillator (HP 83620A), set:

Center Frequency: First LO frequency in table 2-17

Power Level: 10 dBm

RF Power: On

Table 2-17. Synthesizer and LO frequencies

Synthesizer Frequencies (GHz)	LO Frequencies (GHz)	Risetime	Falltime	Level Accuracy
1.9*	2.4*	_____	_____	_____
5.0	4.5	_____	_____	_____
9.0	8.5	_____	_____	_____
15.0	14.5	_____	_____	_____

\* Not applicable for all models.

## Note



The CW frequencies checked provide a minimum verification of pulse performance. If pulse performance at a different frequency is important, repeat the test at that CW frequency.

4. On the pulse generator, set:

Pulse Width: 200 ns

Pulse Period: 10 us (100 kHz)

Pulse Level: 5V

Disable: LED off (enables pulse generator)

5. On the oscilloscope, set:

Channel 1:	
Display	On
Volts/Division	100 mV
Offset	0V
Input Coupling	dc
Input Impedance	50 ohms
Channel 2:	
Display	Off
Timebase:	
Time/Division	10 ns
Delay	100 ns
Delay Reference	At center
Trigger:	
Trigger Mode	Edge
Trigger Source	Chan 2
Trigger Level	2V
Display:	
Display Mode	Repetitive
Averaging	On
Number of Averages	1
Screen	Single

**Note**



On the oscilloscope, turn the waveform math function on. Then use the waveform math maximum function to determine the pulse envelope when making the following measurements.

6. On the synthesizer, set:

**MOD** [**Pulse On/Off Extnl**] (asterisk on)

7. On the oscilloscope:

- a. Adjust the timebase delay to position the rising edge of the pulsed RF near the center of the display.
- b. Adjust the channel 1 volts/division and offset to obtain a 5 division signal level between the RF power off and the RF power on (see figure 2-16.)
- c. Adjust the channel 1 offset to move the the RF power off line one-half division below the nearest horizontal graticule (making the horizontal graticule cross the waveform at the 10% point.)
- d. Use the oscilloscope's delta T function to measure the time difference between the 10% and 90% risetime points on the envelope. (The 10% point of the risetime is where the pulse envelope crosses the graticule. The 90% point is 4 divisions up.) Record this value in table 2-17.

14-18-19

*Yean*  
*DRF / soon it is a system*

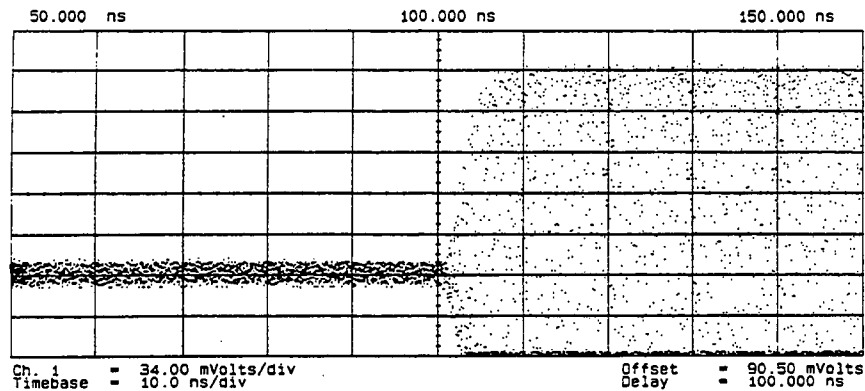

**Figure 2-16. Signal Level between RF Power Off and On**

8. Adjust the timebase delay to position the falling edge of the pulse near the center of the oscilloscope display.
9. Measure the falltime the same way as you measured the risetime (see step 7). Record this value in table 2-17.
10. Repeat steps 6 through 8 at each synthesizer and LO frequency in table 2-17.
11. Record each worst case risetime and falltime value from table 2-17 on the test record.

**Pulse Leveling Accuracy**

12. On the pulse generator, set:
  - Pulse Width:            1 us
  - Pulse Period:           0.1s (10 Hz)
  - Pulse Level:            5V
13. On the synthesizer, set:
  - CW First synthesizer frequency in table 2-17
  - POWER LEVEL  -  5  dBm
  - ALC [**Leveling Mode Normal**]
  - MOD [**Pulse On/Off Extnl**] (asterisk on)



14. On the spectrum analyzer, set:

Center Frequency: First frequency in table 2-17

15. On the oscilloscope, set:

Channel 1:

Volts/Division 30 mV

Timebase: 100 ns

Time/Division

Delay Reference At left

Adjust the delay and timebase so that the pulse waveform takes up the entire display. Adjust the oscilloscope channel 1 offset to position the top of the pulse envelope near the center graticule.

16. On the synthesizer, turn off external pulse and set the power level to  $-5.3$  dBm. Press:

**[Pulse On/Off Extrl]** (asterisk off)

**POWER LEVEL** **-** **5.3** **dBm**

17. Use the oscilloscope's waveform math maximum function to determine the peak power level (if the waveform math function was previously on, clear the display before executing this step.) Use the oscilloscope's delta V feature and position marker 1 at the center of the peak power as displayed by the math waveform (the width of the waveform is caused by noise in the system.) Leave the marker at that position.

18. Set the synthesizer's power level to  $-4.7$  dBm. Press:

**POWER LEVEL** **-** **4.7** **dBm**

19. Clear the oscilloscope display and use the oscilloscope's waveform math maximum feature to determine the peak power level. Use the oscilloscope's delta V feature and position marker 2 at the center of the peak power as displayed by the math waveform.

20. On the synthesizer, set:

**POWER LEVEL** **-** **5** **dBm**

**MOD** **[Pulse On/Off Extrl]** (asterisk on)

21. Reset the oscilloscope waveform math feature to maximum and observe the peak pulse power. It should stay within the two delta V markers set in steps 14 and 17. Record the value in table 2-17 as Level Accuracy.

22. Repeat steps 11 through 20 at each synthesizer and LO frequency in table 2-17.

23. Record the worst case value from table 2-17 on the test record.

## **Related Adjustments**

Pulse Delay

### **In Case of Difficulty**

1. A noisy amplifier can cause a noisy trace that is too wide to measure. Substitute amplifiers to verify a problem with the amplifier.
2. If there is no change in amplification, the amplifier may be saturated (operating in compression). The 0.3 dB variation should be approximately equal on both sides. Try a lower synthesizer power level to get the amplifier out of saturation.
3. See "TROUBLESHOOTING" in the *Assembly-Level Repair* manual.

## 14. PULSE MODULATION VIDEO FEEDTHROUGH

### Description and Procedure

In CW, at specified maximum leveled power, the synthesizer is pulse modulated using a pulse generator. The synthesizer's RF output is filtered (only the video feedthrough passes), amplified, and displayed on an oscilloscope. Because of the low amplitude of the video feedthrough, a preamplifier is used in the test setup; system gain must be considered when making this measurement.

When video feedthrough is expressed as a percentage, the following equation is used:

$$\text{Video feedthrough (\%)} = [(\text{video } V_p / \text{carrier } V_p) \times 100] / \text{video gain}$$

1. Preset all the instruments shown in figure 2-17 and let them warm up for at least one hour.
2. To achieve peak power, turn on RF peaking:

**USER CAL** [*Tracking Menu*] [*Peak RF Always*] (asterisk on)

3. Connect the equipment as shown in figure 2-17 with the pulse generator connected directly to channel 1 of the oscilloscope (A).

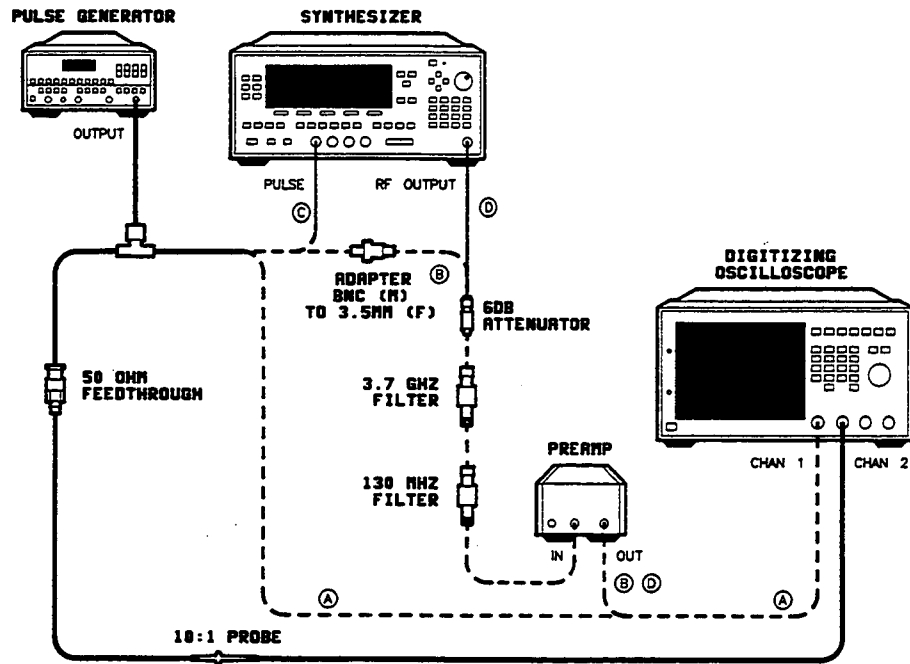

Figure 2-17. Video Feedthrough Test Setup

## System Calibration

### Note



The pulse generator output level can be affected by loading. Leave the pulse generator connected to the oscilloscope's channel 2 (through the BNC tee) as you set the output level.

4. On the oscilloscope, set:

**Channel 1:**

Display	On
Volts/Division	50 mV
Offset	0V
Input Coupling	dc
Input Impedance	50Ω

**Channel 2:**

Display	Off
---------	-----

**Timebase:**

Time/Division	20 ns
Delay	0s
Delay Reference	At center

**Trigger:**

Trigger Mode	Edge
Trigger Source	Channel 1
Trigger Level	0.05V
Trigger Slope	Positive

**Display:**

Display Mode	Repetitive
Averaging	On
Number of Averages	16

5. On the pulse generator, set:

Pulse:	Selected
Pulse width:	10 ns
Frequency:	2 MHz (500 ns)
Offset:	0V

6. On the pulse generator, set the pulse amplitude for a reading of 0.1V on the oscilloscope.

### Video Gain

7. Connect the pulse generator to the oscilloscope's channel 1 through the attenuator, filters, and amplifier (B).

8. On the oscilloscope, set:

Channel 1:

Volts/Division      0.2V  
 Offset                -0.3V  
 Input Coupling      dc  
 Input Impedance    50Ω

Trigger:

Trigger Mode        Edge  
 Trigger Source      Channel 1  
 Trigger Level        -0.4V  
 Trigger Slope        Negative

9. On the oscilloscope, note the pulse amplitude: \_\_\_\_\_ Vp

10. Calculate the video gain:

$$\text{Video gain} = \frac{\text{system Vp (from step 7)}}{\text{pulse generator Vp}}$$

$$= \frac{\text{system Vp}}{0.1 \text{ Vp}}$$

**Low Band Video Feedthrough** (not applicable for all models)

11. Connect the pulse generator output to the synthesizer's pulse input (C).

12. Connect the synthesizer to the oscilloscope's channel 1 through the attenuator, filters, and amplifier (D).

13. On the synthesizer, set:

CW First CW frequency in table 2-18.

ALC [Leveling Mode Search].

POWER LEVEL  8.5  dBm for option 001.

or

10  dBm for standard, option 006 and option 006/001 synthesizers.

MOD [Pulse On/Off Extnl] (asterisk on).

Table 2-18. Low Band Video Feedthrough Frequencies

Synthesizer CW Frequency (GHz)	Video Feedthrough (%)	
	8.5 or 10 dBm	>10 dBm
0.4		
0.7		
1.0		
1.3		
1.6		
1.9		
2.2		

14. On the oscilloscope, set:

Channel 1:

Display	On
Volts/Division	0.010V
Offset	0V
Input Coupling	dc
Input Impedance	50Ω

Channel 2:

Display	Off
Volts/Division	1V
Offset	2V

Timebase:

Time/Division	200 ns
Delay	400 ns
Delay Reference	At center

Trigger:

Trigger Mode	Edge
Trigger Source	Channel 2
Trigger Level	1V
Trigger Slope	Positive

Display:

Display Mode	Repetitive
Averaging	On
Number of averages	64

15. On the pulse generator, set:

Pulse width:	500 ns
Frequency:	200 kHz (5 μs)
Offset:	0V
Amplitude:	5V

16. On the oscilloscope, note the maximum voltage from the baseline (see figure 2-18). Video feedthrough (V<sub>p</sub>) = \_\_\_\_\_ V<sub>p</sub>

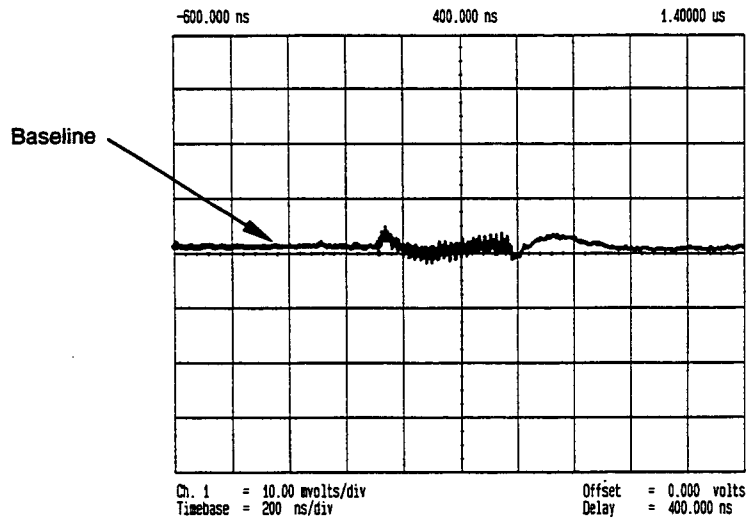

**Figure 2-18. Measuring Maximum Voltage from the Baseline Video Feedthrough**

17. Using the video gain from step 10, the video feedthrough ( $V_p$ ) from step 16, and the carrier voltage from table 2-19, calculate the video feedthrough as a percent of carrier power:

$$\text{Video feedthrough (\%)} = [( \text{video } V_p / \text{carrier } V_p ) \times 100] / \text{video gain}$$

**Table 2-19. Power Level Conversions to Volts Peak**

Synthesizer Maximum Specified Power (dBm) Into 50Ω	Peak Carrier Voltage <sup>1</sup> (V)
8.5	0.841
10.0	1.0
11.5 <sup>2</sup>	1.1885
13.0 <sup>2</sup>	1.41

1. Peak Carrier Voltage =  $10^{\frac{(\text{PdBm} - 10)}{20}}$   
 2. Applies to option 006 only.

18. Record the video feedthrough (%) in table 2-18.  
 19. Repeat steps 16 through 18 for the remaining CW frequencies in table 2-18.  
 20. On the test record, record the largest video feedthrough value noted on table 2-18.  
 21. For standard synthesizers or synthesizers with option 001 go to step 23.

22. If the synthesizer has option 006 installed, perform the following:
  - a. Repeat steps 16 through 18 with the synthesizer power level set to maximum specified leveled power for all of the CW frequencies in table 2-18.
  - b. On the test record, record the largest video feedthrough value (>10 dBm) noted on table 2-18.

### High Band Video Feedthrough

#### Note



Typically, high band video feedthrough is so small that it is difficult to measure. Use the following procedure to verify that the video feedthrough is negligible.

23. On the oscilloscope, set channel 1 to 1 mV/div.
24. On the synthesizer, set the first CW frequency in table 2-20.

Table 2-20. High Band Video Feedthrough Frequencies

Frequency (GHz)	Video Feedthrough (Vp)
5.0	_____
10.0	_____
15.0	_____
20.0	_____

25. On the oscilloscope, note the maximum voltage from the baseline. Video feedthrough  
 (Vp) = \_\_\_\_\_ Vp

Record this value in table 2-20.

26. Repeat steps 23 and 24 for each value in table 2-20.
27. Record the worst case value from table 2-20 on the test record.

### Related Adjustments

None

### In Case of Difficulty

See "TROUBLESHOOTING" in the *Assembly-Level Repair* manual.



## 15. AM ACCURACY

### Description and Procedure

This procedure measures the AM accuracy of the synthesizer. The local oscillator and mixer are used to down convert the synthesizer frequency to the frequency range of the measuring receiver (an HP 11793A Microwave Converter can be substituted for the mixer). The function generator provides AM modulation. The function generator signal level is adjusted for 30% AM as measured by the measuring receiver. The function generator signal level is checked for accuracy. A DVM may be necessary to measure the function generator output.

1. Turn on the equipment shown in figure 2-19. Preset the instruments and let them warm up for at least one hour.
2. On the measuring receiver:  
Calibrate and store the AM calibration factor.
3. Connect the equipment as shown in figure 2-19.

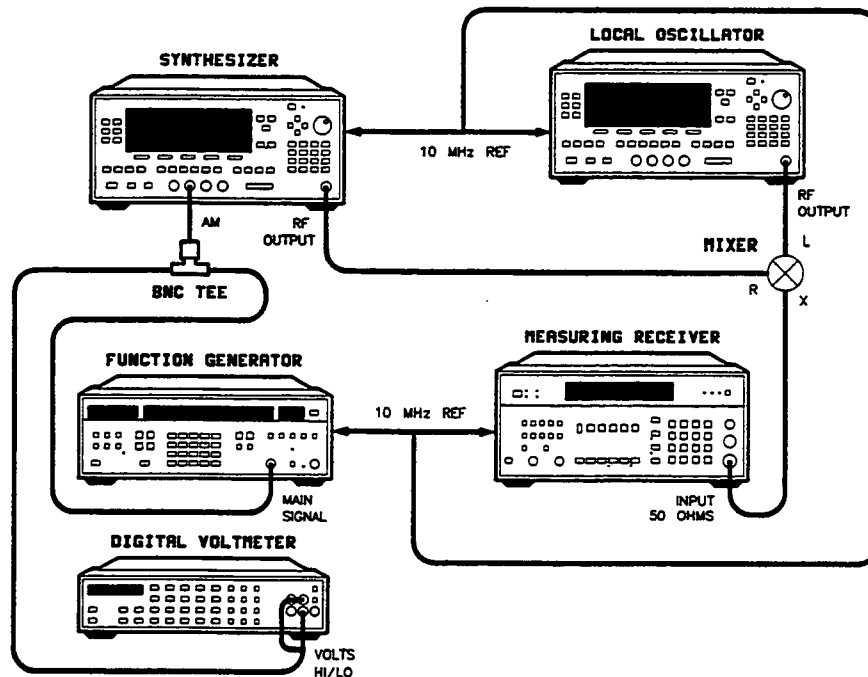

Figure 2-19. AM Accuracy Test Setup

4. On the synthesizer, set:

**CW** **5** **GHz**

**POWER LEVEL** **0** **dBm**

**USER CAL** **[AM Cal Menu]** **[AM BW Cal Always]** (asterisk on)

5. On the local oscillator, set:

CW Frequency: 5.1 GHz

RF: On

Power Level: 10 dBm

6. On the function generator, set:

Function: Sinewave

Frequency: 1 kHz

Amplitude: 600 mV p-p

DC Offset: 0 mV

7. On the measuring receiver, set:

HP Filter: 300 Hz

LP Filter: 3 kHz

Measurement: AM

Detector: Peak  $\pm$ /2 (both on)

Automatic Operation

8. On the synthesizer, turn on AM modulation. Set:

**MOD** **[AM On/Off 100%/V]** (asterisk on)

For instruments with Option 002, instead set:

**MOD** **[AM Menu]** **[AM On/Off Ext]** (asterisk on)

**[AM Type 100%/V]** (asterisk on)

9. Set the function generator amplitude for 30% AM modulation depth as indicated by the measuring receiver.
10. Record the function generator output as a percent of 600 mV p-p on the test record and compare it to the specification.

### **For Instruments with Option 002 only:**

11. On the synthesizer, turn external AM off and internal AM on. Set:

**MOD** **[AM Menu]** **[AM On/Off Ext]** (asterisk off)

**[AM On/Off Int]** (asterisk on)

12. On the synthesizer, set:

[Internal AM Rate] 1 kHz  
[Internal AM Depth] 30 enter

13. On the test record, record the modulation depth as indicated by the measuring receiver.

## Related Adjustments

Modulator Offset and Gain

## In Case of Difficulty

1. The AM input impedance is internally selectable to either  $50\Omega$  or  $2k\Omega$  (the factory-set value is  $50\Omega$ ). If the AM input is set for  $2k\Omega$ , and the function generator requires a  $50\Omega$  system, use a DVM to measure the AM input signal level while it is connected to the synthesizer.
2. See "TROUBLESHOOTING" in the *Assembly-Level Repair* manual.

## 16. AM BANDWIDTH

### Description and Procedure

This test verifies that the peak RF output power does not vary more than a specified amount over the specified amplitude modulation rate frequency range. The spectrum analyzer with the tracking generator operates as a network analyzer to measure the flatness. Flatness errors associated with the tracking generator and spectrum analyzer are calibrated out of the measurement.

1. Connect the equipment as shown in figure 2-20 with the tracking generator output connected to the 50 ohm input of the spectrum analyzer. Press **PRESET** and let the equipment warm up for at least one hour.

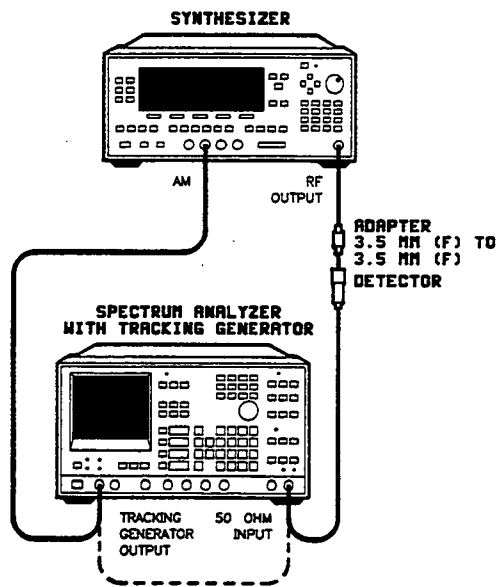

Figure 2-20. AM Bandwidth Test Setup

2. On the spectrum analyzer, set:

Start Frequency: 5 kHz  
 Stop Frequency: 250 kHz  
 Manual Sweep: 10 kHz  
 Scale Log: 1 dB/Division  
 Range: 5 dBm  
 Tracking Generator Amplitude: Maximum (600-700 mV p-p)

3. On the spectrum analyzer, clear trace A memory. Change the reference level, using the RPG knob, to position the trace on the center horizontal graticule.
4. Set the spectrum analyzer to continuous sweep. When a full sweep is completed, store trace A into trace B memory. Then display A minus B (turning off trace B). A straight line should be displayed.

The spectrum analyzer is now calibrated.

5. Connect the tracking generator output to the synthesizer's AM input and connect the synthesizer's RF output through the crystal detector to the spectrum analyzer's 50 ohm input.

6. On the synthesizer, set:

**USER CAL** [**AM CAL MENU**] [**AM BW CAL Always**] (asterisk on)

**CW** First synthesizer frequency in table 2-21

**POWER LEVEL** **0** **dBm**

**MOD** [**AM On/Off 100%V**] (asterisk on)

Table 2-21. Synthesizer Frequencies

Synthesizer Frequencies (GHz)	Maximum Difference
1.5*	_____
5.0	_____
9.0	_____
18.0	_____
* Not applicable for all models	

7. On the spectrum analyzer, clear and write to trace A. Change the reference level to center the trace on the display. If an over range occurs, turn the RPG knob in the opposite direction.

The display now shows the synthesizer AM flatness from 5 kHz to 250 kHz.

8. Use the marker offset feature of the spectrum analyzer to measure AM flatness. Set:

**MANUAL** **100** **kHz** **OFFSET** (light on) **ENTER OFFSET** **MARKER**

Use the RPG knob to tune the offset over the full frequency range. The offset amplitude relative to 10 kHz is displayed in the upper right side of the CRT.

Determine the maximum and minimum deviation points from the 10 kHz reference. Record the value of the difference in table 2-21.

9. Repeat steps 6 through 8 for the remaining frequencies in table 2-21.
10. Record the worst case value from table 2-21 on the test record.

### **Related Adjustments**

None

### **In Case of Difficulty**

See "TROUBLESHOOTING" in the *Assembly-Level Repair* manual.

## 17. AM DYNAMIC RANGE

### Description and Procedure

In this procedure, a function generator is used to provide a dc voltage to the synthesizer's AM input. The synthesizer is set to 0 dBm output power. AM is enabled and a dc voltage is applied. The dc voltage is set for maximum AM without an overmodulation indication to drive the synthesizer's modulator to the edge of distortion. The output power is measured with a power meter. A measurement is made in 1 GHz steps across the synthesizer's frequency range. This equipment lets you measure down to  $-30$  dBm. If you reach this level before the synthesizer overmodulates, the power meter will indicate an under range measurement.

This procedure is repeated using the deep AM function in the search ALC mode. A spectrum analyzer is used in place of the power meter to make the deep AM measurement. This equipment allows you to measure down to approximately  $-65$  dBm. If your synthesizer does not overmodulate by this point, and you wish to measure the power level just before overmodulation, use a power supply to increase the dc voltage supply to the AM input.

### Caution



Do not exceed  $-15$  V dc to the AM input or damage will occur.

1. Preset the instruments shown in figure 2-21 and let them warm up for at least one hour.

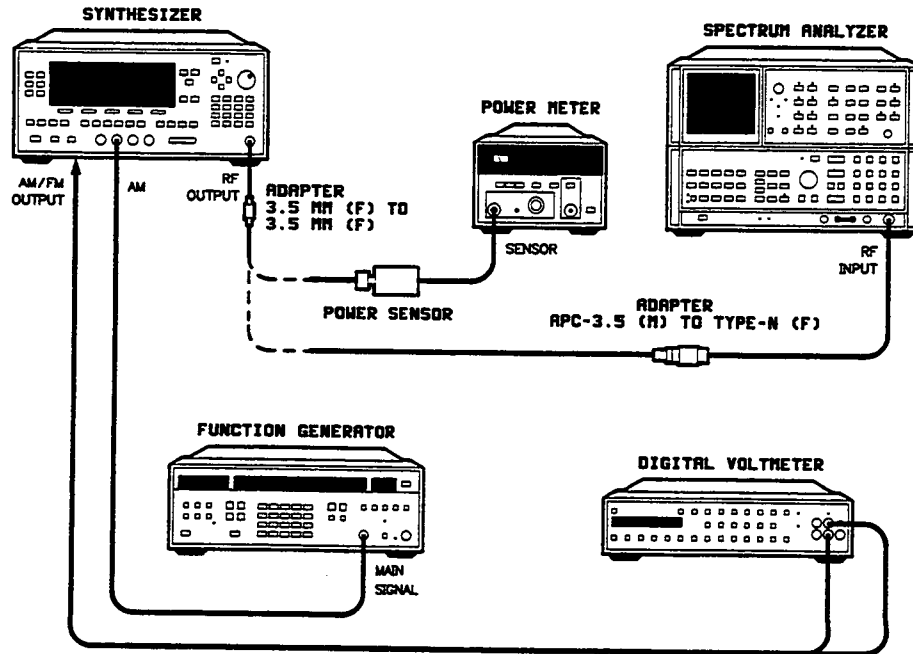

Figure 2-21. AM Dynamic Range Test Setup

2. To achieve peak power, turn on RF peaking. Set:  
**USER CAL** **[Tracking Menu]** **[Peak RF Always]** (asterisk on)
3. Zero and calibrate the power meter/sensor.
4. Connect the equipment as shown in figure 2-21 with the power sensor connected to the synthesizer's RF OUTPUT.
5. On the synthesizer, set:  
**CW** **1** **GHz** (Set to 2 GHz for synthesizers with lowest start frequency of 2 GHz)  
**FREQUENCY** **MENU** **[Up/Dn Size CW]** **1** **GHz**  
**POWER** **MENU** **[Uncoupl Atten]** (option 001 only)  
**POWER LEVEL** **-** **10** **dBm**  
**MOD** Verify that all modulation is off. (No asterisks next to key labels.)

### Note



For synthesizers with Option 002, if modulation is on, an "AM," "FM," or "PLS" message will be displayed.

6. On the power meter, set:  
Mode: dBm  
Cal Factor %: Cal factor corresponding to the synthesizer's CW frequency
7. On the function generator, turn off all waveforms and set:  
dc Offset: -1.5 V dc

### Normal AM Dynamic Range

8. On the synthesizer, turn on AM modulation to 10 dB/V:  
**MOD** **[AM On/Off 10dB/V]** (asterisk on)  
or, for synthesizers with Option 002, set:  
**MOD** **[AM Menu]** **[AM On/Off Ext]** (asterisk on)  
**[AM Type 10 dB/V]** (asterisk on)
9. Decrease the function generator output just until the OVERMOD message turns on. Then increase the signal until the OVERMOD message turns off. (The more negative the signal applied to the modulator is, the more the RF output level decreases.)



- Wait for the power meter to settle then note the power meter reading. If the power meter reads under range, record  $< -30$  dB.

Power Meter Reading

1 GHz _____	11 GHz _____
2 GHz _____	12 GHz _____
3 GHz _____	13 GHz _____
4 GHz _____	14 GHz _____
5 GHz _____	15 GHz _____
6 GHz _____	16 GHz _____
7 GHz _____	17 GHz _____
8 GHz _____	18 GHz _____
9 GHz _____	19 GHz _____
10 GHz _____	20 GHz _____

- Repeat steps 9 and 10 from 2 to 20 GHz, in 1 GHz steps. Change the power meter cal factor % as required.
- Record the worst case value from step 10 on the test record.

**Note**



For synthesizers *without* Option 002, continue with "Deep AM Dynamic Range," step 20.

**Internal AM Dynamic Range (Option 002)**

- On the synthesizer, set:

**[CW]** **[1]** **[GHz]**

**[MOD]** **[AM Menu]** **[AM On/Off Int]** (asterisk on)

**[Internal AM Rate]** **[1]** **[kHz]**

**[MOD]** **[Monitor Menu]** **[Mod Out On/Off AM]** (asterisk on)

- Set the DVM for an AC rms measurement.

- On the synthesizer, set:

**[MOD]** **[AM Menu]** **[Internal AM Depth]**

Adjust for maximum AM depth without overmodulation. If you are unable to get an "OVER-MOD" indication, set the depth to the maximum.

16. Record the DVM AC rms value in the following table.

CW Freq.	AC Volts	DC Volts	CW Freq.	AC Volts	DC Volts
1 GHz	_____	_____	11 GHz	_____	_____
2 GHz	_____	_____	12 GHz	_____	_____
3 GHz	_____	_____	13 GHz	_____	_____
4 GHz	_____	_____	14 GHz	_____	_____
5 GHz	_____	_____	15 GHz	_____	_____
6 GHz	_____	_____	16 GHz	_____	_____
7 GHz	_____	_____	17 GHz	_____	_____
8 GHz	_____	_____	18 GHz	_____	_____
9 GHz	_____	_____	19 GHz	_____	_____
10 GHz	_____	_____	20 GHz	_____	_____

17. Set the DVM for a DC measurement and record this value also.

18. Repeat steps 14 through 17 for each frequency listed in the table.

19. Determine which CW frequency from the table has the smallest absolute sum of AC and DC voltage. Calculate the dynamic range for that absolute value as follows (note that the power setting is in dBm):

$$\text{AM Dynamic Range (dBm)} = \text{Power Setting} - 10 [\text{DC DVM value} + (1.414 \times \text{AC DVM value})]$$

Record this value on the test record at the end of this section.

### Deep AM Dynamic Range

20. Disconnect the power sensor from the synthesizer and connect the spectrum analyzer as shown in figure 2-21.

21. On the synthesizer, set:

**CW** **1** **GHz** (Set to 2 GHz for synthesizers with lowest start frequency of 2 GHz)

**[AM On/Off 10dB/V]** (asterisk off)

**POWER LEVEL** **-** **15** **dBm**

or for synthesizers with Option 002:

**[AM Type 10 dB/V]** (asterisk off)

22. On the spectrum analyzer, set:

Center Frequency: 1 GHz  
 Frequency Span: 1 MHz  
 CF Step Size: 1 GHz  
 Reference Level: 5 dBm  
 Scale Log: 5 dB/Division

23. Center the signal on the spectrum analyzer with the center frequency control.

24. On the synthesizer, set:

**[AM On/Off 10dB/V]** (asterisk on)

**[Deep AM]** (asterisk on)

or for synthesizers with Option 002:

**[AM Type 10 dB/V]** (asterisk off)

**[Deep AM]** (asterisk on)

25. Change the spectrum analyzer reference level to  $-40$  dBm.

### Note



Make the following measurements as quickly as possible since the signal amplitude is subject to drift when you use deep AM at low levels.

26. Set the function generator for the minimum signal output without causing an OVERMOD message on the synthesizer.

27. Note the RF signal level.

#### RF Signal Level

1 GHz _____	11 GHz _____
2 GHz _____	12 GHz _____
3 GHz _____	13 GHz _____
4 GHz _____	14 GHz _____
5 GHz _____	15 GHz _____
6 GHz _____	16 GHz _____
7 GHz _____	17 GHz _____
8 GHz _____	18 GHz _____
9 GHz _____	19 GHz _____
10 GHz _____	20 GHz _____

28. On the synthesizer, turn off modulation. Select:

**[AM On/Off 10dB/V]** (asterisk off)

or for synthesizers with Option 002:

**[AM Type 10 dB/V]** (asterisk off)

29. Step the synthesizer and spectrum analyzer CW and center frequencies in 1 GHz steps. Turn modulation back on and repeat steps 26 through 28 until 20 GHz is measured.

30. Record the worst case value from step 27 on the test record.

### Note



Synthesizers *without* Option 002 should continue with "Related Adjustments" and "In Case of Difficulty" as required. Do not perform steps 31 through 37.

## Internal Deep AM Dynamic Range (Option 002)

31. On the synthesizer, set:

**CW** **1** **GHz**

**MOD** **[AM Menu]** **[AM On/Off Int]** (asterisk on)

**[Internal AM Rate]** **1** **kHz**

**MOD** **[Monitor Menu]** **[Mod Out On/Off AM]** (asterisk on)

32. Set the DVM for an AC rms measurement.

33. On the synthesizer, set:

**MOD** **[AM Menu]** **[Internal AM Depth]**

Adjust for maximum AM depth without overmodulation. If you are unable to get an "OVER-MOD" indication, set the depth to the maximum.

34. Record the DVM AC rms value in the following table.

CW Freq.	AC Volts	DC Volts	CW Freq.	AC Volts	DC Volts
1 GHz	_____	_____	11 GHz	_____	_____
2 GHz	_____	_____	12 GHz	_____	_____
3 GHz	_____	_____	13 GHz	_____	_____
4 GHz	_____	_____	14 GHz	_____	_____
5 GHz	_____	_____	15 GHz	_____	_____
6 GHz	_____	_____	16 GHz	_____	_____
7 GHz	_____	_____	17 GHz	_____	_____
8 GHz	_____	_____	18 GHz	_____	_____
9 GHz	_____	_____	19 GHz	_____	_____
10 GHz	_____	_____	20 GHz	_____	_____

35. Set the DVM for a DC measurement and record this value also.

36. Repeat steps 32 through 35 for each frequency listed in the table.

37. Determine which CW frequency from the table has the smallest absolute sum of AC and DC voltage. Calculate the dynamic range for that absolute value as follows (note that the power setting is in dBm):

$$\text{AM Dynamic Range (dBm)} = \text{Power Setting} - 10 [\text{DC DVM value} + (1.414 \times \text{AC DVM value})]$$

Record this value on the test record at the end of this section.

## **Related Adjustments**

Modulator Offset and Gain  
Modulator Generator Adjustment (Option 002)

## **In Case of Difficulty**

1. Make sure that the most negative voltage *without* an OVERMOD message is applied.
2. See "TROUBLESHOOTING" in the *Assembly-Level Repair* manual.

## 18. FM ACCURACY

### Description and Procedure

Use this procedure to measure the FM accuracy of the synthesizer. With the synthesizer set to an FM sensitivity of 10 MHz/V, and the function generator providing an FM modulation index of 2.404, the RF output should be a null. You then adjust the function generator amplitude for the Bessel null and record the difference between signals.

### Note



Since the modulation frequency for external FM is 1 MHz, this procedure relies on the voltage-setting accuracy of the function generator (the frequency is too high for a DVM, and an oscilloscope is not accurate enough.)

### External FM

1. Connect the equipment as shown in figure 2-22. Preset all instruments and let them warm up for at least one hour.

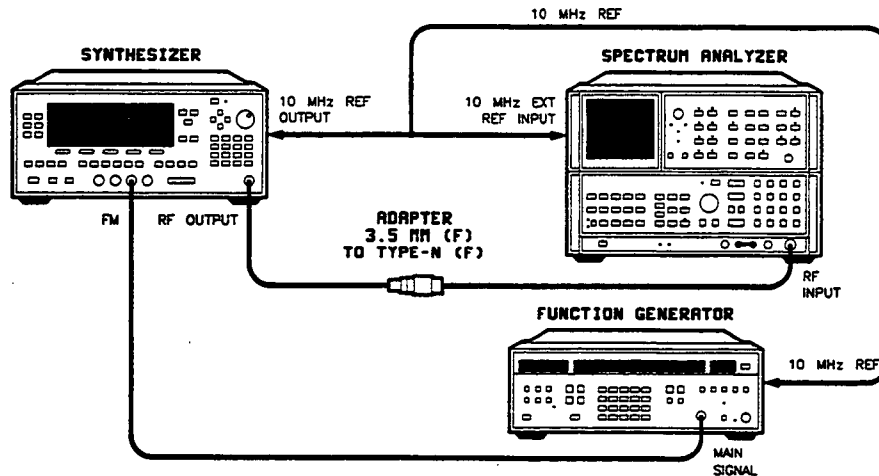

Figure 2-22. FM Accuracy Test Setup

2. To achieve peak power, turn on RF peaking. Select:  
**USER CAL** [Tracking Menu] [Peak RF Always] (asterisk on)
3. On the synthesizer, set:  
**CW** First synthesizer frequency in table 2-22  
**POWER LEVEL** Set the specified maximum leveled power

Table 2-22. Synthesizer Frequencies

Synthesizer Frequencies (GHz)	External FM Error (%)	Internal FM Error (%)
1.0*		
5.0		
10.0		
16.0		
20.0		
* Not applicable for all models.		

4. On the function generator, set:

Function: Sine wave  
 Frequency: 1 MHz  
 Amplitude: 480.8 mV p-p (169.96 mV rms)  
 DC Offset: 0 V

5. On the spectrum analyzer, set:

Reference Level: 0 dBm  
 Attenuator: Auto  
 Center Frequency: Same frequency as in step 3  
 Frequency Span: 50 kHz  
 Resolution Bandwidth: 3 kHz  
 Video Bandwidth: 1 kHz  
 Sweep Time: Auto  
 Sweep: Continuous

6. Center the signal on the spectrum analyzer display using the center frequency function.

7. Turn on the synthesizer modulation. Set:

**MOD** [FM On/Off 100 kHz] (asterisk on)

or for synthesizers with Option 002, set:

**MOD** [FM Menu] [FM On/Off Ext] (asterisk on)

8. Adjust the function generator amplitude to minimize the amplitude of the signal on the spectrum analyzer.

9. Calculate the percentage of error as follows:

$$\text{Error (\%)} = [(480.8 \text{ mV p-p} - \text{New Amplitude})/480.8 \text{ mV p-p}] \times 100.$$

10. Record the error in table 2-22.
11. Turn off the synthesizer FM modulation. Select:  
     [FM On/Off 100 kHz] (asterisk off)  
     or for synthesizers with Option 002, select:  
     [FM On/Off Ext] (asterisk off)
12. Repeat steps 6 through 11 at the synthesizer (and spectrum analyzer) frequencies in table 2-22.
13. Record the worst case value from table 2-22 on the test record.

### Internal FM (Option 002 only)

14. On the synthesizer, set:  
     [CW] First synthesizer frequency in table 2-22  
     [MOD] [FM Menu] [FM On/Off Ext] (asterisk off)
15. Set the spectrum analyzer center frequency to the same frequency as the synthesizer.
16. Center the signal on the spectrum analyzer display using the center frequency function.
17. On the synthesizer, set:  
     [MOD] [FM Menu] [FM On/Off Int] (asterisk on)  
     [Internal FM Rate] [1] [MHz]  
     [Internal FM Dev] [2.404] [MHz]
18. Adjust the internal FM deviation on the synthesizer to minimize the amplitude of the carrier on the spectrum analyzer.
19. Calculate the percentage of error as follows:  
     Error (%) = [(2.404 MHz - New FM Deviation)/2.404 MHz] x 100.
20. Record the error in table 2-22.
21. Turn off the internal FM modulation. Select:  
     [FM On/Off Int] (asterisk off)
22. Repeat steps 15 through 21 at the synthesizer (and spectrum analyzer) frequencies in table 2-22.
23. Record the worst case "Internal FM Error (%)" from table 2-22 on the test record card.



## **Related Adjustments**

FM Gain  
Modulation Generator (Option 002)  
Modulation Generator Flatness (Option 002)

## **In Case of Difficulty**

See "TROUBLESHOOTING" in the *Assembly-Level Repair* manual.

## 19. FM BANDWIDTH

### Description and Procedure

Use this procedure to verify that the RF output power does not vary more than a specified amount over the specified frequency modulation rate frequency range. A low frequency spectrum analyzer with a tracking generator operates as a network analyzer to measure the FM flatness. Flatness errors associated with the tracking generator and spectrum analyzer are calibrated out of the measurement. Flatness errors due to the power splitter and microwave amplifier are minimized by external leveling at the amplifier. The delay line discriminator is used to demodulate the FM from the RF carrier. It also provides an input to the spectrum analyzer that is equivalent to the tracking generator frequency and proportional in power to the synthesizer RF output.

The delay line discriminator is formed by driving a mixer with a modulated carrier into the LO port, and a delayed carrier into the RF port. The delay is produced with a cable of approximately 3 feet in length. With this setup, the mixer responds to phase differences between the two inputs. The cable has a constant time delay and, as the carrier frequency is frequency-modulated, a linear phase shift occurs between the mixer inputs. Since the mixer inputs are in quadrature, the mixer operates as a phase detector that amplitude tracks the RF input (synthesizer power) and has an output frequency corresponding to the FM rate (tracking generator frequency).

1. Connect the equipment as shown in figure 2-23 with the tracking generator output connected to the channel 1 input of the oscilloscope (A). A DVM can be used in place of the oscilloscope for RMS measurements. Preset all the equipment and let them warm up at least one hour.

2. To achieve peak power, turn on RF peaking. Set:

**USER CAL** [*Tracking Menu*] [*Peak RF Always*] (asterisk on)

3. On the spectrum analyzer, set:

Center frequency: 100 kHz  
Frequency Span: 0 Hz

Set the spectrum analyzer tracking generator to 200 mV p-p (141.4 mV rms). Choose the alternate detector if your tracking generator has an alternate detector that improves the low-end flatness.

4. Connect the tracking generator output to the 50 ohm input of the spectrum analyzer (B). On the spectrum analyzer, set:

Start Frequency: 50 kHz  
Stop Frequency: 5 MHz  
Resolution Bandwidth: 10 kHz  
Video Bandwidth: 1 kHz  
Sweep: Continuous  
Scale Log: 2 dB/Division  
Range: 5 dBm

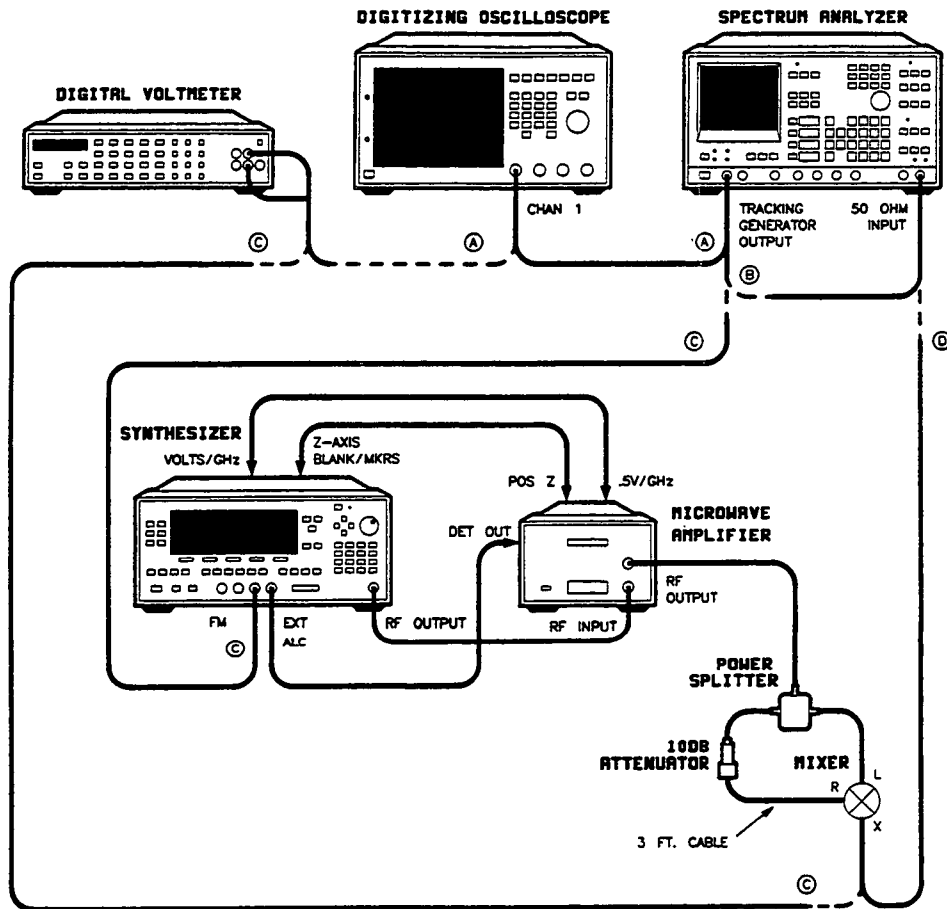

Figure 2-23. FM Bandwidth Test Setup

5. On the spectrum analyzer, clear trace A memory. Change the reference level, using the RPG knob, to position the trace on the center horizontal graticule.
6. When a full sweep is completed, store trace A into trace B memory. Then display A minus B (turning off trace B). A straight line should be displayed.

**Find Quadrature**

7. Connect the tracking generator output to the synthesizer's FM input and connect the mixer's IF output to the DVM's VOLTS HI/LO input (C).
8. On the synthesizer, set:
  - CW** First synthesizer frequency in table 2-23
  - ALC** [**Leveling Point ExtDet**] [**Coupling Factor**] **-** **16** **dB**
  - POWER LEVEL** Set the power so that the microwave amplifier displays an output of 16 dBm.

*Table 2-23. Synthesizer Frequencies*

Synthesizer Frequencies (GHz)	Maximum Difference
1.5*	_____
5.0	_____
9.0	_____
18.0	_____
* Not applicable for all models.	

9. On the spectrum analyzer, set:
  - Center Frequency: 100 kHz
  - Frequency Span: 0 Hz
10. On the synthesizer, press **CW** and use the left arrow key to position the cursor in the 1 MHz position (one digit left of the decimal point). Use the rotary knob to adjust the CW frequency for 0V on the DVM.

**DC FM Flatness (Unlocked)**

11. Move the mixer's IF output from the DVM to the spectrum analyzer's 50Ω input.
12. On the synthesizer, turn on FM DC. Select:
  - MOD** [**FM On/Off DC**] (asterisk on)
13. On the spectrum analyzer, set:
  - Start Frequency: 50 kHz
  - Stop Frequency: 5 MHz
  - Scale Log: 2 dB/Division
  - Trace: A - B

Change the reference level to center the trace on the display.

14. On the spectrum analyzer, clear trace A memory. Change the reference level, using the RPG knob, to position the trace on the center horizontal graticule. If an over-range occurs, turn the knob in the opposite direction.
15. The display now shows the synthesizer FM flatness from dc to 5 MHz.  
  
Use markers to find the maximum and minimum points on the trace. Record the value of the difference in table 2-23.
16. Repeat steps 7 through 15 at the synthesizer frequencies in table 2-23.
17. Record the worst case value from table 2-23 on the test record.

### **Related Adjustments**

FM Gain

### **In Case of Difficulty**

See "TROUBLESHOOTING" in the *Assembly-Level Repair* manual.

## 20. MAXIMUM FM DEVIATION

### Description and Procedure

In this procedure, the synthesizer's RF output is monitored directly on a spectrum analyzer for low FM rates. The FM amplitude is increased until the maximum deviation exceeds the specification.

For higher FM rates, the FM rate is set so that a Bessel null occurs when the RF peak deviation equals the specification. The modulation amplitude is increased in order to pass through the correct Bessel null for the FM rate used and the peak deviation specified.

1. Connect the equipment as shown in figure 2-24. Preset all the instruments and let them warm up for at least one hour.

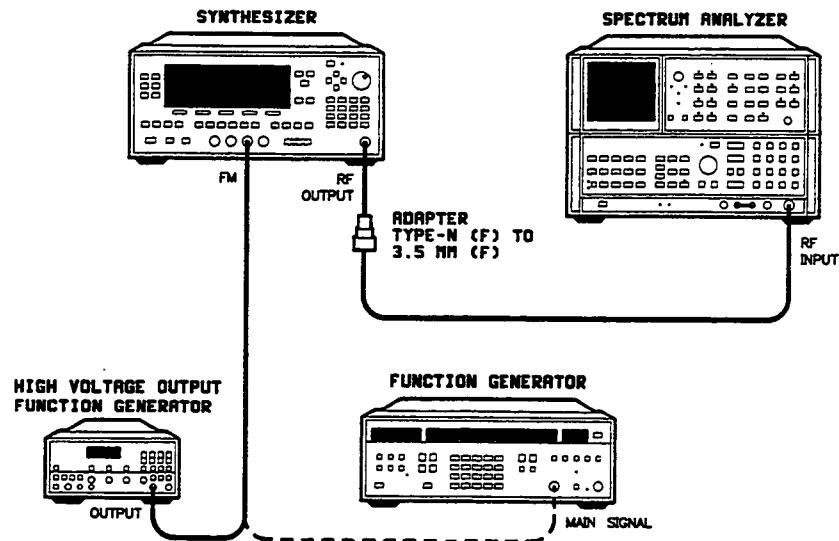

Figure 2-24. Maximum FM Deviation Test Setup

#### DC FM ( $\leq 100$ Hz)

2. On the synthesizer, set:

**CW** **1** **GHz**

**FREQUENCY** **MENU** **[Up/Dn Size CW]** **1** **GHz**

**USER CAL** **[Tracking Menu]** **[Peak RF Always]** (asterisk on)

3. On the spectrum analyzer, set:

Center Frequency: 1 GHz  
Frequency Span: 187.5 MHz  
Center Frequency Step Size: 1 GHz  
Reference Level: 10 dBm

4. Connect the high voltage output (16 V p-p) function generator and set it as follows:

Function: Sinewave  
Frequency: 100 Hz  
Amplitude: Minimum

5. Center the signal on the spectrum analyzer display by adjusting the center frequency. Set the spectrum analyzer to maximum hold.

6. On the synthesizer, set:

**MOD** **[FM On/Off DC]** (asterisk on)

or for synthesizers with Option 002, set:

**MOD** **[FM Menu]** **[FM On/Off Ext]** (asterisk on)  
**[FM Coupling DC]** (asterisk on)

## Note



The function generator must be capable of supplying >16 V p-p into 50Ω to obtain sufficient FM deviation for this step.

7. Increase the function generator amplitude until the width of the signal displayed exceeds eight divisions on the spectrum analyzer. Record PASS if the signal exceeds eight divisions with no unlock or overmod message on the synthesizer. Record FAIL if not.

1 GHz \_\_\_\_\_ 9 GHz \_\_\_\_\_  
5 GHz \_\_\_\_\_ 18 GHz \_\_\_\_\_

8. On the synthesizer, set:

**[FM On/Off DC]** (asterisk off)

or for synthesizers with Option 002, set:

**[FM On/Off Ext]** (asterisk off)

9. On the spectrum analyzer, clear and write to trace A.
10. Decrease the function generator amplitude to minimum.
11. Repeat steps 5 through 10 for synthesizer and spectrum analyzer frequencies of 5, 9, and 18 GHz.

12. Circle PASS on the test record if all the results in step 7 are PASS. If not, circle FAIL on the test record.

**Note**



For synthesizers *without* Option 002, continue with "AC FM (at 100 kHz)", step 23.

**Internal DC FM (< = 100 Hz) (Option 002)**

13. On the synthesizer, set:

**CW** **1** **GHz**

**MOD** **[FM Menu]** **[FM On/Off Ext]** (asterisk off)

14. On the spectrum analyzer, set:

Center Frequency: 1 GHz

Frequency Span: 25 MHz

15. Center the signal on the spectrum analyzer display by adjusting the center frequency.

16. On the synthesizer, set:

**MOD** **[FM Menu]** **[FM On/Off Int]** (asterisk on)

**[Internal FM Rate]** **.1** **kHz**

**[Internal FM Deviation]** **10** **MHz**

**[FM Coupling DC]** (asterisk on)

17. Set the spectrum analyzer to maximum hold.

18. Use the spectrum analyzer delta mkr function to measure the total FM deviation (deviation above and below the center frequency). Divide this deviation by 2 to get the actual FM deviation. Record the actual FM deviation in the following table.

CW Frequency	Actual FM Deviation
1 GHz	_____
5 GHz	_____
9 GHz	_____
18 GHz	_____

19. On the synthesizer, set:

**[FM On/Off Int]** (asterisk off)

20. On the spectrum analyzer, clear and write to trace A.



21. Repeat steps 15 through 20 for synthesizer and spectrum analyzer frequencies of 5, 9, and 18 GHz.
22. On the test record at the end of this section, enter the smallest FM deviation from step 18.

#### AC FM (at 100 kHz)

**NOTE:** Maximum FM deviation for a 100 kHz rate is limited to a modulation index of 5 times n, where n = frequency band. The modulation index is equivalent to deviation/rate.

23. On the synthesizer, set:

**CW** **1** **GHz**

24. On the spectrum analyzer, set:

Center frequency: 1 GHz  
Frequency Span: 1 MHz  
Reference Level: 10 dBm

Clear all data from the display.

25. Center the signal on the analyzer display.
26. Connect the synthesized function generator and set it as follows:

Function: Sine wave  
Frequency (FM Rate): 100 kHz  
Amplitude: 1 mV

27. On the synthesizer, set:

**MOD** [**FM on/Off 100 kHz**] (asterisk on)

This activates FM sensitivity. Use the down arrow key to set FM sensitivity to 1.00 MHz/V.

28. On the function generator, set:

Amplitude (Calculated Null Voltage): 271 mV<sub>rms</sub>

Use the **AMPTD CAL** key to do an amplitude calibration. Use the arrow keys to adjust the amplitude to achieve a null of the 1<sup>st</sup> sideband (Sideband Nulled).

#### Note



The sidebands may not respond to increases and decreases of the FM Input Voltage symmetrically. In this case, take the average of the voltages that cause the lower sideband and upper sideband to null.

29. Record the Actual Null Voltage in the space provided in table 2-24.
30. Calculate the actual FM sensitivity using the formula:  
Actual FM Sensitivity = (Calculated Null Voltage/Actual Null Voltage) (Set FM Sensitivity)  
Record this value in the space provided in table 2-24.

31. On the function generator, increase the amplitude (FM input voltage) until the synthesizer displays the UNLOCK message. Decrease the FM Input Voltage just until the UNLOCK message turns off.
32. Record the FM input voltage in the Maximum FM Voltage column of table 2-24.
33. Calculate the maximum FM deviation using the formula:  

$$\text{Max FM Deviation} = (\text{Actual FM Sensitivity})[(1.414)(\text{Max FM Voltage})]$$
34. Record the maximum FM deviation in the appropriate column of the test record.
35. Repeat steps 23 through 34 for all the synthesizer settings indicated in table 2-24.

### Note



Remember to use the set FM sensitivity as a multiplier when calculating the actual FM sensitivity.

*Table 2-24. FM Deviation Frequencies and Settings*

Synthesizer Settings		Spectrum Analyzer Settings		Sideband Nulled	Function Generator Settings		Readings and Calculations			
CW Frequency (GHz)	FM Sensitivity (MHz/Volt)	Center Frequency (GHz)	Frequency Span (MHz)		Frequency FM Rate (MHz)	Amplitude Calculated Null Voltage (mV <sub>rms</sub> )	Actual Null Voltage (mV <sub>rms</sub> )	Actual FM Sensitivity (MHz)	Maximum FM Voltage (mV <sub>rms</sub> )	Maximum Internal FM Deviation
1	1	1	1	1	0.1	271				
5	1	5	1	1	0.1	271				
9	1	9	1.2	5	0.1	621				
17	1	17	1.3	6	0.1	706				
1	10	1	5	1	1	271				
5	10	5	5	1	1	271				
1	10	1	1	CARRIER	3	510				
5	10	5	1	CARRIER	3	510				

$$\text{Actual FM Sensitivity} = \left( \frac{\text{Calculated Null Voltage}}{\text{Actual Null Voltage}} \right) (\text{Set FM Sensitivity})$$

$$\text{Max FM Deviation} = (\text{Actual FM Sensitivity}) [(1.414) (\text{Max FM Voltage})]$$

## Note



Synthesizers *without* Option 002 should continue with "Related Adjustments" and "In Case of Difficulty" as required. Do not perform steps 36 through 41.

### Internal AC FM (at 100 kHz) (Option 002)

36. On the synthesizer, set:

**CW** **1** **GHz**

**MOD** **[FM Menu]** **[FM On/Off Ext]** (asterisk off)

**[FM On/Off Int]** (asterisk on)

**[Internal FM Rate]** **.1** **kHz**

**[Internal FM Dev]** **0** **MHz**

**[FM Coupling 100kHz]** (asterisk on)

37. Increase the internal FM deviation until the synthesizer displays an UNLOCK message. Decrease the internal FM deviation just until the UNLOCK message turns off.

38. Record the displayed FM deviation in the "Maximum Internal FM Deviation" column of table 2-24.

39. Calculate the maximum FM deviation using the formula:

Maximum FM Deviation = (Actual FM Sensitivity/Set FM Sensitivity) x (Displayed Maximum FM Deviation)

40. Record the maximum FM deviation on the test record located at the end of this section.

41. Repeat steps 36 through 40 for all the synthesizer settings in table 2-24 where the FM rate  $\leq$  1 MHz.

### Related Adjustments

FM Gain

Modulation Generator

Modulation Generator Flatness

### In Case of Difficulty

If the synthesizer remains *unlocked*, turn AC FM off and begin the procedure from step 13 for the CW frequency in question.

See "TROUBLESHOOTING" in the *Assembly-Level Repair Manual*.

## 21. Internal Pulse Accuracy (Option 002)

### Description and Procedure

This performance test uses an oscilloscope to measure the pulse width of the output of the modulation generator (not the pulse width of the RF output).

1. Connect the equipment as shown in Figure 2-25 using a 1:1 probe. Preset all instruments and let them warm up for at least one hour.

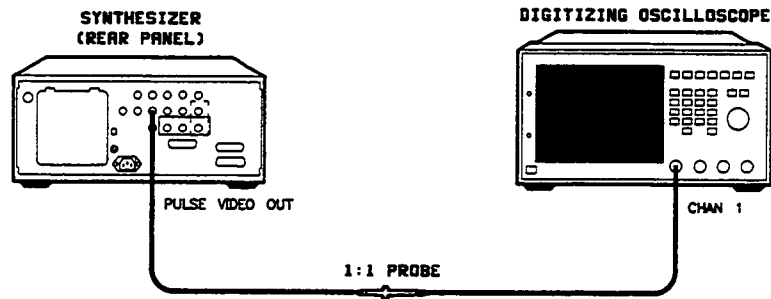

Figure 2-25. Pulse Accuracy Test Setup

2. On the synthesizer, set:  
[MOD] [Pulse Menu] [Pulse On/Off Int] (asterisk on)  
[Internal Menu] [Internal Pulse Width] [25] [ns]  
[Internal Pulse Period] [300] [ns]

3. On the oscilloscope, set:

Channel 1:

Display	On
Volts/Division	500 mV
Input Coupling	dc
Input Impedance	50Ω

TIMEBASE:

Time/Division	10 ns
Delay Reference	center
Sweep	auto

TRIGGER:

Trigger Mode	Edge
Trig Src	Chan 1
Slope	Pos

DISPLAY:

Display Mode	Repetitive
Averaging	Off
Display Time	0.2 s

4. Use the oscilloscope to measure the width of the pulse. Record the value measured on the performance test record located at the end of this chapter.
5. On the synthesizer, change the pulse width to 50 ns. Set:  
**[Internal Pulse Width] (50) (ns)**
6. Use the oscilloscope to measure the width of the pulse. Record the value measured on the performance test record located at the end of this chapter.

## Related Adjustments

None

## In Case of Difficulty

See "Troubleshooting" in the *Assembly-Level Repair* manual.

## 22. Modulation Meter (Option 002)

### Description and Procedure

The modulation meter measures and displays the value of the externally generated amplitude or frequency modulation. This procedure determines the accuracy of the modulation meter.

1. Connect the equipment as shown in Figure 2-26. Preset the instruments and let them warm up for at least one hour.



Figure 2.26. Modulation Meter Test Setup

2. Set the function generator for a 100 kHz, 600 mV p-p, sine wave output signal.
3. On the synthesizer, turn on external AM modulation and turn on the AM meter function. Set:  
**MOD** [AM Menu] [AM On/Off Ext] (asterisk on).  
**PRIOR** [Monitor Menu] [Meter On/Off AM] (asterisk on).
4. Record the AM METER value in the performance test record at the end of this section.
5. Set the function generator for a 1 kHz, 1.800 V p-p, sinewave output signal.
6. Record the AM METER value in the performance test record.
7. Disconnect the function generator from the AM input and connect it to the FM input.
8. On the synthesizer, turn off external AM, turn on external FM, set the FM sensitivity to 1 MHz/V, and turn on the FM meter function. Set:  
**MOD** [AM Menu] [AM On/Off Ext] (asterisk off).  
**PRIOR** [FM Menu] [FM On/Off Ext] (asterisk on).  
**1** [MHz].  
**PRIOR** [Monitor Menu] [Meter On/Off FM] (asterisk on).

9. Set the function generator for a 1 kHz, 10 V p-p, sine wave output signal.
10. Record the FM METER value in the performance test record.
11. Set the function generator for a 100 kHz, 2 V p-p, sine wave output signal.
12. Record the FM METER value in the performance test record.

### **Related Adjustments**

None

### **In Case of Difficulty**

See "Troubleshooting" in the *Assembly-Level Repair manual*.

**Table 2-25. Test Record for HP 83620A and 83622A (1 of 8)**

Test Facility: _____	Report Number _____
_____	Date _____
_____	Customer _____
_____	Tested by _____
Model _____	Ambient temperature _____ °C
Serial Number _____	Relative humidity _____ %
Options _____	Line frequency _____ Hz (nominal)
Firmware Revision _____	
<b>Special Notes: Substitute <math>\geq 2.0</math> GHz for <math>\geq 2.3</math> GHz at footnote 1 for HP 83622A only.</b>	
_____	
_____	
_____	
_____	
_____	



**Table 2-25. Test Record for HP 83620A and 83622A (2 of 8)**

Model _____	Report Number _____	Date _____	
<b>Test Equipment Used</b>	<b>Model Number</b>	<b>Trace Number</b>	<b>Cal Due Date</b>
1. Digital Oscilloscope	_____	_____	_____
2. Measuring Receiver	_____	_____	_____
3. Power Sensor	_____	_____	_____
4. Power Meter	_____	_____	_____
5. Microwave Spectrum Analyzer	_____	_____	_____
6. Function Generator	_____	_____	_____
7. _____	_____	_____	_____
8. _____	_____	_____	_____
9. _____	_____	_____	_____
10. _____	_____	_____	_____
11. _____	_____	_____	_____
12. _____	_____	_____	_____
13. _____	_____	_____	_____
14. _____	_____	_____	_____
15. _____	_____	_____	_____
16. _____	_____	_____	_____
17. _____	_____	_____	_____

Table 2-25. Test Record for HP 83620A and 83622A (3 of 8)

Model		Report No.			Date
Test No.	Test Description	Minimum Spec.	Results	Maximum Spec.	Measurement Uncertainty
1.	Internal Timebase: Aging Rate 7. Calculated Rate		_____	5x10 <sup>-10</sup> /day	
2.	Swept Frequency Accuracy Worst Case Value: 10. Start Freq _____ Stop Freq _____		_____	0.1% of sweep	
3.	Frequency Switching Time 8. CW Step: 0.01 to 20 GHz 12.5 to 20 GHz 16. Stepped Sweep 25. Frequency List		_____	70 ms	
			_____	70 ms	
			_____	5 ms	
			_____	70 ms	
4.	Power Accuracy 14. <2.3 GHz: Power >-10 dBm ≥2.3 <sup>1</sup> and ≤20 GHz: Power >-10 dBm	-0.6 dB	_____	+0.6 dB	
		-0.7 dB	_____	+0.7 dB	
5.	Power Flatness 5. <2.3 GHz 6. ≥2.3 <sup>1</sup> and ≤20 GHz	-0.5 dB	_____	+0.5 dB	
		-0.6 dB	_____	+0.6 dB	

**Table 2-25. Test Record for HP 83620A and 83622A (4 of 8)**

Model		Report No.			Date
Test No.	Test Description	Minimum Spec.	Results	Maximum Spec.	Measurement Uncertainty
6.	Maximum Leveled Power				
	10. Standard	+10 dBm	_____		
	with Option 001	+8.5 dBm	_____		
	Option 006	+13 dBm	_____		
	with Option 001	+11.5 dBm	_____		
7.	External Leveling				
	7. Minimum Power		_____	-0.2 mV	
	9. Maximum Power	-0.5 V	_____		
8.	Spurious Signals: Harmonic				
	7. Harmonics				
	<1.8 GHz:				
	Standard	-35 dBc	_____		
	Option 006	-25 dBc	_____		
	≥1.8 and ≤20 GHz:				
	Standard	-50 dBc	_____		
	Option 006	-20 dBc	_____		
	7. Subharmonics				
	≥7 and ≤20 GHz	-50 dBc	_____		
9.	Spurious Signals: Non-harmonic				
	10. Spur Frequency:				
	_____	-60 dBc	_____		
	_____	-60 dBc	_____		
	_____	-60 dBc	_____		
	_____	-60 dBc	_____		
	125 kHz	-60 dBc	_____		
	500 kHz	-60 dBc	_____		

**Table 2-25. Test Record for HP 83620A and 83622A (5 of 8)**

Model		Report No.			Date
Test No.	Test Description	Minimum Spec.	Results	Maximum Spec.	Measurement Uncertainty
15.	Spur Frequency:				
	100 MHz Fixed	-60 dBc	_____		
	100 MHz Offset	-60 dBc	_____		
	LO Feedthrough	-60 dBc	_____		
10.	Spurious Signals: Line Related				
	10. 120 Hz	-55 dBc	_____		
	10. 180 Hz	-55 dBc	_____		
	10. 240 Hz	-55 dBc	_____		
11.	Single Sideband Phase Noise				
	7. Offsets at 6.99 GHz:				
	100 Hz to <1 kHz	-70 dBc	_____		
	1 kHz to <10 kHz	-78 dBc	_____		
	10 kHz to <100 kHz	-86 dBc	_____		
	≥100 kHz	-107 dBc	_____		
	Offsets at 2.23 GHz:				
	100 Hz to <1 kHz	-70 dBc	_____		
	1 kHz to <10 kHz	-78 dBc	_____		
	10 kHz to <100 kHz	-86 dBc	_____		
	≥100 kHz	-107 dBc	_____		
	Offsets at 18.0 GHz:				
	100 Hz to <1 kHz	-60 dBc	_____		
1 kHz to <10 kHz	-68 dBc	_____			
10 kHz to <100 kHz	-76 dBc	_____			
≥100 kHz	-97 dBc	_____			

Table 2-25. Test Record for HP 83620A and 83622A (6 of 8)

Model		Report No.			Date
Test No.	Test Description	Minimum Spec.	Results	Maximum Spec.	Measurement Uncertainty
12.	Pulse Modulation On/Off Ratio				
	12. On/Off Ratio	80 dB	_____		
13.	Pulse Performance				
	11. Rise Time:				
	Standard		_____	50 ns	
	Option 006		_____	10 ns	
	11. Fall Time:				
	Standard		_____	50 ns	
	Option 006		_____	10 ns	
	23. Level Accuracy		_____	±0.3 dB	
14.	Pulse Modulation Video Feedthrough				
	20. <2.3 GHz at ≤10 dBm		_____	2%	
	22b. <2.3 GHz at >10 dBm		_____	5%	
	27. ≥2.3 <sup>1</sup> and ≤20.0 GHz:				
	Standard		_____	2 mV	
	Option 006		_____	20 mV	
15.	AM Accuracy				
	10. Maximum Difference	95%	_____	105%	
	13. AM Depth	25%	_____	35%	
16.	AM Bandwidth				
	10. Maximum Difference p-p		_____	3 dB	

Table 2-25. Test Record for HP 83620A and 83622A (7 of 8)

Model		Report No.			Date
Test No.	Test Description	Minimum Spec.	Results	Maximum Spec.	Measurement Uncertainty
17.	AM Dynamic Range				
	12. Normal		_____	-20 dBm	
	19. Normal Internal		_____	-20 dBm	
	30. Deep		_____	-50 dBm	
	37. Deep Internal		_____	-50 dBm	
18.	FM Accuracy				
	13. Maximum FM Error	-10%	_____	+10%	
	23. Maximum FM Error	-10%	_____	+10%	
19.	FM Bandwidth				
	17. Maximum Difference p-p		_____	6 dB	
20.	Maximum FM Deviation				
	12. DC FM Unlocked $\leq 100$ Hz: $> \pm 75$ MHz Deviation		Pass/Fail		
	22. FM Deviation	$\pm 75$ MHz	_____		
	34. AC FM Locked 100 kHz: Modulation Index $\geq 5$				
	1 GHz	500 kHz	_____		
	5 GHz	500 kHz	_____		
	9 GHz	1 MHz	_____		
	17 GHz	1.5 MHz	_____		
	34. AC FM Locked 1 MHz: Modulation Index $\geq 5$				
	1 GHz	5 MHz	_____		
	5 GHz	5 MHz	_____		

Table 2-25. Test Record for HP 83620A and 83622A (8 of 8)

Model		Report No.			Date
Test No.	Test Description	Minimum Spec.	Results	Maximum Spec.	Measurement Uncertainty
	34. AC FM Locked 3 MHz: >±8 MHz deviation				
	1 GHz	8 MHz	_____		
	5 GHz	8 MHz	_____		
	40. Internal AC FM Locked 100 kHz: Modulation Index ≥ 5				
	1 GHz	500 kHz	_____		
	5 GHz	500 kHz	_____		
	9 GHz	1 MHz	_____		
	17 GHz	1.5 MHz	_____		
	40. Internal AC FM Locked 1 MHz: Modulation Index ≥ 5				
	1 GHz	5 MHz	_____		
5 GHz	5 MHz	_____			
21. Internal Pulse Accuracy (Opt. 002)					
4. Pulse Width	20 ns	_____		30 ns	
6. Pulse Width	45 ns	_____		55 ns	
22. Modulation Meter (Opt. 002)					
4. AM Meter	25%	_____		35%	
6. AM Meter	25%	_____		35%	
10. FM Meter	4.95 MHz	_____		5.05 MHz	
12. FM Meter	950 kHz	_____		1.05 MHz	

**Operation Verification**



# HP 8360 Series Operation Verification

---

## INTRODUCTION

The following procedures meet the needs of most incoming inspections (80% verification), and provide a reasonable assurance that the instrument is functioning properly. Do the procedures in the order given.

## MENUS

If you are not familiar with the menus in this instrument, go to the "MENUS" chapter and fold out the menu maps.

Some menus have more than one page of softkeys. Select the **[More]** softkey to view the next page of softkeys. **[More]** is *not* included in the keystrokes given in these procedures.

## THE OPERATION VERIFICATION FORM

Operation verification forms are supplied at the end of this chapter. Use the forms to record the pass/fail results of an operation verification. There may be more than one form provided. Be sure to use the one designated (at the top) for your synthesizer.

### 1. SELF-TESTS

1. Perform the full self-tests contained in the instrument firmware. No additional test equipment is required. With no connections to the synthesizer, set:

**SERVICE** **[Selftest (Full)]**

The synthesizer executes a series of self-tests. When completed, the following message is displayed if all the tests passed:

**ALL SELF-TESTS HAVE PASSED!**

2. Record *Pass* on the operation verification form and continue to the next test, "Power Accuracy".

If the synthesizer fails one or more self-tests, a different message is displayed listing the most independent test that failed and a reference to the best entry point into the "TROUBLESHOOTING" chapter of the *Assembly-Level Repair* manual. Record *Fail* on the operation verification form and see the *Assembly-Level Repair* manual for troubleshooting information. After repair, repeat operation verification from the beginning.

## **2. POWER ACCURACY**

1. Follow the procedure given in "PERFORMANCE TESTS" in this manual.
2. If the synthesizer passes this test, record *Pass* on the operation verification form and continue to the next test, "Maximum Leveled Power".

If the synthesizer fails, record *Fail* on the operation verification form and then follow the "In Case of Difficulty" instructions given for this performance test. After repair, repeat operation verification from the beginning.

## **3. POWER FLATNESS**

1. Follow the procedure given in "PERFORMANCE TESTS" in this manual.
2. If the synthesizer passes this test, record *Pass* on the operation verification form and continue to the next test, "Power Accuracy."

If the synthesizer fails, record *Fail* on the operation verification form and then follow the "In Case of Difficulty" instructions given for this performance test. After repair, repeat operation verification from the beginning.

## **4. MAXIMUM LEVELED POWER**

1. Follow the procedure given in "PERFORMANCE TESTS" in this manual.
2. If the synthesizer passes this test, record *Pass* on the operation verification form. Operation verification is completed.

If the synthesizer fails, record *Fail* on the operation verification form and then follow the "In Case of Difficulty" instructions given for this performance test. After repair, repeat operation verification from the beginning.

**Table 2-25. Operation Verification form for the HP 83620A and 83622A**

Test Facility _____	Date _____
Model _____	Customer _____
Serial Number _____	Tested By _____
Options _____	Firmware Revision _____
<b>Test</b>	<b>Results (Pass/Fail)</b>
1. Self-Tests	_____
2. Power Accuracy	_____
3. Power Flatness	_____
4. Maximum Leveled Power	_____

### **3 ADJUSTMENTS**

## 3. HP 8360 Series Adjustments

---

### HOW TO USE THIS CHAPTER

Perform these adjustments only if directed by the "TROUBLESHOOTING" chapter of the *Assembly-Level Repair* manual or if a performance test fails.

#### Menus

If you are not familiar with the menus in the synthesizer, fold out the menu maps in the "MENUS" chapter (see the following figure).

Some menus have more than one page of softkeys. Select the **[More]** softkey to view the next page of softkeys. **[More]** is *not* included in the keystrokes given in these procedures.

#### Note



In all cases where you are instructed to preset the synthesizer, use the factory preset mode only.

If a password is set, it will have to be disabled before the adjustment menu can be accessed. See "Calibration Constants" in this manual for instructions.

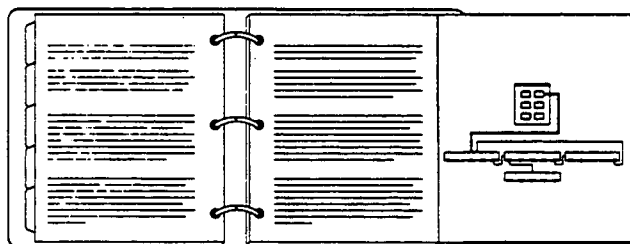

## EQUIPMENT REQUIRED

The equipment required to perform the adjustments in this chapter is listed in the "EQUIPMENT REQUIRED" chapter of this manual. You may use any equipment that satisfies the critical specifications given. Use a *non-metallic* adjustment tool.

## CAUTIONS AND WARNINGS

Although this instrument has been designed in accordance with international safety standards, for safe operation you must follow the cautions and warnings in this manual.

### Warning



**Voltages in the instrument can cause personal injury; be extremely careful. Capacitors can be charged even if the instrument has been disconnected from line power.**

*Table 3-1. Adjustments*

Adjustment	Page
1. 10 MHz Standard	3-3
2. Fractional-N VCO	3-7
3. Fractional-N Reference and API Spurs	3-9
4. Sweep Ramp	3-13
5. Sampler Assembly	3-15
6. YO Driver +10V Reference	3-21
7. YO Driver Gain and Linearity	3-23
8. YO Loop Gain	3-25
9. Amplifier Detector Offset	3-27
10a. SYTM Adjustments	3-29
10b. SYTM Adjustments Option 006	3-53
11. Low Power SRD Bias	3-77
12. Amplifier Detector Gain	3-81
13. Modulator Offset and Gain	3-83
14. ALC Power Level Accuracy	3-87
15. Power Flatness	3-91
16. Modulation Generator	3-93
17. AM Accuracy	3-95
18. AM Delay	3-99
19. Pulse Delay	3-101
20. FM Gain	3-105
21. Square Wave Symmetry	3-109
22. AM Input Impedance	3-111
23. FM Input Impedance	3-113
24. Modulation Generator Flatness	3-115

For the following adjustments, see "AUTOMATED TESTS":

- YO Delay Adjustment.
- Step Attenuator Flatness Adjustment.
- ADC Adjustment.
- Power Flatness.

## 1. 10 MHZ STANDARD

### Description and Procedure

This procedure adjusts the frequency accuracy of the internal 10 MHz time base. This adjustment should be done on a regular basis if absolute frequency accuracy is important (see figure 3-3.)

For best accuracy, readjust the 10 MHz timebase oscillator after the synthesizer has been on or in standby for 24 hours. See "Accuracy Versus Adjustment Interval," following this adjustment, for information on how to determine a periodic adjustment schedule.

After the timebase is adjusted, the timebase frequency should stay within the aging rate if the following things happen:

- The time base oven does not cool down.
- The instrument keeps the same orientation with respect to the earth's magnetic field.
- The instrument stays at the same altitude.
- The instrument does not receive any mechanical shock.

If the time base oven cools (the instrument is disconnected from ac power), you may have to readjust the time base frequency after a new warmup cycle. Typically, however, the time base frequency returns to within  $\pm 1$  Hz of the original frequency.

### Note



You can adjust the internal timebase after reconnecting ac power for 10 minutes, but for best accuracy, test again after the instrument has been on or in standby for 24 hours.

Frequency changes, due either to a change in orientation with respect to the earth's magnetic field or to a change in altitude, are usually eliminated when the instrument is returned to its original position. A frequency change due to mechanical shock usually appears as a fixed frequency error.

1. Connect the equipment as shown in figure 3-1. Preset all instruments and let them warm up for one hour.

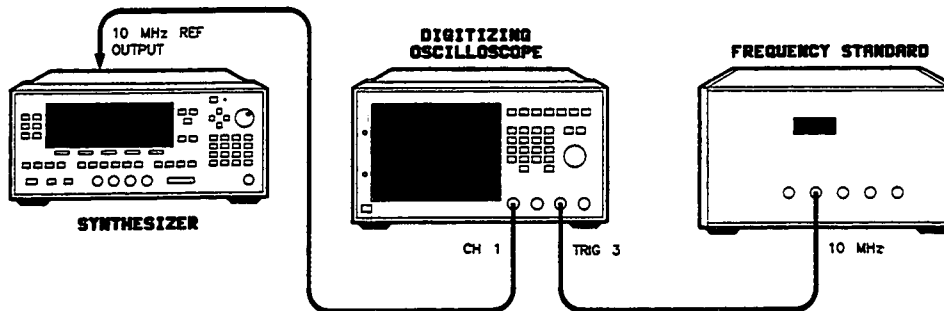

**Note**



If the oscilloscope does not have a 50Ω input impedance, connect channel 1 through a 50Ω feedthrough.

*Figure 3-1. 10 MHz Standard Adjustment Setup*

2. On the oscilloscope, set:

Channel 1:

Display	On
Volts/Division	200 mV
Input Coupling	dc
Input Impedance	50Ω

Channel 2:

Display	Off
---------	-----

Timebase:

Time/Division	10 ns
Trigger	External

Trigger:

Trigger Mode	Edge
Trigger Source	Trig 3
Input Coupling	ac

Display:

Display Mode	Real Time
--------------	-----------

3. On the oscilloscope, adjust the trigger level so that the sweep is synchronized to the synthesizer's internal standard. The waveform will appear to drift.
4. Using a non-metallic tool, adjust the A23 10 MHz standard (see figure 3-2) for minimum horizontal movement of the oscilloscope waveform.



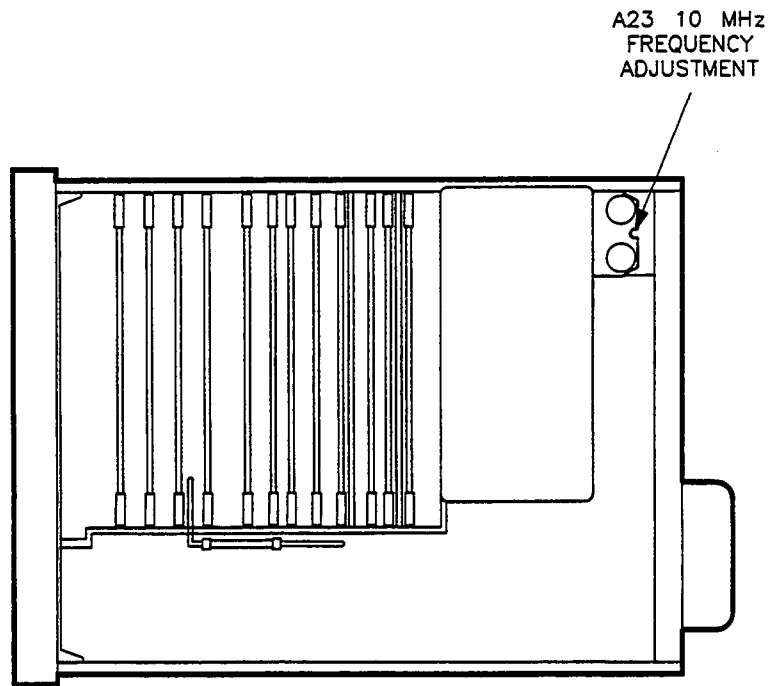

Figure 3-2. 10 MHz Standard Adjustment Location

### Related Performance Tests

Internal Timebase: Aging Rate

### In Case of Difficulty

1. Ensure that an external standard is not connected. (At instrument preset the synthesizer automatically chooses the external standard as the reference if one is connected to the 10 MHz REF INPUT.)
2. See "TROUBLESHOOTING" in the *Assembly-Level Repair* manual.

### ACCURACY VERSUS ADJUSTMENT INTERVAL

Figure 3-3 shows the required adjustment interval to maintain a given accuracy. If you know the aging rate, you can determine a more precise adjustment interval.

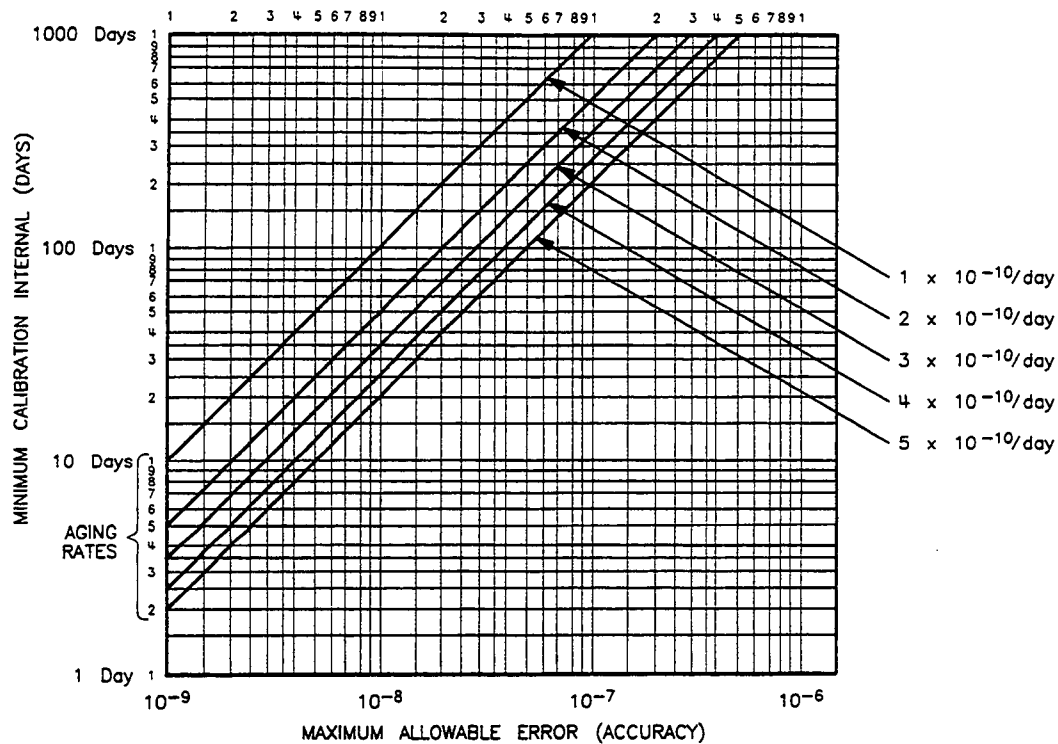

Figure 3-3. Accuracy Versus Adjustment Interval

1. Find the line on figure 3-3 that corresponds to the 10 MHz timebase oscillator aging rate (to determine the aging rate, see "Performance Tests").
2. On the horizontal axis, find the maximum allowable error (accuracy) that you want.
3. Follow the maximum allowable error vertically until it intersects the known aging rate.
4. From the point of intersection, move horizontally to the left and read the minimum calibration interval measured in days.

### An Alternate Method

You can also determine the minimum calibration interval using the following formula:

$$\frac{\text{maximum allowable error}}{\text{known aging rate (per day)}} = \text{calibration interval in days}$$

## 2. FRACTIONAL-N VCO

### Description and Procedure

No test equipment is required for this procedure.

This adjustment sets the VCO tuning voltage to  $-6.0V$  for a VCO output of 60 MHz.

1. Leaving all cables connected, place the A4 fractional-N assembly on an analog extender board.
2. Turn the synthesizer on and press **PRESET**. Let the instrument warm up for at least one hour.
3. Select the A4 VCO tune adjustment. On the synthesizer, set:  
**SERVICE** **[Adjust Menu]** **[AssyAdj Menu]** **[A4 VCO Tune]**
4. Using a non-metallic tool, adjust A4L1 (see figure 3-4) to center the needle on the display.

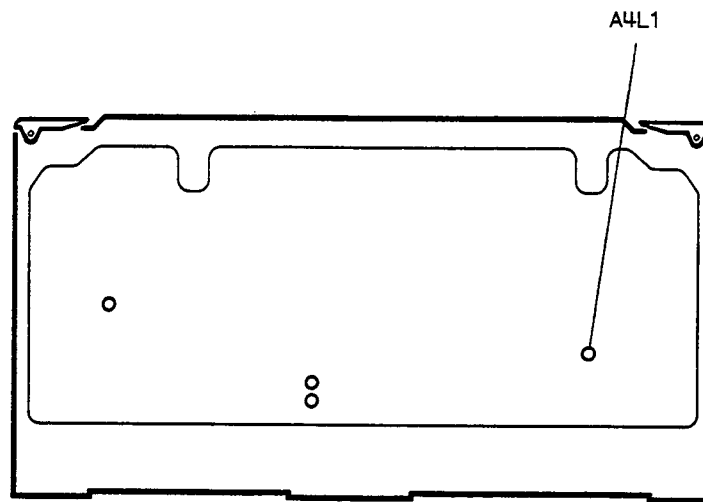

Figure 3-4. A4L1 Location

5. Turn the synthesizer to standby, and reinstall the A4 assembly.

## **Related Performance Tests**

Self-tests

Frequency Switching Time

Single Sideband Phase Noise

## **In Case of Difficulty**

1. Verify that an analog extender board is used.
2. Make sure the 125 kHz reference cable, W11, is connected to A4J1.
3. For synthesizers with option 003, use the "Front Panel Emulation Software" described in the "AUTOMATED TESTS" chapter of this manual or use a substitute front panel.
4. See "TROUBLESHOOTING" in the *Assembly-Level Repair* manual.

### 3. FRACTIONAL-N REFERENCE AND API SPURS

#### Note



Do *not* perform this adjustment on a new or rebuilt replacement assembly. The A4 assembly is factory-adjusted, and is *not* instrument dependent.

#### Description and Procedure

This adjustment minimizes three known spurs (125 kHz reference, API 1, and API 2). At each spur frequency, the spectrum analyzer is phase locked to the synthesizer, connected directly to the A4 fractional-N assembly output, and operated in zero span. A4R70, R31, and R30 are adjusted for minimum spur level. Table 3-2 summarizes this adjustment.

Table 3-2. Summary of Fractional-N Reference & API Spurs Adjustment

Spur	Fractional-N CW Frequency (MHz)	Analyzer Frequency (MHz)	Potentiometer	Minimum dBc
125 kHz Reference	44.125	44.0	A4R70	-75
API 1	44.005	44.0	A4R31	-70
API 2	44.0005	44.0055	A4R30	-80

1. With the A4 assembly on an analog extender board, connect the equipment as shown in figure 3-5. Preset the instruments, and let them warm up for at least one hour.

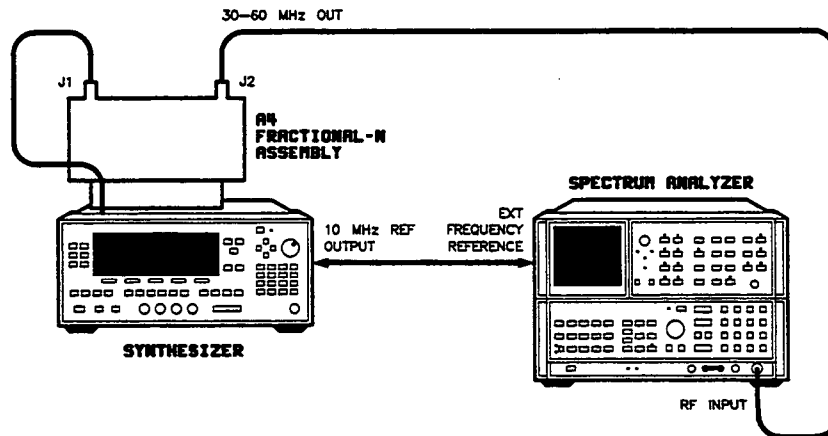

Figure 3-5. Fractional-N Reference and API Spur Adjustment Setup

2. On the spectrum analyzer, set:

Frequency Span: 0 Hz  
Resolution Bandwidth: 10 Hz  
Sweep Time: 10 s  
Reference Level: -10 dBm  
Scale Log: 10 dB/Division  
Video Averaging: Off  
Clear Write A: Selected

### 125 kHz Reference Spur Adjustment

3. On the synthesizer, set:

**CW**

**SERVICE** [**Tools Menu**] [**Cnt/PLL Menu**] [**Frac N Menu**] [**CW**] **44.125** **MHz**

4. On the spectrum analyzer, set:

Center Frequency: 44.125 MHz  
Frequency Span: 500 Hz

Adjust the frequency offset to center the signal on the display.

Frequency Span: 0 Hz

Peak the signal on the display.

Note the signal level: \_\_\_\_\_ dBm

Center Frequency: 44.0 MHz  
Reference Level: -40 dBm

- On the synthesizer, adjust A4R70 (see figure 3-6) for minimum signal on the spectrum analyzer.

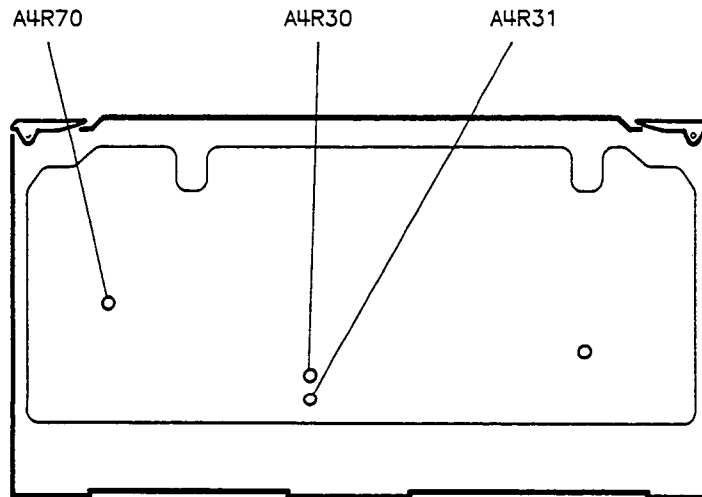

Figure 3-6. Fractional-N Reference and API Spurs Adjustment Locations

The difference in level between the signal noted in step 4 and the signal in this step should be at least  $-75$  dBc.

#### API 1 Spur Adjustment

- On the synthesizer, change the fractional-N to CW 44.005 MHz. Press:

- On the spectrum analyzer, set:

Center Frequency:	44.005 MHz
Reference Level:	+10 dBm
Note the signal level:	_____ dBm
Center Frequency:	44.0 MHz
Reference Level:	-40 dBm

- On the synthesizer, adjust A4R31 (see figure 3-6) for minimum signal on the spectrum analyzer.

The difference in level between the signal noted in step 7 and the signal in this step should be at least  $-70$  dBc.

### API 2 Spur Adjustment

9. On the synthesizer, change the fractional-N to CW 44.0005 MHz. Press:

**44.0005** **MHz**

10. On the spectrum analyzer, set:

Center Frequency: 44.0005 MHz

Reference Level: +10 dBm

Note the signal level: \_\_\_\_\_ dBm

Center Frequency: 44.0055 MHz

Reference Level: -40 dBm

11. On the synthesizer, adjust A4R30 (see figure 3-6) for minimum signal on the spectrum analyzer.

The difference in level between the signal noted in step 10 and the signal in this step should be at least -80 dBc.

12. Turn the synthesizer to standby and reinstall the A4 assembly.

### Performance Tests

Spurious Signals (Non-Harmonics)

#### In Case of Difficulty

1. Ensure that the spectrum analyzer is locked to the external reference.
2. You may need to use video averaging on the spectrum analyzer if the spur level is low enough to be hidden by phase noise.
3. If you cannot adjust spurs below the recommended levels, the problem is probably with the A4 fractional-N assembly. See "TROUBLESHOOTING," in the *Assembly-Level Repair* manual.



## 4. SWEEP RAMP

### Description and Procedure

No test equipment is required for this adjustment.

This is an automatic adjustment. The synthesizer's internal DVM measures the sweep ramp voltage at the end of the sweep. The synthesizer then sets the sweep time calibration constants to calibrate the sweep ramp.

1. Turn the synthesizer on and press **PRESET**. Let the synthesizer warm up for at least one hour.
2. Select the A14 sweep ramp adjustment. On the synthesizer, set:

**SERVICE** [Adjust Menu] [AssyAdj Menu] [A14 SwpRmp]

The synthesizer will measure, calculate, and store the sweep time calibration constants. When the adjustment is complete, the following message appears on the display:

Sweep Ramp Cal Completed

Calibration constants were modified.

3. If this is the last calibration constant you will be adjusting, see "Calibration Constants" to store the calibration constants as protected data (in EEPROM).

### Related Performance Tests

Self-Tests  
Swept Frequency Accuracy

### In Case of Difficulty

See "TROUBLESHOOTING" in the *Assembly-Level Repair* manual.

## 5. SAMPLER ASSEMBLY

### Description and Procedure

No test equipment is required for this procedure.

There are four sampler assembly adjustments:

- In the 200 MHz loop VCO tune adjustment, the synthesizer uses an internal DVM to let you adjust the VCO in the 200 MHz loop.
  - In the sampler match adjustment, as the internal DVM monitors the loop input to the sampler, you adjust trim capacitors to optimize the sampler match over the full frequency range of the loop.
  - The 200 MHz loop gain adjustment is automatic. When you select this adjustment in the A6 adjustment menu, the synthesizer selects internal calibration constants for optimum loop gain over the full frequency range of the loop.
  - In the IF gain adjustment, as the internal DVM monitors the IF output level to the YO loop, you adjust the IF amplifier gain.
1. Turn the synthesizer to standby. At FL2 (see figure 3-7), disconnect the semi-rigid cable between FL2 and the A6 assembly.

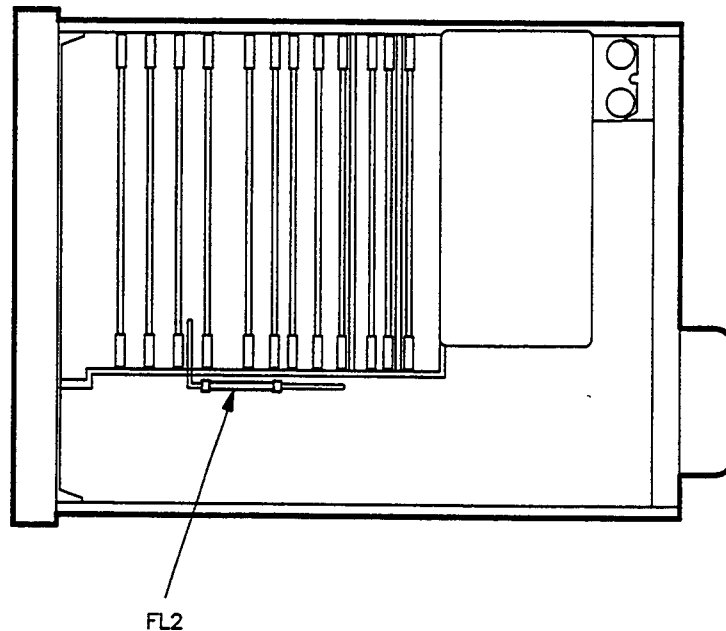

Figure 3-7. FL2 Location

2. Leaving the flexible cable connected to A6J1 (40 MHz reference), place the A6 assembly on the analog extender board.
3. Turn the synthesizer on and press **PRESET**. Let it warm up for at least one hour.
4. Select the A6 adjustment menu. Press:  
**SERVICE** **[Adjust Menu]** **[AssyAdj Menu]** **[A6 Adj Menu]**

#### 200 MHz Loop VCO Tune Adjustment

5. In the A6 adjustment menu, select the A6 VCO tune adjustment, **[A6 VCO Tune]**.
6. Adjust A6C55 (see figure 3-8) to center the "needle" on the display.

If the needle does not adjust (remains fully to the left or right), add or subtract fixed trim capacitors. See the "VCO Fixed Trim Capacitor Selection" procedure at the end of this adjustment procedure.

7. Select **[Done]**.

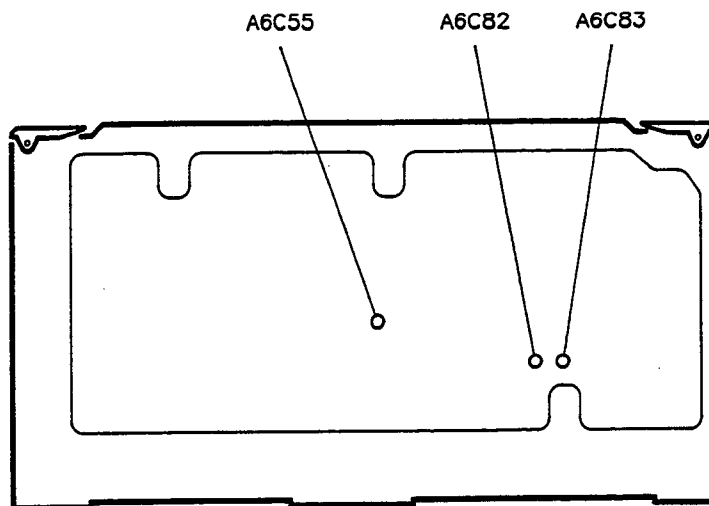

*Figure 3-8. 200 MHz Loop VCO Tune and Sampler Match Adjustment Locations*

### Sampler Match Adjustment

8. In the A6 adjustment menu, select the A6 sampler match adjustment, **[A6 Smpplr Match]**.

### Note



The sampler match display is a graphic representation of the sampler match over the full frequency range of the 200 MHz loop. The more asterisks displayed at a frequency, the more output signal (and the better the match) at that frequency. Make the adjustment for best match over the full frequency range of the loop.

9. Adjust A6C82 and A6C83 (figure 3-8) for best overall sampler match.
10. Select **[Done]**.

### 200 MHz Loop Gain Adjustment

11. In the A6 adjustment menu, select the A6 loop gain adjustment, **[A6 Loop Gain]**. The synthesizer automatically performs the adjustment. When the message **Calibration Constants should be SAVED** is displayed, the adjustment is complete. Continue with the next step.
12. Set the synthesizer to standby. Reinstall the A6 assembly in the instrument, and connect all cables.

### IF Gain Adjustment

13. Turn the synthesizer on. Select **[A6 IF Gain]**.
14. Adjust A6R73 (see figure 3-9) to center the "needle" on the display.

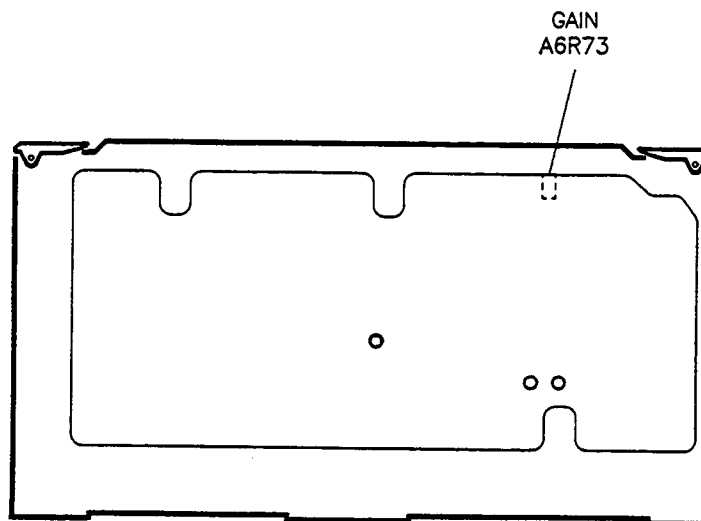

Figure 3-9. IF Gain Adjustment Location

15. Select **[Done]**.

16. If this is the last calibration constant you will be adjusting, see "Calibration Constants" to store the calibration constants as protected data (in EEPROM).

## **Related Performance Tests**

### **Self-tests**

Frequency Switching Time

Spurious Signals (Non-Harmonics)

Single Sideband Phase Noise

## **In Case of Difficulty**

1. Make sure the 40 MHz reference input cable is connected while the A6 assembly is on the analog extender board.
2. For the IF gain adjustment, if the needle registers on the far left or right, ensure that all coax cables (including semi-rigid) are connected and that no unlocked message is displayed.
3. There is some interaction between the adjustments in this procedure. Try an alternate order of adjustments.
4. See "TROUBLESHOOTING" in the *Assembly-Level Repair* manual.

## VCO FIXED TRIM CAPACITOR SELECTION

### Note



The shields on the A6 assembly affect the capacitance value. You must have the shield on to make the adjustment. Take the shield off to remove or add capacitors. Put the shield back on to determine the effect of adding or deleting capacitors.

1. If the needle is to the right of center with the A6C55 capacitor fully counterclockwise, remove capacitors, one at a time, until the needle is to the left of center. See figure 3-10 for capacitor locations.

Repeat the 200 MHz Loop VCO Tune adjustment.

2. If the needle is to the left of center with the A6C55 capacitor fully clockwise, add capacitors (HP part number 0160-5896), one at a time, until the needle is to the right of center. See figure 3-10 for capacitor locations.

Repeat the 200 MHz Loop VCO Tune adjustment.

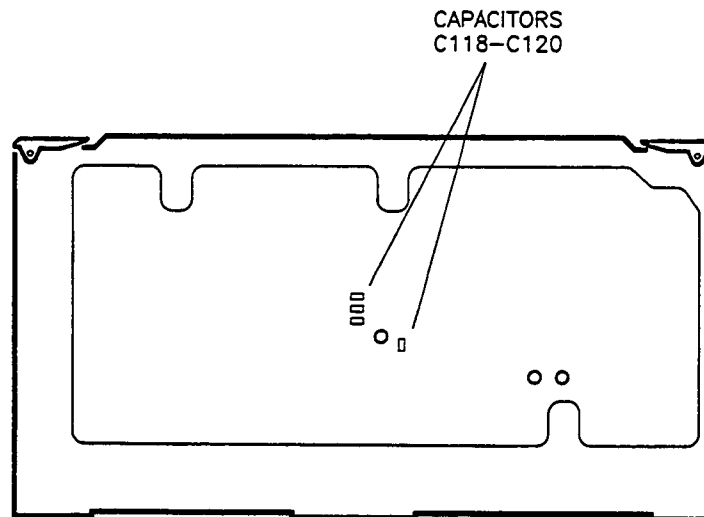

*Figure 3-10. Capacitor Locations*

## 6. YO DRIVER +10V REFERENCE

### Description and Procedure

No test equipment is required for this procedure.

As the internal DVM monitors the +10V reference, you make the adjustment.

1. Turn the synthesizer on and press **PRESET**. Let the instrument warm up for at least one hour.
2. Select the A13 adjustment menu. On the synthesizer, set:  
**SERVICE** **[Adjust Menu]** **[AssyAdj Menu]** **[A13 Adj Menu]**
3. Select the A13 +10V reference adjustment, **[A13 +10V Ref]**.
4. Adjust A13R11 (see figure 3-11) to center the "needle" on the display.

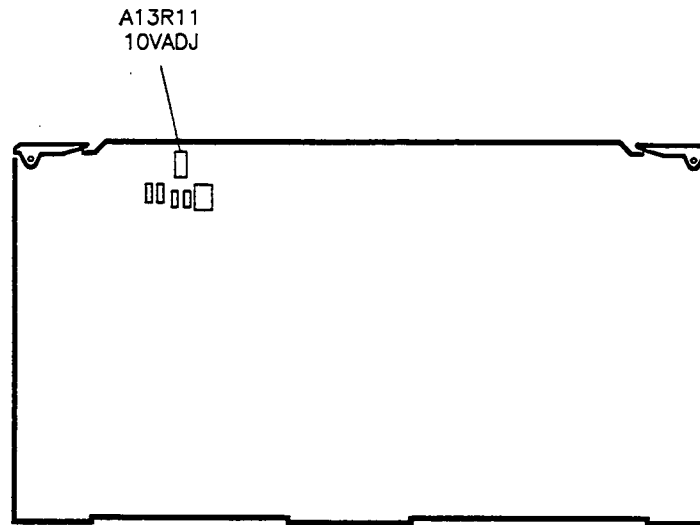

Figure 3-11. YO Driver +10V Reference Adjustment Location

5. Select **[Done]**.

### Related Performance Tests

Self-tests

### In Case of Difficulty

See "TROUBLESHOOTING" in the *Assembly-Level Repair* manual.

## 7. YO DRIVER GAIN AND LINEARITY

### Description and Procedure

No test equipment is required for these adjustments.

For the gain adjustment, the synthesizer's internal DVM monitors the YO loop error voltage at two frequencies (points B and C in 3-12). When you select the gain potentiometer adjustment, the synthesizer displays the difference in voltage between points B and C as a "needle" with arrows on either side. By adjusting A13R54 to center the "needle," you equalize the voltage between the two frequency points.

The linearity adjustment has two parts (each of which is selected and adjusted similarly to the gain adjustment). The low breakpoint adjustment equalizes the voltage between points A and B in figure 3-12. The high breakpoint adjustment equalizes the voltage between points C and D.

### Note



You must adjust the gain first, then adjust the breakpoints.

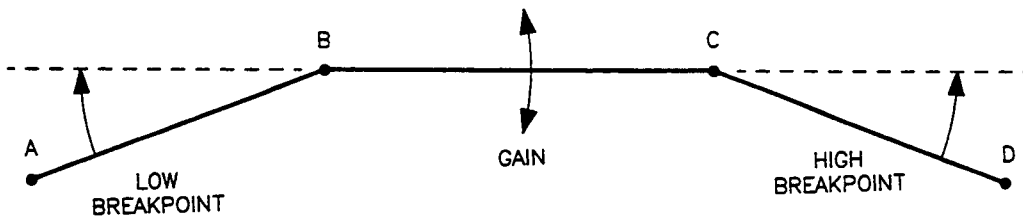

Figure 3-12. YO Gain and Linearity Breakpoints

1. Turn the synthesizer on and press **PRESET**. Let it warm up for at least one hour.
2. Select the A13 gain menu. Press:

**SERVICE** [Adjust Menu] [AssyAdj Menu] [A13 Adj Menu] [A13 Gain Menu]

### Note



If the following message is displayed: Adjust A13 pot until "locked"., adjust the potentiometer until the locked indication is displayed. Continue with step 3.



3. Select the gain potentiometer adjustment, *[Gain Pot]*.
4. Adjust A13R54 (see figure 3-13) to center the "needle" on the display.

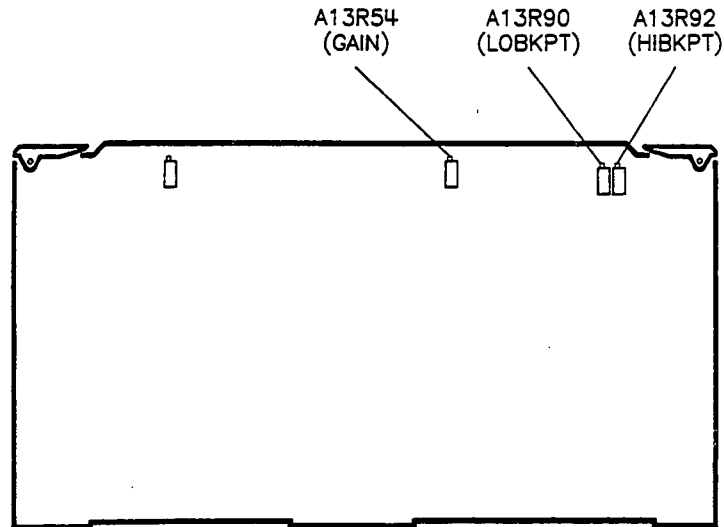

*Figure 3-13. YO Gain and Linearity Adjustment Locations*

5. Select the low breakpoint potentiometer adjustment, *[Lo Bk Pot]*.
6. Adjust A13R90 (see figure 3-13) to center the "needle" on the display.
7. Select the high breakpoint potentiometer adjustment, *[Hi Bk Pot]*.
9. Adjust A13R92 (see figure 3-13) to center the "needle" on the display.
10. Select *[Done]*.
11. If this is the last calibration constant you will be adjusting, see "Calibration Constants" to store the calibration constants as protected data (in EEPROM).

## **Related Performance Tests**

Self-tests

## **In Case of Difficulty**

See "TROUBLESHOOTING" in the *Assembly-Level Repair* manual.

## 8. YO LOOP GAIN

### Description and Procedure

No test equipment is required for this procedure.

1. Turn the synthesizer on and press **PRESET**. Let the instrument warm up for at least one hour.
2. Select the assembly adjustment menu. Press:  
**SERVICE** *[Adjust Menu] [AssyAdj Menu]*
3. Select the A5 loop gain adjustment, *[A5 Loop Gain]*.
4. On the A5 assembly, set all five switches on A5S1 to the closed position (see figure 3-14).

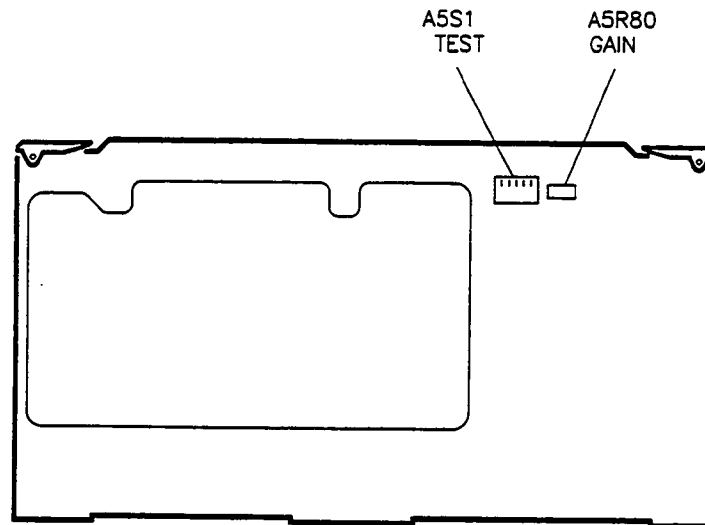

Figure 3-14. Switch and Adjustment Locations

5. Adjust A5R80 (see figure 3-14) to center the "needle" on the display.
6. Select *[Done]*.
7. Set all A5 switches to open and select *[Done]*.

## **Performance Tests**

Single Sideband Phase Noise

### **In Case of Difficulty**

1. Be sure to close the A5S1 switches before making the adjustment and open the switches when the adjustment is complete.
2. See "TROUBLESHOOTING" in the *Assembly-Level Repair* manual.

## 9. AMPLIFIER DETECTOR OFFSET

### Description and Procedure

No additional test equipment is required for this procedure.

The analog bus monitors the detector track/hold signal on the A9 pulse driver assembly with the RF power turned off. This adjustment minimizes the dc voltage at the monitoring point.

1. Turn the synthesizer on and press **(PRESET)**. Let the instrument warm up for at least one hour.
2. Select the A9 detector offset adjustment. Press:  
**(SERVICE) [Adjust Menu] [AssyAdj Menu] [A9 DetOfs]**
3. Adjust A9R87 (see figure 3-15) to center the "needle" on the display.

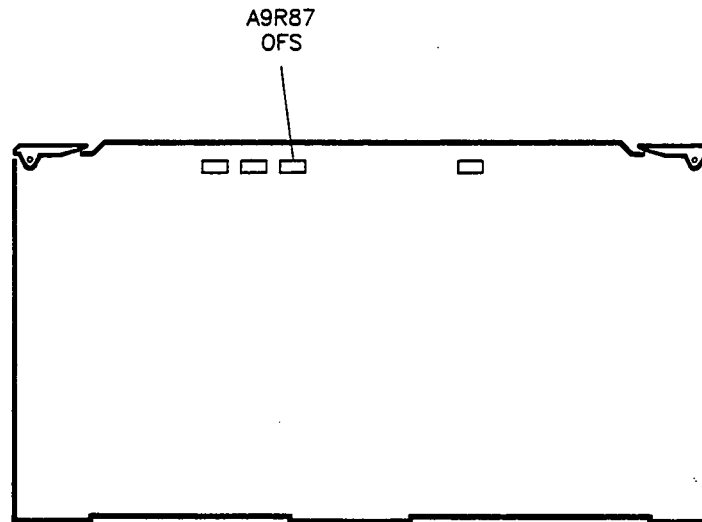

*Figure 3-15. Amplifier Detector Offset Adjustment Location*

4. Select **[Done]**.

### Related Performance Tests

Maximum Leveled Power

### In Case of Difficulty

See "TROUBLESHOOTING" in the *Assembly-Level Repair* manual.

## 10a. SYTM ADJUSTMENTS

### Note



For synthesizers with Option 006, use adjustment procedure 10b. SYTM Adjustment Option 006.

### Description and Procedure

This procedure maximizes RF power by tracking the tuned filter in the SYTM to the RF output frequency. Initial tracking is done in single band sweeps at slow sweep speeds to eliminate the effects of bandcross and hysteresis in the tuning coil. (Those will be corrected with delay and risetime calibration constants.) A squegging clamp adjustment limits the power into the SYTM and is adjusted for maximum output power without squegging. The SRD bias adjustments are made to optimize the efficiency of the frequency multiplication. Auto tracking is initiated to optimize the slow sweep tracking.

The YTM delay compensation adjustments maximize power for fast single- and multi-band sweeps. The YTM risetime adjustments are done in multi-band fast sweeps to optimize power at the start of each frequency band.

### Note



If you have replaced either the YO, the YO driver, or the SYTM driver, first initiate an auto tracking procedure. Terminate the RF OUTPUT with a good 50 $\Omega$  impedance match such as a 10 dB attenuator or a power sensor (not necessary for synthesizers with a step attenuator). Press **USER CAL** [*Tracking Menu*] [*Auto Track*]. If auto tracking passes and the instrument passes the "Maximum Leveled Power" performance test, do not continue with this procedure. If auto tracking fails, (an error message is displayed), continue with this procedure.

## Adjustment Help

The following explanations are provided for a better understanding of the SYTM adjustments. Refer to these explanations as often as necessary. They will help make these adjustments easier. (The adjustment procedure begins on page 3-35.)

### Changing Calibration Constant Values

- When setting most calibration constants, use the left and right arrow keys. They decrement and increment the values in steps of 1. This helps you to keep track of the adjustment range while monitoring the trace on the display.

For offset and gain adjustments, the adjustment range is often so large it is easier to use the rotary knob to set the calibration constants.

### Setting the Fastest Sweep Time

- Setting the sweep time to 0 milliseconds sets the synthesizer to the fastest sweep time for the frequency range being swept. Each time the frequency range is changed, the sweep time must be reset to 0 msec in order to maintain the fastest sweep time.

### Offset and Gain Adjustments

- For all offset and gain adjustments, adjust *through* the bandpass: Keep adjusting until the power peaks and then drops off. Then reset the adjustment to the peaked point.
- For all offset and gain adjustments, if power stays peaked over several calibration constant values, set the calibration constant to the middle value of the peaked range.

### Squegg Clamp Calibration Constants

The squegg clamp calibration constants are adjusted to decrease the clamp on the SYTM as far as possible to achieve the greatest power without squegging.

- When increasing any squegg clamp calibration constant, power is increased too far when any of the following occurs:
  - Any portion of the trace is distorted or power drops out in a portion of the trace (sphere squegging).
  - Power drops over a broad frequency range (diode squegging).
  - Power stops increasing on any portion of the trace.
- Diode squegging is the primary form of squegging in band 2.
- Sphere squegging is the only form of squegging in band 1.
- After increasing power to the peak, decrease power by 1.5 to 2 dB across the entire band. Power should decrease uniformly across the entire band.

### Adjusting for a Dip

- When adjusting for a dip at the high end of the band, adjust until the power peaks, then dips (reaches minimum power). Dips may be smaller than 1/3 division ( $\cong 0.5$  dB.) Note the calibration constant where this occurs. Continue adjusting in the same direction until the power peaks again. Return the adjustment to the power level of the dip.
- The passband of the SYTM varies with frequency. The SYTM adjustments set the input frequency to the SYTM to the center of the passband. Adjusting for the dip at higher frequencies actually adjusts for the dip which occurs in the center of the passbands of those frequencies (see figure 3-16).

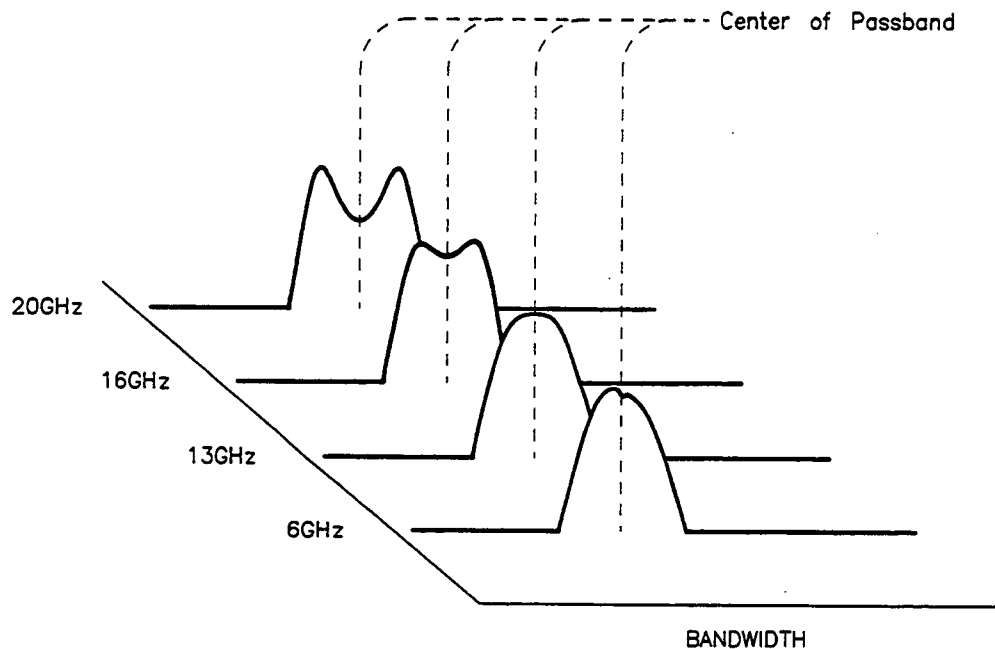

Figure 3-16. SYTM Passband Versus Frequency

### **SRD Bias Adjustment**

- When adjusting the SRD bias, decrease power by 1.3 division ( $\cong 0.5$  dB) after reaching peak power.

### **Single Band Delay Compensation Adjustments**

- If a drop in power greater than 1 division occurs when in single sweep, increase the A delay term to put the A term at the high end of the peak. For example, for the following calibration constant values:

Start of the peak = 1800  
Middle of the peak = 1950  
End of the peak = 2100

Set the A term to 2050

See figure 3-17a for a graphic representation of the frequencies affected by the calibration constants.

### **Sweep Speed Related Adjustments**

- Delay compensation and risetime adjustments are affected by sweep speed. The adjustments are performed at fast sweep speeds which are the worst case. All other adjustments are performed at slow sweep speeds; they are not affected by sweep speed.

If you have a sweep speed problem, it is probably affected by delay compensation or risetime adjustments.

### **YTM Bandcross Delay Terms**

The YTM Bx Dly terms are either offset or gain terms. A1 denotes the offset term for band 1. B1 denotes the gain term for band 1. The offset (A) should be adjusted to maximize power at the beginning of the band. The gain (B) is adjusted to maximize power toward the end of the band.

See figure 3-17 for a graphic representation of the frequencies affected by the calibration constants.



### **YTM RiseTime Compensation**

YTM Risetime compensation minimizes power dropouts that occur at the start of a band. These calibration constants will only help if the dropout does not occur during slow sweep speeds (>500 msec). When adjusting, set the risetime calibration constant to 1, then increment until the power dropout is removed (the smaller the number, the better).

Band 2 has three risetime calibration constants:

YTM Rise; Band 2 A1  
YTM Rise; Band 2 B1  
YTM Rise; Band 2 A2

Band 3 has five risetime calibration constants:

YTM Rise; Band 3 A1  
YTM Rise; Band 3 B1  
YTM Rise; Band 3 A2  
YTM Rise; Band 3 B2  
YTM Rise; Band 3 A3

*A1* indicates that the start of sweep is in the lower half of band 1. *B1* indicates that the start of sweep is in the upper half of band 1. *A2* indicates that the start of sweep is in the lower half of band 2. *B2* indicates that the start of sweep is in the upper half of band 2.

If the YTM Rise calibration constant has no effect, set it to 1.

See figure 3-17b for a graphic representation of the frequencies affected by the calibration constants.

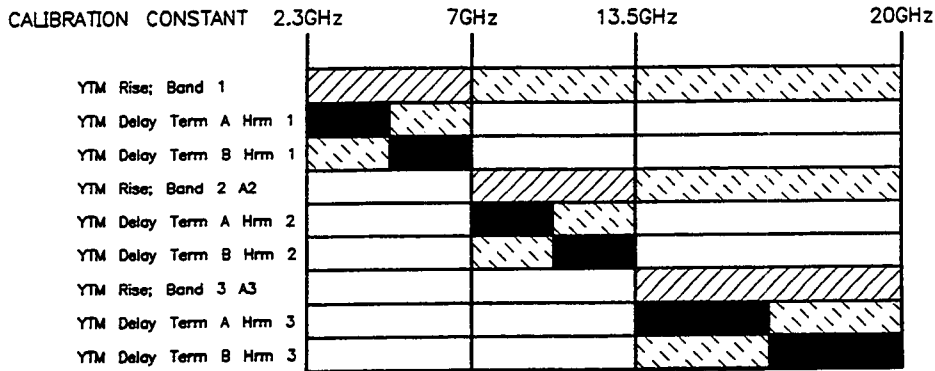
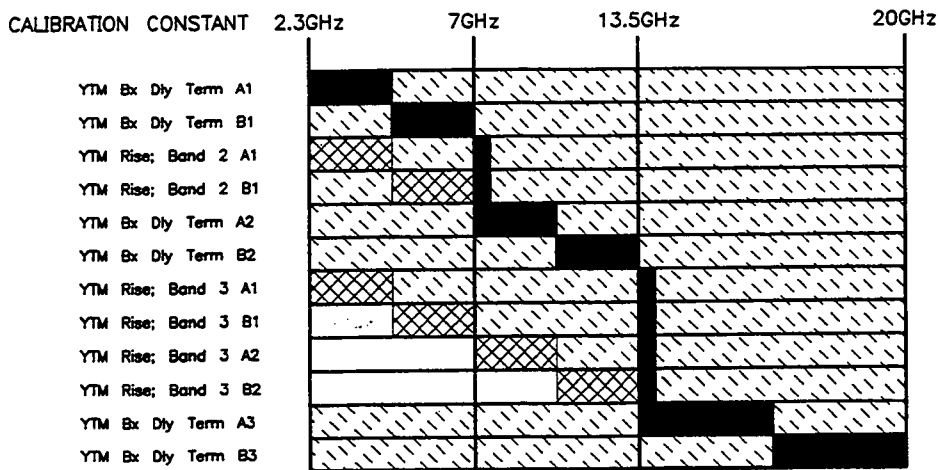

Figure 3-17a. Single-Band Delay and Risetime Compensation



- Frequencies affected by calibration constant.
- Start of sweep frequencies that enable calibration constants.
- Risetime affects start of sweep when sweep starts in this frequency range.
- Range of possible sweep.

EXAMPLE: YTM Rise; Band 3 B1 affects the beginning of Band 3 when the sweep starts in the second half of Band 1 and ends in Band 3.

Figure 3-17b. Multi-Band Delay and Risetime Compensation

## Procedure

1. Connect the equipment as shown in figure 3-18 using an analog oscilloscope with A versus B sweep capability. Do not connect the power meter yet. Power on all the instruments and let them warm up for at least one hour.
2. On the synthesizer, set:  
**PRESET** **USER CAL** [*Tracking Menu*] [*Peak RF Always*] (asterisk on)
3. On the power meter:  
Zero and calibrate the power meter/sensor.  
Set the power meter to dBm mode.

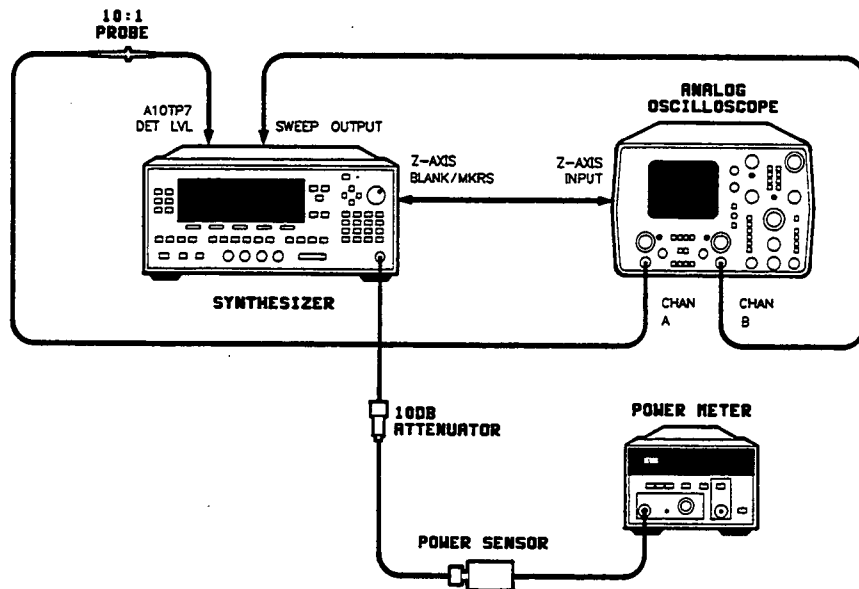

Figure 3-18. SYTM Adjustments Setup

4. Set the default values given in table 3-3 into the corresponding YTM calibration constants. On the synthesizer, set:

**SERVICE** [Adjust Menu] [Calib Menu]

**Select Cal** Enter the number of the first calibration constant from table 3-3 and terminate the entry with **ENTER**.

**[Modify Cal]** Enter the default value from table 3-3 and terminate the entry with **ENTER**.

Using the up/down arrow keys, select each of the rest of the calibration constants in table 3-3 and set their default values by entering the value on the numeric keypad. Terminate your entry with the **ENTER** key.

**Table 3-3. YTM Calibration Constants and Default Values (1 of 3)**

Number	Description	Default Value	Adjustment Description
105 106 107 108 109 110 111	SRD Bias A; Band 1 SRD Bias A; Band 2 SRD Bias A; Band 3 SRD Bias A; Band 4 SRD Bias A; Band 5 SRD Bias A; Band 6 SRD Bias A; Band 7	50 80 80 80 80 80 80	Maximize power over lower 30% of band. Sweep speed is not a factor. Adjust for 0.5 dB below maximum power.
118 119 120 121 122 123 124	SRD Bias B; Band 1 SRD Bias B; Band 2 SRD Bias B; Band 3 SRD Bias B; Band 4 SRD Bias B; Band 5 SRD Bias B; Band 6 SRD Bias B; Band 7	50 80 80 80 80 80 80	Maximize power over higher 30% of band. Sweep speed is not a factor. Adjust for 0.5 dB below maximum power.
131 132 133 134 135 136 137	Squegg Clamp 1A Squegg Clamp 2A Squegg Clamp 3A Squegg Clamp 4A Squegg Clamp 5A Squegg Clamp 6A Squegg Clamp 7A	85 125 125 125 125 125 125	Maximize power across the first half of the band without squegging. Adjusted at slow sweep speeds and single sweep mode where the SYTM sphere is most likely to squegg.
144 145 146 147 148 149 150	YTM Delay Term A Hrm 1 YTM Delay Term A Hrm 2 YTM Delay Term A Hrm 3 YTM Delay Term A Hrm 4 YTM Delay Term A Hrm 5 YTM Delay Term A Hrm 6 YTM Delay Term A Hrm 7	1600 1600 1600 1600 1600 1600 1600	Maximize power over first 20% of band. Affects fast sweeps only. Single sweep mode is also critical.

Table 3-3. YTM Calibration Constants and Default Values (2 of 3)

Number	Description	Default Value	Adjustment Description
157	YTM Delay Term B Hrm 1	300	Maximize power over higher 30% of band. Affects fast sweeps only.
158	YTM Delay Term B Hrm 2	300	
159	YTM Delay Term B Hrm 3	300	
160	YTM Delay Term B Hrm 4	300	
161	YTM Delay Term B Hrm 5	300	
162	YTM Delay Term B Hrm 6	300	
163	YTM Delay Term B Hrm 7	300	
170	YTM Bx Dly Term A1	1600	Delay compensation for multi-band sweeps only. Adjust for maximum power at lower 50% of band. Affects fast sweep speeds only.
171	YTM Bx Dly Term A2	1600	
172	YTM Bx Dly Term A3	1600	
173	YTM Bx Dly Term A4	1600	
174	YTM Bx Dly Term A5	1600	
175	YTM Bx Dly Term A6	1600	
176	YTM Bx Dly Term A7	1600	
183	YTM Bx Dly Term B1	300	Delay compensation for multi-band sweeps only. Adjust for maximum power at higher 30% of band. Affects fast sweep speeds only.
184	YTM Bx Dly Term B2	300	
185	YTM Bx Dly Term B3	300	
186	YTM Bx Dly Term B4	300	
187	YTM Bx Dly Term B5	300	
188	YTM Bx Dly Term B6	300	
189	YTM Bx Dly Term B7	300	
195	YTM Kick Threshold Max	110	Default values are not altered. Numbers should remain unchanged.
196	YTM CW Kick Max	9000	
197	YTM Mono Band Kick	2000	
198	YTM Stereo Band Kick	2000	
199	YTM Slew Rate	400	
200	YTM Slew Max	50	
201	YTM Slew Min	0	
202	YTM Neg Kick Wait	2	
203	YTM Fwd Kick Pct	50	
204	YTM Fwd Kick Wait	30	
205	YTM Rise; Band 1	15	Minimize power dropouts at the start of band. Adjustment is only effective at fast sweep speeds.
206	YTM Rise; Band 2 A1	25	
207	YTM Rise; Band 2 B1	2	
208	YTM Rise; Band 2 A2	15	
209	YTM Rise; Band 3 A1	70	
210	YTM Rise; Band 3 B1	7	
211	YTM Rise; Band 3 A2	70	
212	YTM Rise; Band 3 B2	7	
213	YTM Rise; Band 3 A3	15	
214	YTM Rise; Band 4	15	
215	YTM Rise; Band 5	15	
216	YTM Rise; Band 6	15	
217	YTM Rise; Band 7	15	

Table 3-3. YTM Calibration Constants and Default Values (3 of 3)

Number	Description	Default Value	Adjustment Description
225 226 227 228 229 230 231	*YTM Gain Band 1 *YTM Gain Band 2 *YTM Gain Band 3 *YTM Gain Band 4 *YTM Gain Band 5 *YTM Gain Band 6 *YTM Gain Band 7	2048 2048 2048 2048 2048 2048 2048	Maximize power over higher 10% of band. Adjust at slow sweep speeds.
238 239 240 241 242 243 244	*YTM Offset Band 1 *YTM Offset Band 2 *YTM Offset Band 3 *YTM Offset Band 4 *YTM Offset Band 5 *YTM Offset Band 6 *YTM Offset Band 7	2048 2048 2048 2048 2048 2048 2048	Maximize power over lower 10% of band. Adjust at slow sweep speeds.
248	YTM B2 Offset Offset	0	Maximize power at the start of band 2. Adjust at slow sweep speeds.
335 336 337 338 339 340 341	Squegg Clamp 1B Squegg Clamp 2B Squegg Clamp 3B Squegg Clamp 4B Squegg Clamp 5B Squegg Clamp 6B Squegg Clamp 7B	141 162 190 162 190 190 255	Maximize power across the second half of the band without squegging. Adjusted at slow sweep speeds and single sweep mode where the SYTM sphere is most likely to squegg.
373 374 375 376 377 378 379	YTM Dly Term C Hrm 1 YTM Dly Term C Hrm 2 YTM Dly Term C Hrm 3 YTM Dly Term C Hrm 4 YTM Dly Term C Hrm 5 YTM Dly Term C Hrm 6 YTM Dly Term C Hrm 7	50 30 30 0 0 0 0	
382 383 384 385 386 388	YTM Bx Dly Term C1 YTM Bx Dly Term C2 YTM Bx Dly Term C3 YTM Bx Dly Term C4 YTM Bx Dly Term C5 YTM Bx Dly Term C6	0 0 40 0 0 0	
525 526 527 528 529 530 531 532	Hibernation Time Bandcross 1 Bandcross 2 Bandcross 3 Bandcross 4 Bandcross 5 Bandcross 6 Bandcross 7	90 42 32 28 50 28 20 20	

## YTM Gain Adjustment

### Band 1 Adjustment

#### Note



If the synthesizer has a step attenuator (option 001), the 10 dB fixed attenuator can be eliminated by uncoupling the step attenuator and setting it to 10 dB (use the power menu).

5. On the synthesizer, set:

**START** **2.3** **GHz** (synthesizers with a lowest start frequency of 10 MHz)

**START** **2** **GHz** (synthesizers with a lowest start frequency of 2 GHz)

**STOP** **7** **GHz**

**SWEEP TIME** **200** **msec**

**POWER LEVEL** **25** **dBm**

Note that the synthesizer has unlevelled output power.

6. On the oscilloscope, set:

Channel A: 5 mV/Division

Offset: As required

Input Coupling: dc

Input Impedance: 1 M $\Omega$

Channel B: 1 V/Division

Offset: As required

Input Coupling: dc

Input Impedance: 1 M $\Omega$

Sweep Mode: A versus B

Adjust Channel B offset and volts/division for a trace that fills the full horizontal display.

7. Set A12R5 DROOP fully counterclockwise.
8. Set A12S1 switch 5 to OPEN.
9. Adjust A12R69 GAIN to maximize high end power (last two horizontal display divisions).
10. Modify calibration constant #238, YTM Offset; Band 1, to maximize low end power.

#### Note



If the power level of the left side of the display cannot be adjusted to the same as the right side, lower the right side with the B calibration constant. Then readjust the A term.

11. Adjust calibration constant #335, Squegg Clamp 1B, for maximum power without distortion or breakup on the right half of the display.

Adjust calibration constant #131, Squegg Clamp 1A, for approximately the same power level. Figure 3-19 shows an example of properly adjusted squegg clamp calibration constants (a) and the same adjustment showing a low end power dropout (b).

12. Repeat steps 9 through 11 until the entire band is peaked.

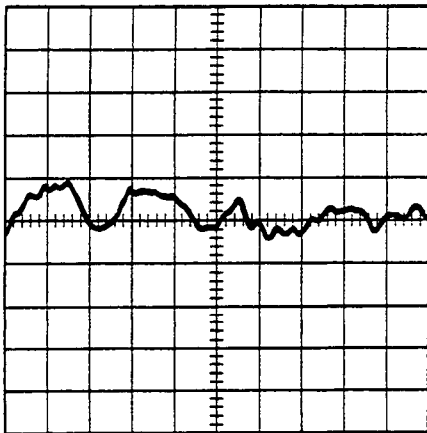

(a) No squegging

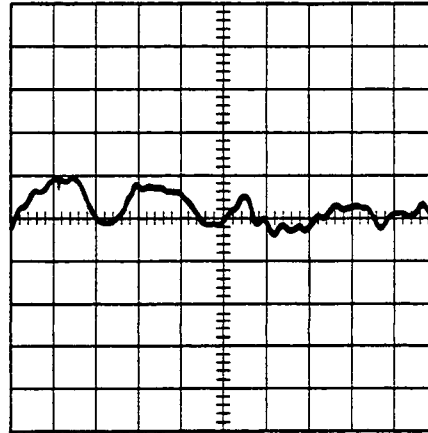

(b) Start of squegging

Figure 3-19. Squegg Clamp Band 1 Adjustment

13. Note the value of calibration constant #238, YTM Offset; Band 1 \_\_\_\_\_

Vary this calibration constant  $\pm 50$  counts and verify that the power change is uniform across the entire band. If the power change is not uniform, repeat steps 9 through 11 again.

#### Band 2 Adjustment

14. On the synthesizer, set:

START 7 GHz

STOP 13.5 GHz

CONT SWEEP TIME 200 msec



15. Set the oscilloscope vertical position as necessary to display the trace.
16. Modify calibration constant #226, YTM Gain; Band 2, to maximize high end power.
17. Modify calibration constant #239, YTM Offset; Band 2, to maximize low end power.
18. Adjust band 2 SRD bias calibration constants as follows:
  - a. Increment calibration constant #106, SRD Bias A; Band 2, to maximize low end power.
  - b. Decrement calibration constant #106, SRD Bias A; Band 2, to decrease power by  $\cong 1/3$  division (0.5 dB.)
  - c. Increment calibration constant #119, SRD Bias B; Band 2, to maximize high end power.
  - d. Decrement calibration constant #119, SRD Bias B; Band 2, to decrease power by  $\cong 1/3$  division.

### Note



If the power level of the left side of the display cannot be adjusted to the same as the right side, lower the right side with the B calibration constant. Then readjust the A term.

19. Adjust calibration constant #336, Squegg Clamp 2B, for maximum power without distortion or breakup on the right half of the display.  
Adjust calibration constant #132, Squegg Clamp 2A, for approximately the same power level.
20. Repeat steps 16 through 19 until the entire band is peaked.
21. Note the value of calibration constant #239, YTM Offset; Band 2 \_\_\_\_\_.  
Vary this calibration constant  $\pm 50$  counts and verify that the power change on the analyzer is uniform across the entire band. If not, repeat steps 14 through 20.

### Band 3 Adjustment

22. On the synthesizer, set:
  - START 13.5 GHz
  - STOP 20 GHz
  - CONT SWEEP TIME 200 msec
23. Set A12R25 B3SL1 fully clockwise.
24. Adjust calibration constant #227, YTM Gain; Band 3, for the dip at the high end (see "Adjustment Help").
25. Modify calibration constant #240, YTM Offset; Band 3, to maximize low end power.

## Note



If the power level of the left side of the display cannot be adjusted as high as required, adjust it to the highest point possible without squegging.

26. Adjust calibration constant #337, Squegg Clamp 3B, for maximum power without distortion or breakup on the right half of the display.

Adjust calibration constant # 133, Squegg Clamp 3A, for approximately the same power level. See figure 3-20 for an example of a properly adjusted trace (a) and the same trace where power has stopped increasing in the part of the low end of the band (b).

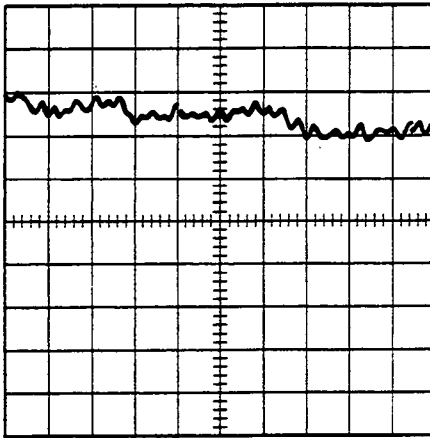

(a) Adjusted for maximum power

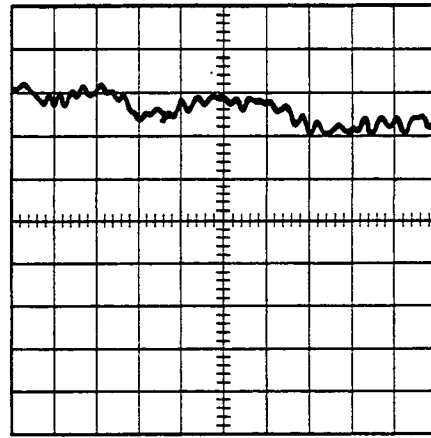

(b) No further increase in power

Figure 3-20. Squegg Clamp Band 3 Adjustment

27. Set the band 3 SRD bias calibration constants as follows:
  - a. Increment calibration constant #120, SRD Bias B; Band 3, to maximize high end power.
  - b. Decrement calibration constant #120, SRD Bias B; Band 3, to decrease power by  $\cong 1/3$  division.
  - c. Increment calibration constant #107, SRD Bias A; Band 3, to maximize low end power.
  - d. Decrement calibration constant #107, SRD Bias A; Band 3, to decrease power by  $\cong 1/3$  division.

28. Repeat steps 24 thru 27 until power is optimized over the full band. Power is optimized when the SYTM offset adjustment causes a peak in power at the start of the band coincident with a dip in power at the end of the band (see the properly adjusted trace in figure 3-20).

#### Auto Tracking Verification

29. Record the value of the following calibration constants:

#225 YTM Gain Band 1 \_\_\_\_\_  
#226 YTM Gain Band 2 \_\_\_\_\_  
#227 YTM Gain Band 3 \_\_\_\_\_  
#228 YTM Gain Band 4 \_\_\_\_\_  
#229 YTM Gain Band 5 \_\_\_\_\_  
#230 YTM Gain Band 6 \_\_\_\_\_  
#231 YTM Gain Band 7 \_\_\_\_\_  
  
#238 YTM Offset Band 1 \_\_\_\_\_  
#239 YTM Offset Band 2 \_\_\_\_\_  
#240 YTM Offset Band 3 \_\_\_\_\_  
#241 YTM Offset Band 4 \_\_\_\_\_  
#242 YTM Offset Band 5 \_\_\_\_\_  
#243 YTM Offset Band 6 \_\_\_\_\_  
#244 YTM Offset Band 7 \_\_\_\_\_

30. Initiate auto tracking on the synthesizer as follows. Terminate the RF OUTPUT with a good 50Ω impedance match such as a 10 dB attenuator or a power sensor (not necessary for synthesizers with a step attenuator.) Press:

**[USER CAL] [Tracking Menu] [Auto Track]**

Watch while the synthesizer completes auto tracking. Note if auto tracking is particularly slow in any band. If auto tracking fails (an error message is displayed) repeat the gain and offset adjustments for the failed frequency.

31. On the synthesizer, set:

**[START] [2.3] [GHz]**  
**[STOP] [13.5] [GHz]**  
**[SWEEP TIME] [500] [msec]**  
**[POWER LEVEL] [25] [dBm]**

32. Adjust calibration constant #248, YTM B2 Offset Offset, to maximize power at the start of band 2. If necessary, set a marker to 7 GHz to identify the start of band 2.

33. On the synthesizer, set:

**[START] [2.3] [GHz]**  
**[STOP] [20] [GHz]**  
**[SWEEP TIME] [1.5] [sec]**  
**[POWER LEVEL] [25] [dBm]**

34. Connect the power meter to the synthesizer's RF OUTPUT through the power sensor and 10 dB attenuator (see figure 3-18). Manually sweep the full frequency range to find the minimum power point. On the power meter, check that the power at this point is not below the specified maximum leveled power (note that power is attenuated by 10 dB). If it is, check the following:
  - a. Check the squegging clamp calibration constant for the respective band. Increase the power if needed by increasing the clamp calibration constant value on the SYTM.
  - b. Compare the manually adjusted YTM gain and YTM offset calibration constants (step 29) to the auto tracked calibration constants. A large difference in values (several hundred counts) indicates a possible misadjustment. The auto tracking values are correct. Big differences indicate where improvements in adjustment technique can be made.
35. Set the synthesizer power level to the specified maximum leveled power. Check for ALC oscillations or level squegging.
  - a. The SRD bias A or B calibration constants for the affected band might eliminate oscillation. The problem is with the A term if the oscillations are near the beginning of the band. It is with the B term if the oscillations are near the end of the band. SRD bias has a range. It can be underbiased which causes level squegging. If so, increase the value of the SRD bias calibration constants and repeat the adjustment.
  - b. If the SRD bias calibration constants have no effect, check the ALC Mod Gain calibration constant for the appropriate band.
36. Try single sweeps over various frequency ranges such as 5 GHz to 20 GHz or 10 GHz to 20 GHz. Set the sweep times to greater than 200 msec for single-band and less than 1.5 sec for multi-band sweeps since delay compensation has not yet been adjusted. Problems here are typically associated with sphere heating while awaiting the start of sweep trigger. If necessary adjust the squegging clamp calibration constant for the appropriate band.

### Tracking

37.
  - a. Note the minimum power point in the right half of the display.
  - b. Press SWEEP **MENU** [*Manual Sweep*] (asterisk on) and manually sweep the synthesizer to the minimum power point noted in step a.
  - c. Note the power meter indication. If it is  $>3.5$  dB above the specified maximum leveled power, adjust calibration constant #335, Squegg Clamp 1B, for an RF output power of 3.5 dB above the specified maximum leveled power. If it is  $<3.5$  dB above the specified maximum leveled power, do not readjust the squegg clamp.
38.
  - a. Adjust the oscilloscope vertical offset to position the trace (a dot in manual sweep) on a horizontal graticule.
  - b. Select continuous sweep.
  - c. Adjust calibration constant #131, Squegg Clamp 1A, to position the minimum power point in the left half of the display at the same horizontal graticule chosen in step 1.
  - d. If necessary, readjust calibration constant #335, Squegg Clamp 1B, to position the minimum power point on the horizontal graticule chosen in step 1.

39. On the synthesizer, set:

(START) (2.3) (GHz) (synthesizers with a lowest start frequency of 10 MHz)

(START) (2) (GHz) (synthesizers with a lowest start frequency of 2 GHz)

(STOP) (7) (GHz)

(CONT) (SWEEP TIME) (200) (msec)

a. Note the minimum power point on the oscilloscope display.

b. Press SWEEP (MENU) [*Manual Sweep*] (asterisk on) and manually sweep the synthesizer to the minimum power point from step a.

40. If the minimum power point, read from the power meter, exceeds the specified maximum leveled power level for this band *plus* 3.5 dB, decrease the value of the squegg clamp 1B calibration constant #335 until this power level is reached. Next, adjust the squegg clamp 1A calibration constant #131 until the minimum power point of the left side exceeds the specified maximum leveled power plus 3.5 dB.

41. Repeat steps 39 and 40 for the following start and stop frequencies, squegg clamp calibration constants, and power levels shown in table 3-4.

Table 3-4. Minimum Power Point Settings

Frequency (GHz)	Squegg Clamp Calibration Constant		Power Level (dB above maximum specified power)	
	1B	1A	1B	1A
7 to 13.5	336	132	3.5	3.5
13.5 to 20	337	133	6.5	3.5*

\* If power is not high enough, set the squegg clamp calibration constant to 255.

42. Disconnect the power meter/sensor from the synthesizer's RF OUTPUT.

### Single Band SYTM Delay and Risetime Compensation

43. On the synthesizer, set:

(START) (2.3) (GHz) (synthesizers with a lowest start frequency of 10 MHz)

(START) (2) (GHz) (synthesizers with a lowest start frequency of 2 GHz)

(STOP) (7) (GHz)

(CONT) (SWEEP TIME) (0) (msec)

(POWER LEVEL) (25) (dBm)

Note that the synthesizer has unleveled output power.

## Band 1 Adjustment

### Note



Since YTM Rise; Band 1 is set to the default value, a spike at the beginning of band 1 may be present.

44. Adjust calibration constant #144, YTM Dly Term A Hrm 1, to maximize power for the low end of band 1. Set the calibration constant for the middle of the peaked range.
45. Adjust calibration constant, #157 YTM Dly Term B Hrm 1, to maximize power for the high end of band 1. Set the calibration constant for the middle of the peaked range.
46. Adjust calibration constant #205, YTM Rise; Band 1, to minimize power dropout at the start of band 1.
47. Switch between the fastest sweep time and 200 msec sweep time and check that power changes less than 2/3 division ( $\cong 1$  dB.) If not, repeat steps 44 and 45.
48. On the synthesizer, set:  
**(SWEEP TIME) (0) (msec)**
49. Press **(SINGLE)** several times to initiate several sweeps. If a drop in power greater than 1 division occurs when in single sweep, increase the A term of the delay adjustment #144 to put the A term at the high end of the peak (see "Adjustment Help").

## Band 2 Adjustment

50. On the synthesizer, set:  
**(START) (7) (GHz)**  
**(STOP) (12.5) (GHz)**  
**(CONT) (SWEEP TIME) (0) (msec)**
51. Adjust calibration constant #145, YTM Dly Term A Hrm 2, to maximize power for the low end of band 2.
52. Adjust calibration constant #158, YTM Dly Term B Hrm 2, to maximize power for the high end of band 2.
53. Adjust calibration constant #208, YTM Rise; Band 2 A2, to maximize power dropout at the low end of band 2.
54. Switch between the fastest sweep time (0 msec) and 200 msec sweep time and check that power changes less than  $\cong 2/3$  division. If not, repeat steps 51 and 52.
55. On the synthesizer, set:  
**(SWEEP TIME) (0) (msec)**
56. a. Press **(SINGLE)** several times to initiate several sweeps. Note any drop in power.

- b. Press **(SINGLE)** **(RF ON/OFF)**. Then press **(RF ON/OFF)** again (LED on) and note the drop in power.
- c. The power loss noted in step a can be no smaller than the power loss noted in step b. If the step a power loss is greater than the step b power loss by 1 division ( $\cong 1.5$  dB), increase the A term of the delay adjustment #145 to put the A term at the high end of the peak (see "Adjustment Help").

### Band 3 Adjustment

57. On the synthesizer, set:

**(START)** **(13.5)** **(GHz)**  
**(STOP)** **(20)** **(GHz)**  
**(CONT)** **(SWEEP TIME)** **(0)** **(msec)**

58. Adjust calibration constant #146, YTM Dly Term A Hrm 3, to maximize power for the low end of band 3.

59. Adjust calibration constant #159, YTM Dly Term B Hrm 3, to maximize power for the high end of band 3 as follows:

- a. Offset the calibration constant enough to cause an extreme power loss in band 3.
- b. Slowly adjust the calibration constant for the dip at the high end of the band (see "Adjustment Help"). The difference between the peak and the dip may be less than 1/3 division.

60. Adjust calibration constant #213, YTM Rise; Band 3 A3, to minimize power dropout at the start of band 3.

61. Switch between the fastest sweep time (0 msec) and 200 msec sweep time and check that power changes less than 2/3 division ( $\cong 1$  dB). If necessary, repeat steps 58 and 59.

62. On the synthesizer, set:

**(SWEEP TIME)** **(0)** **(msec)**

- 63. a. Press **(SINGLE)** several times to initiate several sweeps. Note any drop in power.
- b. Press **(SINGLE)** **(RF ON/OFF)**. Then press **(RF ON/OFF)** again (LED on) and note the drop in power.
- c. The power loss noted in step a can be no smaller than the power loss noted in step b. If the step a power loss is greater than the step b power loss by 1 division ( $\cong 1.5$  dB), increase the A term of the delay adjustment #146 to put the A term at the high end of the peak (see "Adjustment Help").

### Multiband SYTM Delay and Risetime Compensation

#### Note



Power dropouts at the start of each band are typically removed with the YTM Risetime calibration constants. These will be adjusted later.

64. On the synthesizer, set:

(START) (13) (GHz)  
(STOP) (20) (GHz)  
(CONT) (SWEEP TIME) (0) (msec)  
(POWER LEVEL) (25) (dBm)

**Note**



Synthesizer markers are set to identify the bandcross frequencies (7.0 and 13.5 GHz). You can also identify bandcrosses by temporarily removing the cable from the Z-AXIS BLANK/MKRS connector on the synthesizer rear panel. Make sure this cable is connected when making adjustments.

65. On the synthesizer, set:

(MARKER) [*Marker M1*] (13.5) (GHz) (asterisk on)

66. Adjust calibration constant #172, YTM Bx Dly Term A3, to maximize power at the low end of band 3.

67. Adjust calibration constant #185, YTM Bx DLY Term B3, as follows:

- a. Offset the calibration constant enough to cause an extreme power loss in band 3.
- b. Slowly adjust the calibration constant for the dip at the high end of the band (see "Adjustment Help").

68. Switch between the fastest sweep time (0 msec) and 200 msec sweep time and check that power changes less than 2/3 division ( $\cong 1$  dB). If the change in power is greater than 2/3 division, readjust the A term of the delay adjustment #172 for low end problems, or the B term of the delay adjustment #185 for high end problems.

69. On the synthesizer, set:

(SWEEP TIME) (0) (msec)

70. Press (SINGLE) several times to initiate several sweeps. If a drop in power greater than 1 division occurs when in single sweep, increase the A term of the delay adjustment #172 to put the A term at the high end of the peak (see "Adjustment Help").

71. On the synthesizer, set:

(START) (7) (GHz)  
(CONT) (SWEEP TIME) (0) (msec)

72. Adjust calibration constant #171, YTM Bx Dly Term A2, to maximize power at the start of band 2 (start of sweep).

73. Adjust calibration constant #184, YTM Bx Dly Term B2, to maximize power at the end of band 2.

74. Adjust calibration constant #211, YTM Rise; Band 3 A2, to minimize power dropout at the start of band 3. Figure 3-21 shows the calibration constant properly adjusted (a) and misadjusted (b).



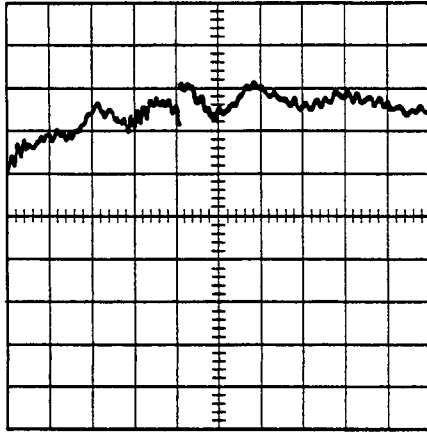

(a) Correctly adjusted

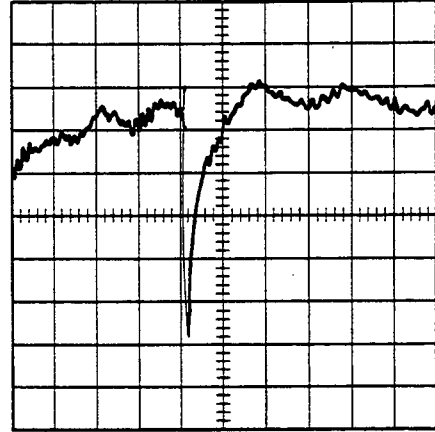

(b) Misadjusted

Figure 3-21. Band 3 A2 YTM Risetime Adjustment

75. Switch between the fastest sweep time (0 msec) and 500 msec sweep time and check that power changes less than 2/3 division ( $\cong 1$  dB) across both bands. If the change is greater than 2/3 division, readjust the appropriate delay term.
76. On the synthesizer, set:
77. Press  several times to initiate several sweeps. If a drop in power greater than 1 division occurs when in single sweep, readjust the appropriate delay term for the location of the problem.
78. On the synthesizer, set:
79. Adjust calibration constant #212, YTM Rise; Band 3 B2, to minimize power dropout at the start of band 3. Do *not* allow the value of this calibration constant to be greater than 1/5 the value of #211, YTM Rise; Band 3 A2.

80. Press **(SINGLE)** several times to initiate several sweeps. If a drop in power greater than 1/3 division occurs when in single sweep, readjust the appropriate delay or risetime term for the location of the problem.

81. On the synthesizer, set:

**(START)** **(2.3)** **(GHz)**

**(CONT)** **(SWEEP TIME)** **(0)** **(msec)**

**(MARKER)** **[Marker M2]** **(7)** **(GHz)** (asterisk on)

82. Adjust calibration constant #170, YTM Bx Dly Term A1, to maximize power at the start of band 1.

83. Adjust calibration constant #183, YTM Bx Dly Term B1, to maximize power at the high end of band 1.

84. Adjust calibration constant #209, YTM Rise; Band 3 A1, to minimize power dropout at the start of band 3.

85. Adjust calibration constant #206, YTM Rise; Band 2 A1, to minimize power dropout at the start of band 2.

86. Switch between the fastest sweep time (0 msec) and 1 sec sweep time and check that power changes less than 2/3 division ( $\cong 1$  dB) across all bands. If the change is greater than 2/3 division, readjust the appropriate delay term.

87. On the synthesizer, set:

**(SWEEP TIME)** **(0)** **(msec)**

88. Press **(SINGLE)** several times to initiate several sweeps. Note the drop in power in all bands. If a drop in power greater than 1 division occurs when in single sweep, readjust the appropriate delay or risetime term for the location of the problem.

89. On the synthesizer, set:

**(START)** **(5)** **(GHz)**

**(CONT)**

**(SWEEP TIME)** **(0)** **(msec)**

90. Adjust calibration constant #210, YTM Rise; Band 3 B1, to minimize power dropout at the start of band 3. Do *not* allow the value of this calibration constant to be greater than 1/5 the value of #209, YTM Rise; Band 3 A1.

91. Press **(SINGLE)** several times to initiate several sweeps. If a drop in power greater than 1 division occurs when in single sweep, readjust the appropriate delay or risetime term.

92. For the following start and stop frequencies:

- 0.01 to 20 GHz (synthesizers with a lowest start frequency of 10 MHz)
- 2 to 20 GHz (synthesizers with a lowest start frequency of 2 GHz)
- 4.5 to 18 GHz
- 10 to 20 GHz
- 2 to 14.5 GHz

Compare sweeps of 0 msec and 1 sec and also single sweeps at fast speed. If a power drop of 0.5 division or greater is noted, readjust the appropriate calibration constant.

93. Connect the power meter/sensor through the 10 dB attenuator to the synthesizer's RF OUTPUT.

For the frequencies listed in step 92, manually sweep the synthesizer and compare the minimum power point from the power meter to the specified maximum leveled power. The minimum power point must meet or exceed this level.

94. If this is the last calibration constant you will be adjusting, see "Calibration Constants" to store the calibration constants as protected data (in EEPROM).

## **Related Performance Tests**

Maximum Leveled Power

## **In Case Of Difficulty**

1. See "Adjustment Help" in this procedure.
2. Verify the oscilloscope ALC board calibration. When calibrated, the voltage on the oscilloscope is scaled to  $\cong 33$  mV/dB.
3. If you are unable to meet the maximum leveled power specifications, set A29R2 (amplifier detector gain adjustment) fully clockwise. Finish the SYTM adjustment. Perform the amplifier detector gain adjustment.
4. See "TROUBLESHOOTING" in the *Assembly-Level Repair* manual.

## 10b. SYTM ADJUSTMENTS OPTION 006

### Note



This adjustment procedure applies to synthesizers with Option 006.

### Description and Procedure

This procedure maximizes RF power by tracking the tuned filter in the SYTM to the RF output frequency. Initial tracking is done in single band sweeps at slow sweep speeds to eliminate the effects of bandcross and hysteresis in the tuning coil. (Those will be corrected with delay and risetime calibration constants.) A squegging clamp adjustment limits the power into the SYTM and is adjusted for maximum output power without squegging. The SRD bias adjustments are made to optimize the efficiency of the frequency multiplication. Auto tracking is initiated to optimize the slow sweep tracking.

The YTM delay compensation adjustments maximize power for fast single- and multi-band sweeps. The YTM risetime adjustments are done in multi-band fast sweeps to optimize power at the start of each frequency band.

### Note



If you have replaced either the YO, the YO driver, or the SYTM driver, first initiate an auto tracking procedure. Terminate the RF OUTPUT with a good  $50\Omega$  impedance match such as a 10 dB attenuator or a power sensor (not necessary for synthesizers with a step attenuator). Press **USER CAL** [*Tracking Menu*] [*Auto Track*]. If auto tracking passes and the instrument passes the "Maximum Leveled Power" performance test, do not continue with this procedure. If auto tracking fails, (an error message is displayed), continue with this procedure.

## Adjustment Help

The following explanations are provided for a better understanding of the SYTM adjustments. Refer to these explanations as often as necessary. They will help make these adjustments easier. (The adjustment procedure begins on page 59.)

### Changing Calibration Constant Values

- When setting most calibration constants, use the left and right arrow keys. They decrement and increment the values in steps of 1. This helps you to keep track of the adjustment range while monitoring the trace on the display.

For offset and gain adjustments, the adjustment range is often so large it is easier to use the rotary knob to set the calibration constants.

### Setting the Fastest Sweep Time

- Setting the sweep time to 0 milliseconds sets the synthesizer to the fastest sweep time for the frequency range being swept. Each time the frequency range is changed, the sweep time must be reset to 0 msec in order to maintain the fastest sweep time.

### Offset and Gain Adjustments

- For all offset and gain adjustments, adjust *through* the bandpass: Keep adjusting until the power peaks and then drops off. Then reset the adjustment to the peaked point.
- For all offset and gain adjustments, if power stays peaked over several calibration constant values, set the calibration constant to the middle value of the peaked range.

### Squegg Clamp Calibration Constants

The squegg clamp calibration constants are adjusted to decrease the clamp on the SYTM as far as possible to achieve the greatest power without squegging.

- When increasing any squegg clamp calibration constant, power is increased too far when any of the following occurs:
  - Any portion of the trace is distorted or power drops out in a portion of the trace (sphere squegging).
  - Power drops over a broad frequency range (diode squegging).
  - Power stops increasing on any portion of the trace.
- Diode squegging is the primary form of squegging in band 2.
- Sphere squegging is the only form of squegging in band 1.
- After increasing power to the peak, decrease power by 1.5 to 2 dB across the entire band. Power should decrease uniformly across the entire band.

### Adjusting for a Dip

- When adjusting for a dip at the high end of the band, adjust until the power peaks, then dips (reaches minimum power). Dips may be smaller than 1/3 division ( $\cong 0.5$  dB.) Note the calibration constant where this occurs. Continue adjusting in the same direction until the power peaks again. Return the adjustment to the power level of the dip.
- The passband of the SYTM varies with frequency. The SYTM adjustments set the input frequency to the SYTM to the center of the passband. Adjusting for the dip at higher frequencies actually adjusts for the dip which occurs in the center of the passbands of those frequencies (see figure 3-16).

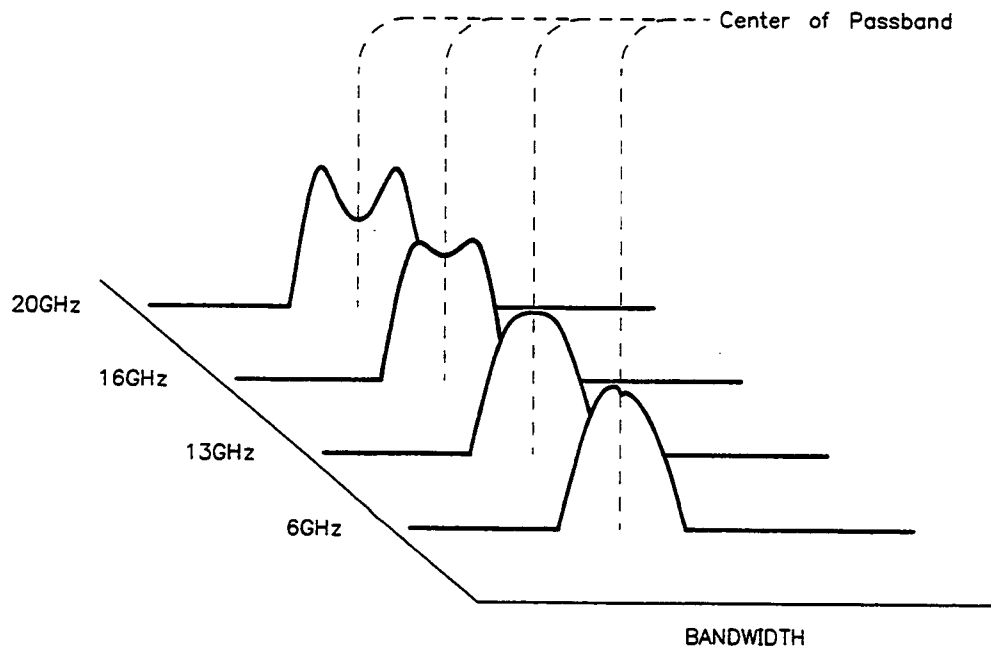

Figure 3-16. SYTM Passband Versus Frequency

### **SRD Bias Adjustment**

- When adjusting the SRD bias, decrease power by 1.3 division ( $\cong 0.5$  dB) after reaching peak power.

### **Single Band Delay Compensation Adjustments**

- If a drop in power greater than 1 division occurs when in single sweep, increase the A delay term to put the A term at the high end of the peak. For example, for the following calibration constant values:

Start of the peak = 1800  
Middle of the peak = 1950  
End of the peak = 2100

Set the A term to 2050

See figure 3-17a for a graphic representation of the frequencies affected by the calibration constants.

### **Sweep Speed Related Adjustments**

- Delay compensation and risetime adjustments are affected by sweep speed. The adjustments are performed at fast sweep speeds which are the worst case. All other adjustments are performed at slow sweep speeds; they are not affected by sweep speed.

If you have a sweep speed problem, it is probably affected by delay compensation or risetime adjustments.

### **YTM Bandcross Delay Terms**

The YTM Bx Dly terms are either offset or gain terms. A1 denotes the offset term for band 1. B1 denotes the gain term for band 1. The offset (A) should be adjusted to maximize power at the beginning of the band. The gain (B) is adjusted to maximize power toward the end of the band.

See figure 3-17 for a graphic representation of the frequencies affected by the calibration constants.

### **YTM RiseTime Compensation**

YTM Risetime compensation minimizes power dropouts that occur at the start of a band. These calibration constants will only help if the dropout does not occur during slow sweep speeds (>500 msec). When adjusting, set the risetime calibration constant to 1, then increment until the power dropout is removed (the smaller the number, the better).

Band 2 has three risetime calibration constants:

YTM Rise; Band 2 A1  
YTM Rise; Band 2 B1  
YTM Rise; Band 2 A2

Band 3 has five risetime calibration constants:

YTM Rise; Band 3 A1

YTM Rise; Band 3 B1

YTM Rise; Band 3 A2

YTM Rise; Band 3 B2

YTM Rise; Band 3 A3

*A1* indicates that the start of sweep is in the lower half of band 1. *B1* indicates that the start of sweep is in the upper half of band 1. *A2* indicates that the start of sweep is in the lower half of band 2. *B2* indicates that the start of sweep is in the upper half of band 2.

If the YTM Rise calibration constant has no effect, set it to 1.

See figure 3-17b for a graphic representation of the frequencies affected by the calibration constants.



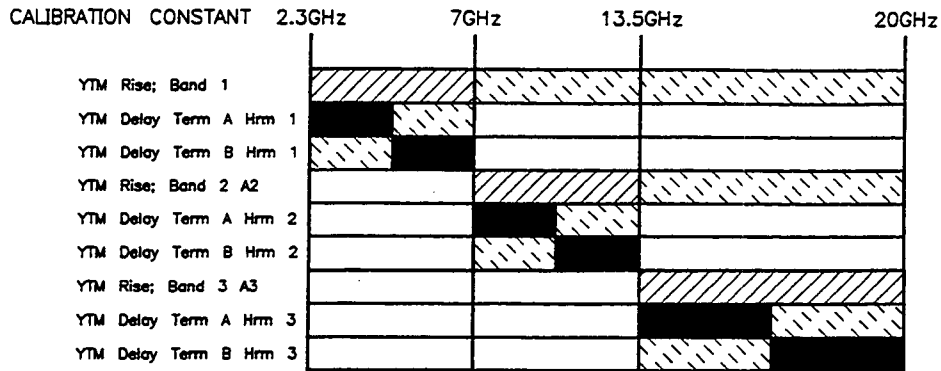
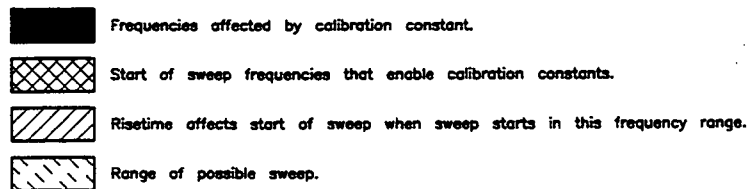
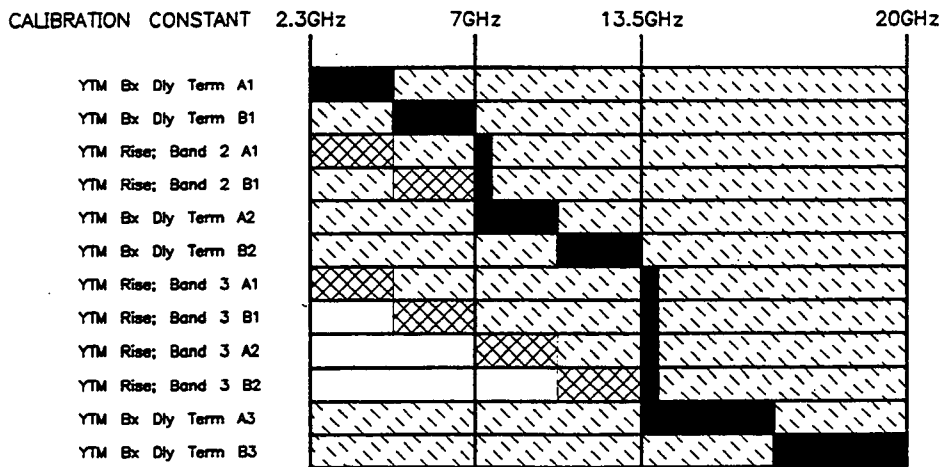

Figure 3-17a. Single-Band Delay and Risetime Compensation



EXAMPLE: YTM Rise; Band 3 B1 affects the beginning of Band 3 when the sweep starts in the second half of Band 1 and ends in Band 3.

Figure 3-17b. Multi-Band Delay and Risetime Compensation

## Procedure

1. Connect the equipment as shown in figure 3-18 with the RF deck installed on an extender board. Use the extender board and extender cable provided in the service kit and see "DISASSEMBLY AND REPLACEMENT PROCEDURES" in the *Assembly-Level Repair* manual for instructions. Disconnect the semi-rigid cable W56 between the A28 SYTM and the A36 pulse modulator (you will need to loosen A36 in order to remove W56). Do not connect the power meter yet. Power on all the instruments and let them warm up for at least one hour.
2. On the synthesizer, set:  
**PRESET** **USER CAL** [*Tracking Menu*] [*Peak RF Always*] (asterisk on)
3. On the power meter:  
Zero and calibrate the power meter/sensor.  
Set the power meter to dBm mode.

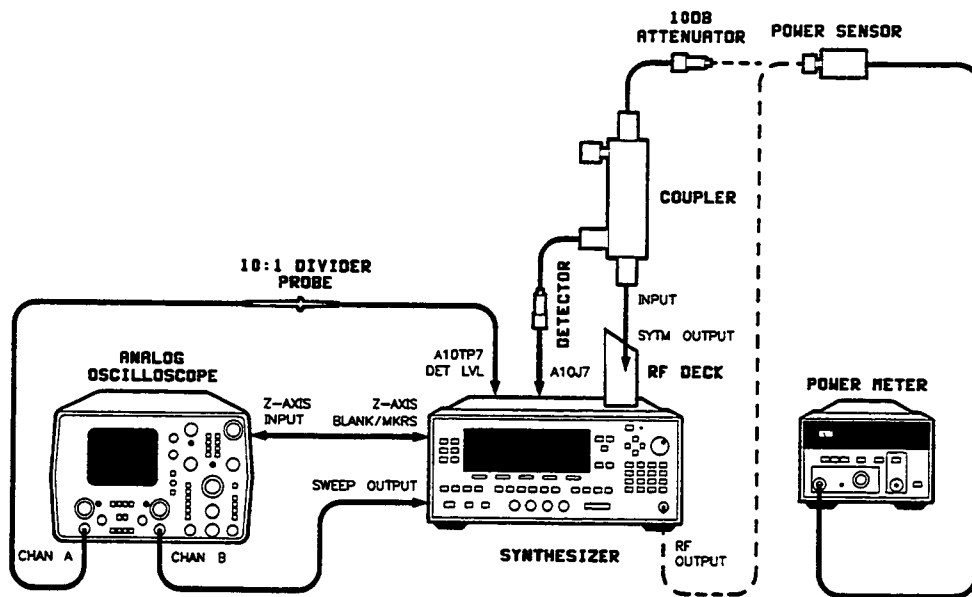

Figure 3-18. SYTM Adjustments Setup

4. Set the default values given in table 3-3 into the corresponding YTM calibration constants. On the synthesizer, set:

**SERVICE** [Adjust Menu] [Calib Menu]

**Select Cal** Enter the number of the first calibration constant from table 3-3 and terminate the entry with **ENTER**.

**[Modify Cal]** Enter the default value from table 3-3 and terminate the entry with **ENTER**.

Using the up/down arrow keys, select each of the rest of the calibration constants in table 3-3 and set their default values by entering the value on the numeric keypad. Terminate your entry with the **ENTER** key.

*Table 3-3. YTM Calibration Constants and Default Values (1 of 3)*

Number	Description	Default Value	Adjustment Description
105	SRD Bias A; Band 1	50	Maximize power over lower 30% of band. Sweep speed is not a factor. Adjust for 0.5 dB below maximum power.
106	SRD Bias A; Band 2	80	
107	SRD Bias A; Band 3	80	
108	SRD Bias A; Band 4	80	
109	SRD Bias A; Band 5	80	
110	SRD Bias A; Band 6	80	
111	SRD Bias A; Band 7	80	
118	SRD Bias B; Band 1	50	Maximize power over higher 30% of band. Sweep speed is not a factor. Adjust for 0.5 dB below maximum power.
119	SRD Bias B; Band 2	80	
120	SRD Bias B; Band 3	80	
121	SRD Bias B; Band 4	80	
122	SRD Bias B; Band 5	80	
123	SRD Bias B; Band 6	80	
124	SRD Bias B; Band 7	80	
131	Squegg Clamp 1A	85	Maximize power across the first half of the band without squegging. Adjusted at slow sweep speeds and single sweep mode where the SYTM sphere is most likely to squegg.
132	Squegg Clamp 2A	125	
133	Squegg Clamp 3A	125	
134	Squegg Clamp 4A	125	
135	Squegg Clamp 5A	125	
136	Squegg Clamp 6A	125	
137	Squegg Clamp 7A	125	
144	YTM Delay Term A Hrm 1	1600	Maximize power over first 20% of band. Affects fast sweeps only. Single sweep mode is also critical.
145	YTM Delay Term A Hrm 2	1600	
146	YTM Delay Term A Hrm 3	1600	
147	YTM Delay Term A Hrm 4	1600	
148	YTM Delay Term A Hrm 5	1600	
149	YTM Delay Term A Hrm 6	1600	
150	YTM Delay Term A Hrm 7	1600	

Table 3-3. YTM Calibration Constants and Default Values (2 of 3)

Number	Description	Default Value	Adjustment Description
157	YTM Delay Term B Hrm 1	300	Maximize power over higher 30% of band. Affects fast sweeps only.
158	YTM Delay Term B Hrm 2	300	
159	YTM Delay Term B Hrm 3	300	
160	YTM Delay Term B Hrm 4	300	
161	YTM Delay Term B Hrm 5	300	
162	YTM Delay Term B Hrm 6	300	
163	YTM Delay Term B Hrm 7	300	
170	YTM Bx Dly Term A1	1600	Delay compensation for multi-band sweeps only. Adjust for maximum power at lower 50% of band. Affects fast sweep speeds only.
171	YTM Bx Dly Term A2	1600	
172	YTM Bx Dly Term A3	1600	
173	YTM Bx Dly Term A4	1600	
174	YTM Bx Dly Term A5	1600	
175	YTM Bx Dly Term A6	1600	
176	YTM Bx Dly Term A7	1600	
183	YTM Bx Dly Term B1	300	Delay compensation for multi-band sweeps only. Adjust for maximum power at higher 30% of band. Affects fast sweep speeds only.
184	YTM Bx Dly Term B2	300	
185	YTM Bx Dly Term B3	300	
186	YTM Bx Dly Term B4	300	
187	YTM Bx Dly Term B5	300	
188	YTM Bx Dly Term B6	300	
189	YTM Bx Dly Term B7	300	
195	YTM Kick Threshold	110	Default values are not altered. Numbers should remain unchanged.
196	YTM CW Kick Max	9000	
197	YTM Mono Band Kick	2000	
198	YTM Stereo Band Kick	2000	
199	YTM Slew Rate	400	
200	YTM Slew Max	50	
201	YTM Slew Min	0	
202	YTM Neg Kick Wait	2	
203	YTM Fwd Kick Pct	50	
204	YTM Fwd Kick Wait	30	
205	YTM Rise; Band 1	15	Minimize power dropouts at the start of band. Adjustment is only effective at fast sweep speeds.
206	YTM Rise; Band 2 A1	25	
207	YTM Rise; Band 2 B1	2	
208	YTM Rise; Band 2 A2	15	
209	YTM Rise; Band 3 A1	70	
210	YTM Rise; Band 3 B1	7	
211	YTM Rise; Band 3 A2	70	
212	YTM Rise; Band 3 B2	7	
213	YTM Rise; Band 3 A3	15	
214	YTM Rise; Band 4	15	
215	YTM Rise; Band 5	15	
216	YTM Rise; Band 6	15	
217	YTM Rise; Band 7	15	

Table 3-3. YTM Calibration Constants and Default Values (3 of 3)

Number	Description	Default Value	Adjustment Description
225	*YTM Gain Band 1	2048	Maximize power over higher 10% of band. Adjust at slow sweep speeds.
226	*YTM Gain Band 2	2048	
227	*YTM Gain Band 3	2048	
228	*YTM Gain Band 4	2048	
229	*YTM Gain Band 5	2048	
230	*YTM Gain Band 6	2048	
231	*YTM Gain Band 7	2048	
238	*YTM Offset Band 1	2048	Maximize power over lower 10% of band. Adjust at slow sweep speeds.
239	*YTM Offset Band 2	2048	
240	*YTM Offset Band 3	2048	
241	*YTM Offset Band 4	2048	
242	*YTM Offset Band 5	2048	
243	*YTM Offset Band 6	2048	
244	*YTM Offset Band 7	2048	
248	YTM B2 Offset Offset	0	Maximize power at the start of band 2. Adjust at slow sweep speeds.
335	Squegg Clamp 1B	141	Maximize power across the second half of the band without squegging. Adjusted at slow sweep speeds and single sweep mode where the SYTM sphere is most likely to squegg.
336	Squegg Clamp 2B	162	
337	Squegg Clamp 3B	190	
338	Squegg Clamp 4B	162	
339	Squegg Clamp 5B	190	
340	Squegg Clamp 6B	190	
341	Squegg Clamp 7B	255	
373	YTM Dly Term C Hrm 1	50	
374	YTM Dly Term C Hrm 2	30	
375	YTM Dly Term C Hrm 3	30	
376	YTM Dly Term C Hrm 4	0	
377	YTM Dly Term C Hrm 5	0	
378	YTM Dly Term C Hrm 6	0	
379	YTM Dly Term C Hrm 7	0	
382	YTM Bx Dly Term C1	0	
383	YTM Bx Dly Term C2	0	
384	YTM Bx Dly Term C3	40	
385	YTM Bx Dly Term C4	0	
386	YTM Bx Dly Term C5	0	
388	YTM Bx Dly Term C6	0	
525	Hibernation Time	90	
526	Bandcross 1	42	
527	Bandcross 2	32	
528	Bandcross 3	28	
529	Bandcross 4	50	
530	Bandcross 5	28	
531	Bandcross 6	20	
532	Bandcross 7	20	

## YTM Gain Adjustment

### Band 1 Adjustment

#### Note



If the synthesizer has a step attenuator (option 001), the 10 dB fixed attenuator can be eliminated by uncoupling the step attenuator and setting it to 10 dB (use the power menu).

5. On the synthesizer, set:

**START** **2.3** **GHz** (synthesizers with a lowest start frequency of 10 MHz)

**START** **2** **GHz** (synthesizers with a lowest start frequency of 2 GHz)

**STOP** **7** **GHz**

**SWEEP TIME** **200** **msec**

**POWER LEVEL** **25** **dBm**

Note that the synthesizer has unlevelled output power.

6. On the oscilloscope, set:

Channel A: 5 mV/Division

Offset: As required

Input Coupling: dc

Input Impedance: 1 M $\Omega$

Channel B: 1 V/Division

Offset: As required

Input Coupling: dc

Input Impedance: 1 M $\Omega$

Sweep Mode: A versus B

Adjust Channel B offset and volts/division for a trace that fills the full horizontal display.

7. Set A12R5 DROOP fully counterclockwise.
8. Set A12S1 switch 5 to OPEN.
9. Adjust A12R69 GAIN to maximize high end power (last two horizontal display divisions).
10. Modify calibration constant #238, YTM Offset; Band 1, to maximize low end power.

#### Note



If the power level of the left side of the display cannot be adjusted to the same as the right side, lower the right side with the B calibration constant. Then readjust the A term.

- 11 Adjust calibration constant #335, Squegg Clamp 1B, for maximum power without distortion or breakup on the right half of the display.

Adjust calibration constant #131, Squegg Clamp 1A, for approximately the same power level. Figure 3-19 shows an example of properly adjusted squegg clamp calibration constants (a) and the same adjustment showing a low end power dropout (b).

12. Repeat steps 9 through 11 until the entire band is peaked.

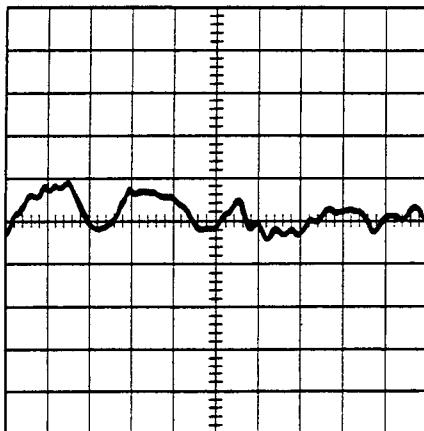

(a) No squegging

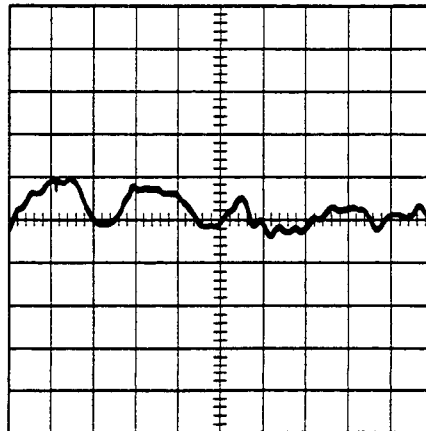

(b) Start of squegging

Figure 3-19. Squegg Clamp Band 1 Adjustment

13. Note the value of calibration constant #238, YTM Offset; Band 1 \_\_\_\_\_.

Vary this calibration constant  $\pm 50$  counts and verify that the power change is uniform across the entire band. If the power change is not uniform, repeat steps 9 through 11 again.

#### Band 2 Adjustment

14. On the synthesizer, set:

START 7 GHz

STOP 13.5 GHz

CONT SWEEP TIME 200 msec

15. Set the oscilloscope vertical position as necessary to display the trace.
16. Modify calibration constant #226, YTM Gain; Band 2, to maximize high end power.
17. Modify calibration constant #239, YTM Offset; Band 2, to maximize low end power.

18. Adjust band 2 SRD bias calibration constants as follows:

- a. Increment calibration constant #106, SRD Bias A; Band 2, to maximize low end power.
- b. Decrement calibration constant #106, SRD Bias A; Band 2, to decrease power by  $\cong 1/3$  division (0.5 dB.)
- c. Increment calibration constant #119, SRD Bias B; Band 2, to maximize high end power.
- d. Decrement calibration constant #119, SRD Bias B; Band 2, to decrease power by  $\cong 1/3$  division.

**Note**



If the power level of the left side of the display cannot be adjusted to the same as the right side, lower the right side with the B calibration constant. Then readjust the A term.

19. Adjust calibration constant #336, Squegg Clamp 2B, for maximum power without distortion or breakup on the right half of the display.

Adjust calibration constant #132, Squegg Clamp 2A, for approximately the same power level.

20. Repeat steps 16 thru 19 until the entire band is peaked.

21. Note the value of calibration constant #239, YTM Offset; Band 2 \_\_\_\_\_.

Vary this calibration constant  $\pm 50$  counts and verify that the power change on the analyzer is uniform across the entire band. If not, repeat steps 14 through 20.

**Band 3 Adjustment**

22. On the synthesizer, set:

(START) (13.5) (GHz)

(STOP) (20) (GHz)

(CONT) (SWEEP TIME) (200) (msec)

23. Set A12R25 B3SL1 fully clockwise.

24. Adjust calibration constant #227, YTM Gain; Band 3, for the dip at the high end (see "Adjustment Help").

25. Modify calibration constant #240, YTM Offset; Band 3, to maximize low end power.

**Note**



If the power level of the left side of the display cannot be adjusted as high as required, adjust it to the highest point possible without squegging.



26. Adjust calibration constant #337, Squegg Clamp 3B, for maximum power without distortion or breakup on the right half of the display.

Adjust calibration constant #133, Squegg Clamp 3A, for approximately the same power level. See figure 3-20 for an example of a properly adjusted trace (a) and the same trace where power has stopped increasing in the part of the low end of the band (b).

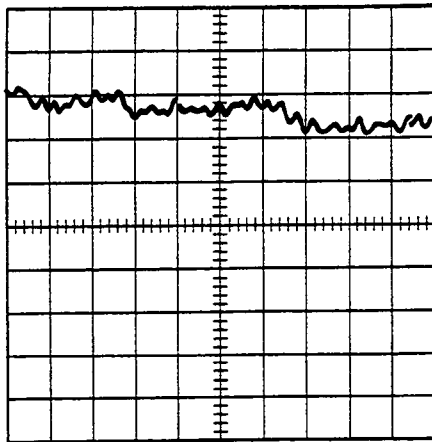

(a) Adjusted for maximum power

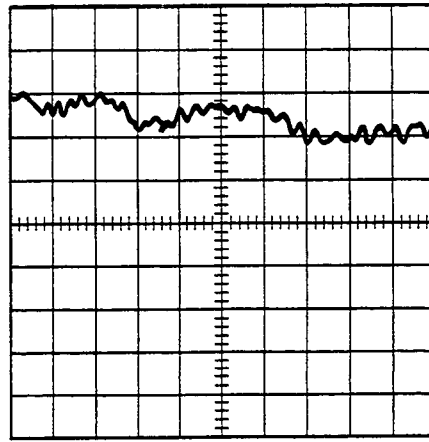

(b) No further increase in power

Figure 3-20. Squegg Clamp Band 3 Adjustment

27. Set the band 3 SRD bias calibration constants as follows:
- Increment calibration constant #120, SRD Bias B; Band 3, to maximize high end power.
  - Decrement calibration constant #120, SRD Bias B; Band 3, to decrease power by  $\cong 1/3$  division.
  - Increment calibration constant #107, SRD Bias A; Band 3, to maximize low end power.
  - Decrement calibration constant #107, SRD Bias A; Band 3, to decrease power by  $\cong 1/3$  division.
28. Repeat steps 24 thru 27 until power is optimized over the full band. Power is optimized when the SYTM offset adjustment causes a peak in power at the start of the band coincident with a dip in power at the end of the band (see the properly adjusted trace in figure 3-20).

### Auto Tracking Verification

29. Record the value of the following calibration constants:

- #225 YTM Gain Band 1 \_\_\_\_\_
- #226 YTM Gain Band 2 \_\_\_\_\_
- #227 YTM Gain Band 3 \_\_\_\_\_
- #228 YTM Gain Band 4 \_\_\_\_\_
- #229 YTM Gain Band 5 \_\_\_\_\_
- #230 YTM Gain Band 6 \_\_\_\_\_
- #231 YTM Gain Band 7 \_\_\_\_\_
  
- #238 YTM Offset Band 1 \_\_\_\_\_
- #239 YTM Offset Band 2 \_\_\_\_\_
- #240 YTM Offset Band 3 \_\_\_\_\_
- #241 YTM Offset Band 4 \_\_\_\_\_
- #242 YTM Offset Band 5 \_\_\_\_\_
- #243 YTM Offset Band 6 \_\_\_\_\_
- #244 YTM Offset Band 7 \_\_\_\_\_

30. Disconnect the coupler from the A28 SYTM. Reconnect the high band detector cable to the CR1 high band detector. Connect the semi-rigid cable W56 between the A28 SYTM and the A36 pulse modulator. Connect the power meter through a 10 dB attenuator to the RF OUTPUT connector.

31. Initiate auto tracking on the synthesizer as follows. Terminate the RF OUTPUT with a good 50Ω impedance match such as a 10 dB attenuator or a power sensor (not necessary for synthesizers with a step attenuator.) Press:

**USER CAL** [*Tracking Menu*] [*Auto Track*]

Watch while the synthesizer completes auto tracking. Note if auto tracking is particularly slow in any band. If auto tracking fails (an error message is displayed) repeat the gain and offset adjustments for the failed frequency.

### Note



If the synthesizer fails the power output specifications, perform steps 42 through 44 and then repeat the auto tracking procedure.

32. On the synthesizer, set:

- START** (2.3) **GHz**
- STOP** (20) **GHz**
- SWEEP TIME** (1.5) **sec**
- POWER LEVEL** (25) **dBm**

33. Manually sweep the full frequency range to find the minimum power point. On the power meter, check that the power at this point is not below the specified maximum leveled power (note that power is attenuated by 10 dB). If it is, check the following:
  - a. Check the squegging clamp calibration constant for the respective band. Increase the power if needed by increasing the clamp calibration constant value on the SYTM.
  - b. Compare the manually adjusted YTM gain and YTM offset calibration constants (step 29) to the auto tracked calibration constants. A large difference in values (several hundred counts) indicates a possible misadjustment. The auto tracking values are correct. Big differences indicate where improvements in adjustment technique can be made.
34. Set the synthesizer power level to the specified maximum leveled power. Check for ALC oscillations or level squegging.
  - a. The SRD bias A or B calibration constants for the affected band might eliminate oscillation. The problem is with the A term if the oscillations are near the beginning of the band. It is with the B term if the oscillations are near the end of the band. SRD bias has a range. It can be underbiased which causes level squegging. If so, increase the value of the SRD bias calibration constants and repeat the adjustment.
  - b. If the SRD bias calibration constants have no effect, check the ALC Mod Gain calibration constant for the appropriate band.
35. Try single sweeps over various frequency ranges such as 5 GHz to 20 GHz or 10 GHz to 20 GHz. Set the sweep times to greater than 200 msec for single-band and less than 1.5 sec for multi-band sweeps since delay compensation has not yet been adjusted. Problems here are typically associated with sphere heating while awaiting the start of sweep trigger. If necessary adjust the squegging clamp calibration constant for the appropriate band.

### Tracking

36.
  - a. Note the minimum power point in the right half of the display.
  - b. Press SWEEP **(MENU)** [*Manual Sweep*] (asterisk on) and manually sweep the synthesizer to the minimum power point noted in step a.
  - c. Note the power meter indication. If it is  $>3.5$  dB above the specified maximum leveled power, adjust calibration constant #335, Squegg Clamp 1B, for an RF output power of 3.5 dB above the specified maximum leveled power. If it is  $<3.5$  dB above specified maximum leveled power, do not readjust the squegg clamp.
37.
  - a. Adjust the oscilloscope vertical offset to position the trace (a dot in manual sweep) on a horizontal graticule.
  - b. Select continuous sweep.
  - c. Adjust calibration constant #131, Squegg Clamp 1A, to position the minimum power point in the left half of the display at the same horizontal graticule chosen in step a.
  - d. If necessary, readjust calibration constant #335, Squegg Clamp 1B, to position the minimum power point on the horizontal graticule chosen in step 1.
38. Disconnect the semi-rigid cable W56 from between the A28 SYTM and the A36 pulse modulator. Connect the power meter through a 10 dB attenuator to the SYTM output connector.
39. On the synthesizer, set:  
**(START)** **(2.3)** **(GHz)** (synthesizers with a lowest start frequency of 10 MHz)  
**(START)** **(2)** **(GHz)** (synthesizers with a lowest start frequency of 2 GHz)  
**(STOP)** **(7)** **(GHz)**  
**(CONT)** **(SWEEP TIME)** **(200)** **(msec)**
  - a. Note the minimum power point on the oscilloscope display.
  - b. Press SWEEP **(MENU)** [*Manual Sweep*] (asterisk on) and manually sweep the synthesizer to the minimum power point from step a.
40. If the minimum power point, read from the power meter, exceeds 12 dBm, decrease the value of the squegg clamp 1B calibration constant #335 until this power level is reached. Next, adjust the squegg clamp 1A calibration constant #131 until the minimum power point of the left side exceeds 12 dBm.
41. Repeat steps 39 and 40 for the following start and stop frequencies, squegg clamp calibration constants, and power levels shown in table 3-4.

Table 3-4. Minimum Power Point Settings

Frequency (GHz)	Squegg Clamp Calibration Constant		Power Level (dBm)	
	1B	1A	1B	1A
7 to 13.5	336	132	12	12
13.5 to 20	337	133	15	12*

\* If power is not high enough, set the squegg clamp calibration constant to 255.

42. Disconnect the power meter. Reconnect channel A through the 10:1 probe, and the coupler to the SYTM output. Connect the 10 dB attenuator to the coupler output. Connect the high band ALC detector cable to the detector on the coupler.
43. On the synthesizer, set:
  - (START) (2.3) (GHz)
  - (STOP) (13.5) (GHz)
  - (SWEEP TIME) (500) (msec)
  - (POWER EVEL) (25) (dBm)
44. Adjust calibration constant #248, YTM B2 Offset Offset, to maximize power at the start of band 2. If necessary, set a marker to 7 GHz to identify the start of band 2.

### Single Band SYTM Delay and Risetime Compensation

45. On the synthesizer, set:
  - (START) (2.3) (GHz) (synthesizers with a lowest start frequency of 10 MHz)
  - (START) (2) (GHz) (synthesizers with a lowest start frequency of 2 GHz)
  - (STOP) (7) (GHz)
  - (CONT) (SWEEP TIME) (0) (msec)
  - (POWER LEVEL) (25) (dBm)

Note that the synthesizer has unlevelled output power.

### Band 1 Adjustment

#### Note



Since YTM Rise; Band 1 is set to the default value, a spike at the beginning of band 1 may be present.

46. Adjust calibration constant #144, YTM Dly Term A Hrm 1, to maximize power for the low end of band 1. Set the calibration constant for the middle of the peaked range.

47. Adjust calibration constant, #157 YTM Dly Term B Hrm 1, to maximize power for the high end of band 1. Set the calibration constant for the middle of the peaked range.
48. Adjust calibration constant #205, YTM Rise; Band 1, to minimize power dropout at the start of band 1.
49. Switch between the fastest sweep time and 200 msec sweep time and check that power changes less than 2/3 division ( $\cong 1$  dB.) If not, repeat steps 46 and 47.
50. On the synthesizer, set:
 

(SWEEP TIME) (0) (msec)
51. Press (SINGLE) several times to initiate several sweeps. If a drop in power greater than 1 division occurs when in single sweep, increase the A term of the delay adjustment #144 to put the A term at the high end of the peak (see "Adjustment Help").

### Band 2 Adjustment

52. On the synthesizer, set:
 

(START) (7) (GHz)

(STOP) (12.5) (GHz)

(CONT) (SWEEP TIME) (0) (msec)
53. Adjust calibration constant #145, YTM Dly Term A Hrm 2, to maximize power for the low end of band 2.
54. Adjust calibration constant #158, YTM Dly Term B Hrm 2, to maximize power for the high end of band 2.
55. Adjust calibration constant #208, YTM Rise; Band 2 A2, to maximize power dropout at the low end of band 2.
56. Switch between the fastest sweep time (0 msec) and 200 msec sweep time and check that power changes less than  $\cong 2/3$  division. If not, repeat steps 53 and 54.
57. On the synthesizer, set:
 

(SWEEP TIME) (0) (msec)
58.
  - a. Press (SINGLE) several times to initiate several sweeps. Note any drop in power.
  - b. Press (SINGLE) (RF ON/OFF). Then press (RF ON/OFF) again (LED on) and note the drop in power.
  - c. The power loss noted in step a can be no smaller than the power loss noted in step b. If the step a power loss is greater than the step b power loss by 1 division ( $\cong 1.5$  dB), increase the A term of the delay adjustment #145 to put the A term at the high end of the peak (see "Adjustment Help").

### Band 3 Adjustment

59. On the synthesizer, set:
 

(START) (13.5) (GHz)

(STOP) (20) (GHz)

(CONT) (SWEEP TIME) (0) (msec)

60. Adjust calibration constant #146, YTM Dly Term A Hrm 3, to maximize power for the low end of band 3.
61. Adjust calibration constant #159, YTM Dly Term B Hrm 3, to maximize power for the high end of band 3 as follows:
  - a. Offset the calibration constant enough to cause an extreme power loss in band 3.
  - b. Slowly adjust the calibration constant for the dip at the high end of the band (see "Adjustment Help"). The difference between the peak and the dip may be less than 1/3 division.
62. Adjust calibration constant #213, YTM Rise; Band 3 A3, to minimize power dropout at the start of band 3.
63. Switch between the fastest sweep time (0 msec) and 200 msec sweep time and check that power changes less than 2/3 division ( $\cong 1$  dB). If necessary, repeat steps 60 and 61.
64. On the synthesizer, set:
 

(SWEEP TIME) (0) (msec)
65. a. Press (SINGLE) several times to initiate several sweeps. Note any drop in power.
  - b. Press (SINGLE) (RF ON/OFF) . Then press (RF ON/OFF) again (LED on) and note the drop in power.
  - c. The power loss noted in step a can be no smaller than the power loss noted in step b. If the step a power loss is greater than the step b power loss by 1 division ( $\cong 1.5$  dB), increase the A term of the delay adjustment #146 to put the A term at the high end of the peak (see "Adjustment Help").

## Multiband SYTM Delay and Risetime Compensation

### Note



Power dropouts at the start of each band are typically removed with the YTM Risetime calibration constants. These will be adjusted later.

66. On the synthesizer, set:

(START) (13) (GHz)  
 (STOP) (20) (GHz)  
 (CONT) (SWEEP TIME) (0) (msec)  
 (POWER LEVEL) (25) (dBm)

69. Adjust calibration constant #185, YTM Bx DLY Term B3, as follows:
- Offset the calibration constant enough to cause an extreme power loss in band 3.
  - Slowly adjust the calibration constant for the dip at the high end of the band (see "Adjustment Help").
70. Switch between the fastest sweep time (0 msec) and 200 msec sweep time and check that power changes less than 2/3 division ( $\cong 1$  dB). If the change in power is greater than 2/3 division, readjust the A term of the delay adjustment #172 for low end problems, or the B term of the delay adjustment #185 for high end problems.
71. On the synthesizer, set:
- SWEEP TIME** **0** **msec**
72. Press **SINGLE** several times to initiate several sweeps. If a drop in power greater than 1 division occurs when in single sweep, increase the A term of the delay adjustment #172 to put the A term at the high end of the peak (see "Adjustment Help").
73. On the synthesizer, set:
- START** **7** **GHz**
- CONT** **SWEEP TIME** **0** **msec**
74. Adjust calibration constant #171, YTM Bx Dly Term A2, to maximize power at the start of band 2 (start of sweep).
75. Adjust calibration constant #184, YTM Bx Dly Term B2, to maximize power at the end of band 2.
76. Adjust calibration constant #211, YTM Rise; Band 3 A2, to minimize power dropout at the start of band 3. Figure 3-21 shows the calibration constant correctly adjusted (a) and misadjusted (b).



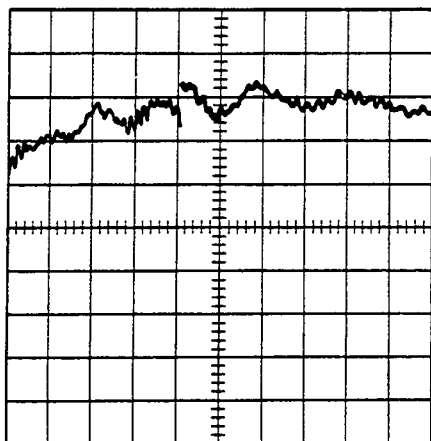

(a) Correctly adjusted

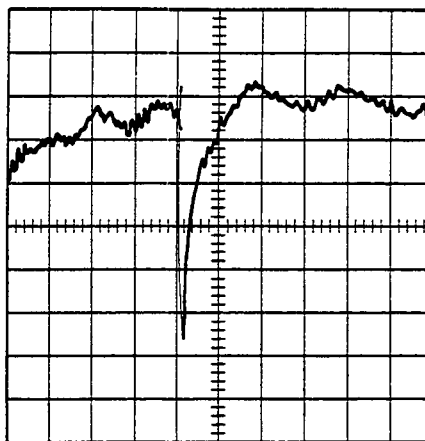

(b) Misadjusted

Figure 3-21. Band 3 A2 YTM Risetime Adjustment

77. Switch between the fastest sweep time (0 msec) and 500 msec sweep time and check that power changes less than 2/3 division ( $\cong 1$  dB) across both bands. If the change is greater than 2/3 division, readjust the appropriate delay term.
78. On the synthesizer, set:
  -
79. Press  several times to initiate several sweeps. If a drop in power greater than 1 division occurs when in single sweep, readjust the appropriate delay term for the location of the problem.
80. On the synthesizer, set:
  - 
  -
81. Adjust calibration constant #212, YTM Rise; Band 3 B2, to minimize power dropout at the start of band 3. Do *not* allow the value of this calibration constant to be greater than 1/5 the value of #211, YTM Rise; Band 3 A2.

82. Press **(SINGLE)** several times to initiate several sweeps. If a drop in power greater than 1/3 division occurs when in single sweep, readjust the appropriate delay or risetime term for the location of the problem.
83. On the synthesizer, set:
- (START)** **(2.3)** **(GHz)**
- (CONT)** **(SWEEP TIME)** **(0)** **(msec)**
- (MARKER)** **[Marker M2]** **(7)** **(GHz)** (asterisk on)
84. Adjust calibration constant #170, YTM Bx Dly Term A1, to maximize power at the start of band 1.
85. Adjust calibration constant #183, YTM Bx Dly Term B1, to maximize power at the high end of band 1.
86. Adjust calibration constant #209, YTM Rise; Band 3 A1, to minimize power dropout at the start of band 3.
87. Adjust calibration constant #206, YTM Rise; Band 2 A1, to minimize power dropout at the start of band 2.
88. Switch between the fastest sweep time (0 msec) and 1 sec sweep time and check that power changes less than 2/3 division ( $\cong 1$  dB) across all bands. If the change is greater than 2/3 division, readjust the appropriate delay term.
89. On the synthesizer, set:
- (SWEEP TIME)** **(0)** **(msec)**
90. Press **(SINGLE)** several times to initiate several sweeps. Note the drop in power in all bands. If a drop in power greater than 1 division occurs when in single sweep, readjust the appropriate delay or risetime term for the location of the problem.
91. On the synthesizer, set:
- (START)** **(5)** **(GHz)**
- (CONT)**
- (SWEEP TIME)** **(0)** **(msec)**
92. Adjust calibration constant #210, YTM Rise; Band 3 B1, to minimize power dropout at the start of band 3. Do *not* allow the value of this calibration constant to be greater than 1/5 the value of #209, YTM Rise; Band 3 A1.
93. Press **(SINGLE)** several times to initiate several sweeps. If a drop in power greater than 1 division occurs when in single sweep, readjust the appropriate delay or risetime term.
94. Reinstall the RF deck in the instrument, removing the extender board and extender cable, and reconnecting W56 between the A28 SYTM and the A36 pulse modulator.

95. For the following start and stop frequencies:

0.01 to 20 GHz (synthesizers with a lowest start frequency of 10 MHz)

2 to 20 GHz (synthesizers with a lowest start frequency of 2 GHz)

4.5 to 18 GHz

10 to 20 GHz

2 to 14.5 GHz

Compare sweeps of 0 msec and 1 sec and also single sweeps at fast speed. If a power drop of 0.5 division or greater is noted, readjust the appropriate calibration constant.

96 Connect the power meter/sensor through the 10 dB attenuator to the synthesizer's RF OUTPUT. For the frequencies listed in step 95, manually sweep the synthesizer and compare the minimum power point from the power meter to the specified maximum leveled power. The minimum power point must meet or exceed this level.

97. If this is the last calibration constant you will be adjusting, see "Calibration Constants" to store the calibration constants as protected data (in EEPROM).

## Related Performance Tests

Maximum Leveled Power

### In Case Of Difficulty

1. See "Adjustment Help" in this procedure.
2. Verify the oscilloscope ALC board calibration. When calibrated, the voltage on the oscilloscope is scaled to  $\cong 33$  mV/dB.
3. If you are unable to meet the maximum leveled power specifications, set A29R2 (amplifier detector gain adjustment) fully clockwise. Finish the SYTM adjustment. Perform the amplifier detector gain adjustment.
4. See "TROUBLESHOOTING" in the *Assembly-Level Repair* manual.

## 11. LOW POWER SRD BIAS

### Description and Procedure

The synthesizer is set up for a low power 2 to 20 GHz sweep. The oscilloscope is used to monitor the ALC assembly integrator level signal while the synthesizer is forward sweeping in bands 2 and 3. Then the A9 pulse board MIN adjustment is made to minimize the integrator level signal for both bands.

1. Connect the equipment as shown in figure 3-22. Preset all instruments and let them warm up for at least one hour.

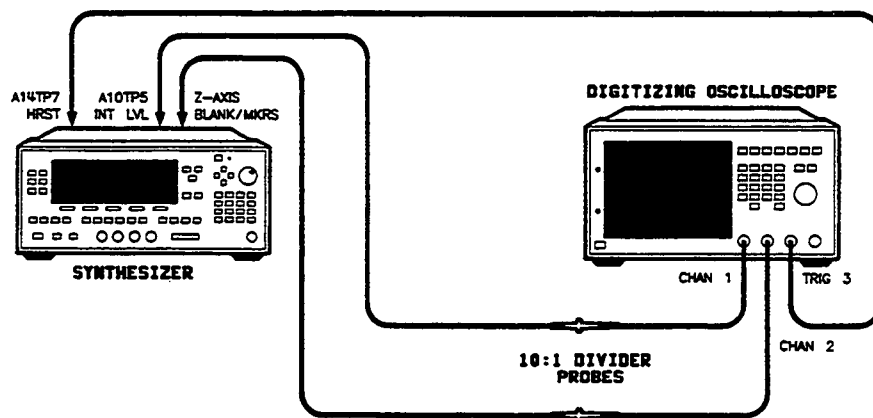

Figure 3-22. Low Power SRD Bias Adjustment Setup

2. On the synthesizer, set:

START 7 GHz

STOP 20 GHz

RF ON/OFF On (amber light is on)

POWER MENU [Uncoupl Atten] (option 001 only)

POWER LEVEL -20 dBm

SWEEP TIME Fastest sweep time

3. On the oscilloscope, set:

**CHANNEL 1:**

Display	On
Volts/Division	0.1V
Input Coupling	dc
Input Impedance	1 M $\Omega$

**CHANNEL 2:**

Display	On
Preset	TTL
Input Impedance	1 M $\Omega$

**TIMEBASE:**

Time/Division	2.2 ms
Delay	-2 ms
Delay Reference	At left
Sweep	Triggered

**TRIGGER:**

Trigger Mode	Events
Trigger	After negative edge
Trigger Source	Trig 3
Trigger	On 1 events
Trigger	Of negative edge
Trigger	On channel 2

**DISPLAY:**

Display Mode	Repetitive
Averaging	Off
Display Time	0.2s

4. Adjust the oscilloscope channel 1 offset and timebase settings as necessary to center the traces on the display.
5. Save the oscilloscope setup in register 1.
6. On the oscilloscope, set:

**Timebase:**

Time/Division	3 ms
---------------	------

**Trigger:**

Trigger	On 2 events
---------	-------------

7. Adjust the oscilloscope channel 1 offset and timebase settings as necessary to center the traces on the display.
8. Save the oscilloscope setup in register 2. Recall register 1.
9. Alternate between registers 1 and 2 and adjust A9R105 (MIN) for the minimum overall voltage as shown in figure 3-23. See figure 3-24 for the location of A9R105.

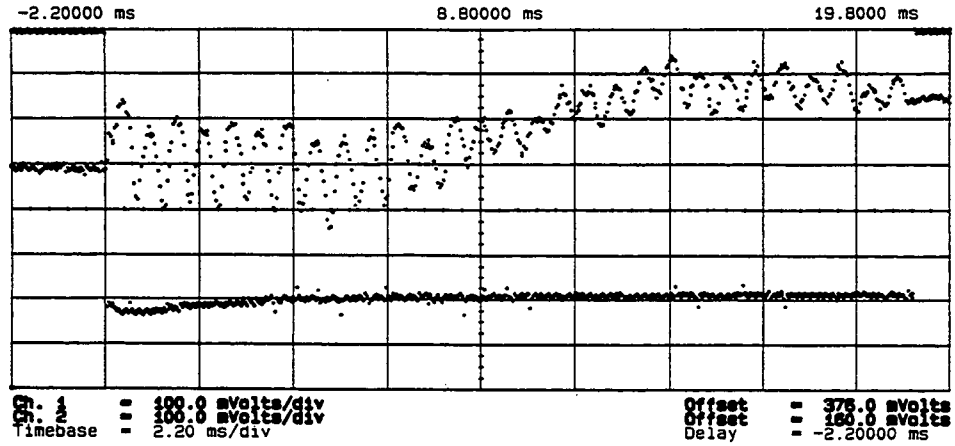

Figure 3-23. A9 Pulse Board MIN Adjustment

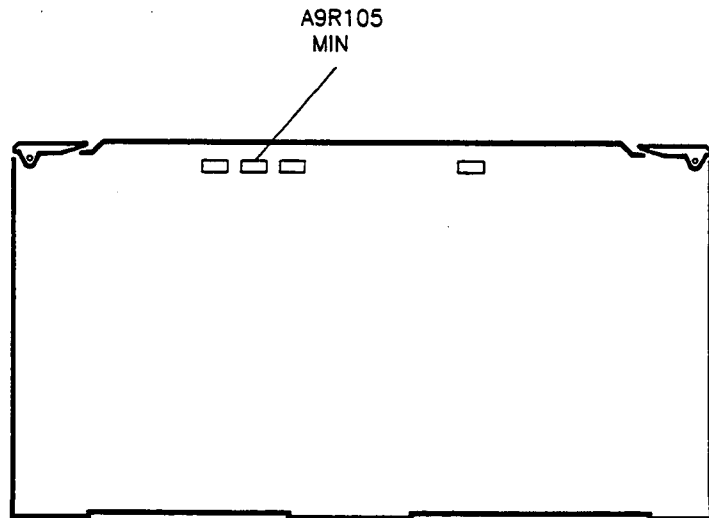

Figure 3-24. A9R105 Location

## **Related Performance Tests**

Power Flatness  
Power Accuracy  
AM Accuracy

## **In Case of Difficulty**

See "TROUBLESHOOTING" in the *Assembly-Level Repair* manual.

## 12. AMPLIFIER DETECTOR GAIN

### Description and Procedure

No test equipment is required for this procedure.

In band 1, excessive gain in the amplifier detector will reduce the effective ALC dynamic range. This adjustment sets the amplifier gain level to the minimum required to achieve maximum leveled power. As a result, the ALC modulator maintains its full dynamic range. This adjustment is switched on only for band 1 operation.

1. Install the RF deck on the extender board with all RF cables connected. Use the extender board and extender cable provided in the service kit and see "DISASSEMBLY AND REPLACEMENT PROCEDURES" in the *Assembly-Level Repair* manual for instructions.
2. Preset the synthesizer and allow it to warm up for at least one hour.
3. To achieve peak power, initiate auto tracking on the synthesizer as follows. Terminate the RF OUTPUT with a good 50 ohm impedance match such as a 10 dB attenuator or a power sensor (not necessary for synthesizers with a step attenuator.) Press:

**USER CAL** [Tracking Menu] [Auto Track]

Wait for the synthesizer to complete auto tracking before continuing to the next step.

4. Preset the amplifier detector gain adjustment A29R2 fully clockwise (multi-turn potentiometer). See figure 3-25 for the A29R2 location.

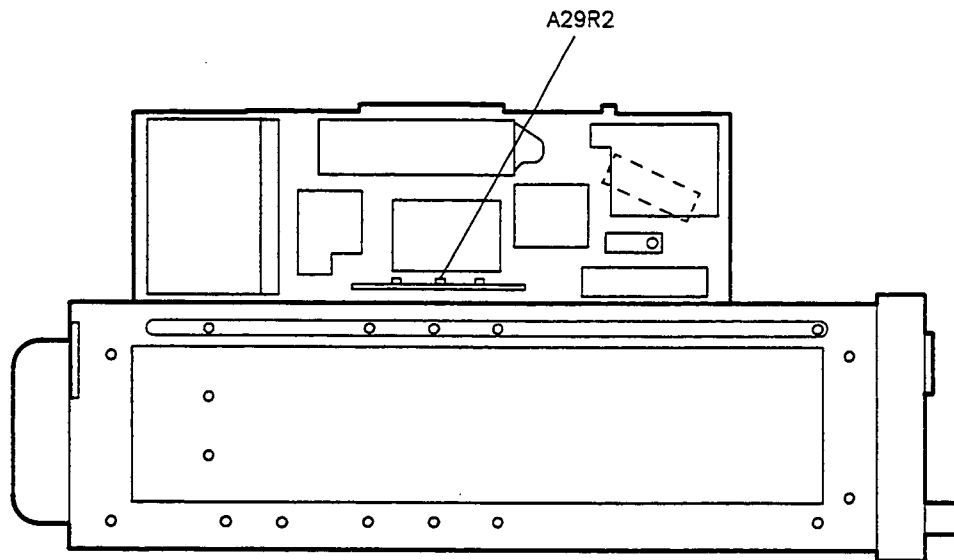

Figure 3-25. A29R2 Location



- 
5. On the synthesizer, set:

START 2.3 GHz

STOP 7 GHz

6. Press **POWER LEVEL** and increase power using the rotary knob until the unlevelled message is displayed. (If the synthesizer will not unlevel, set the power level at the maximum settable power and continue with step 7.)

Decrease power until the unlevelled message turns off.

7. Adjust A29R2 counterclockwise until the synthesizer displays the unlevelled message.

Adjust A29R2 clockwise until the unlevelled message turns off.

8. Turn off power to the synthesizer, disconnect line power, and reinstall the RF deck (see "DISASSEMBLY AND REPLACEMENT PROCEDURES").

### **Related Performance Tests**

Maximum Levelled Power

### **In Case of Difficulty**

See "TROUBLESHOOTING" in the *Assembly-Level Repair* manual.

### 13. MODULATOR OFFSET AND GAIN

#### Description and Procedure

In this procedure, the ALC modulation offset and gain calibration constants are adjusted to linearize the ALC modulator response to the ALC power level reference voltage. Default values are entered for the modulator offset calibration constants and internal firmware is activated to set the modulator gain calibration constants. The synthesizer is then set for a power sweep across the entire leveled ALC range (-20 to +10 dBm). The integrator level signal on the ALC board is monitored to verify linearity. If necessary, the modulator offset values are modified.

1. Connect the equipment as shown in 3-26. Preset the instruments and let them warm up for at least one hour.

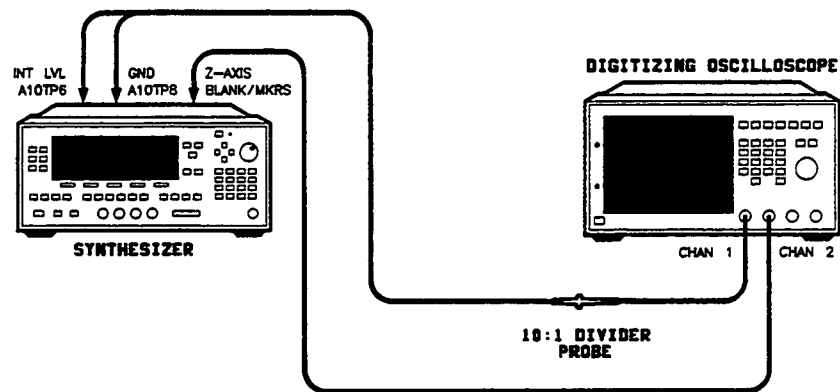

Figure 3-26. Modulator Offset and Gain Adjustment Setup

2. On the synthesizer, set:

**SERVICE** [**Adjust Menu**] [**Calib Menu**]

3. Set the ALC offset calibration constants to the default values given in table 3-5.

Select [**Select Cal**]. Using the numeric keypad, enter the number of the first calibration constant in table 3-5. Terminate your entry with the **ENTER** key.

Select [**Modify Cal**]. Use the numeric keypad to enter the corresponding default value in table 3-5. Terminate your entry with the **ENTER** key.

4. Using the up/down arrow keys, select each of rest of the calibration constants in table 3-5 and set their default values by entering the value on the numeric keypad. Terminate your entry with the **ENTER** key.

*Table 3-5. ALC Offset Calibration Constant Default Values*

Calibration Constant	Description	Default Value
315	ALC Mod Ofs; Band 0	100
316	ALC Mod Ofs; Band 1	100
317	ALC Mod Ofs; Band 2	180
318	ALC Mod Ofs; Band 3	180
319	ALC Mod Ofs; Band 4	150
320	ALC Mod Ofs; Band 5	150
321	ALC Mod Ofs; Band 6	150
322	ALC Mod Ofs; Band 7	150

5. On the synthesizer, set:

**SERVICE** [**Adjust Menu**] [**AssyAdj Menu**] [**A10 Adj Menu**] [**A10 Mod Gain**]

The synthesizer will measure, calculate, and store the modulator gain calibration constants.

When the adjustment is completed the following message appears on the display:

Modulator Gain Cal Completed

Calibration constants were modified.

6. If this is the last calibration constant you will be adjusting, see "Calibration Constants" to store the calibration constants as protected data (in EEPROM).
7. Connect the oscilloscope as shown in figure 3-26.

8. On the oscilloscope, set:

Channel 1:

Display	On
Volts/Division	50 mV
Offset	As necessary
Input Coupling	dc
Input Impedance	1 M $\Omega$

Channel 2:

Display	On
Volts/Division	2V
Input Coupling	dc
Input Impedance	1 M $\Omega$

Timebase:

Time/Division	10 ms
Delay	5 ms
Delay Reference	At left
Sweep	Triggered

Trigger:

Trigger Mode	Edge
Trigger Source	Channel 2
Trigger Level	2V
Trigger Slope	Negative

Display:

Display Mode	Repetitive
Averaging	On
Number of Averages	2

9. On the synthesizer, set:

**CW** **1** **GHz**

**SPAN** **0** **GHz**

**POWER LEVEL** **-** **20** **dBm** \*

**POWER** **MENU** **POWER SWEEP** **30** **dB**

**SWEEP TIME** **100** **mSEC**

**USER CAL** [*Tracking Menu*] [*Peak RF Always*]

\* For synthesizer with step attenuators, do not set the power level in this step. Instead set:

**POWER** **MENU** [*Uncoupl Atten*] [*Set Atten*] **0** **dB** **POWER LEVEL** **-** **20** **dBm**

10. Adjust the oscilloscope timebase so the Z-axis input goes high at the right edge of the display. This signal is low during the power sweep.

11. Change the value of the band 0 calibration constant #315 as needed for a signal variation less than 200 mV during the power sweep (while Z-axis is low).
12. Set the synthesizer to each of the CW frequencies in table 3-6 and repeat step 11 for the corresponding calibration constant.

*Table 3-6. CW Frequencies and Calibration Constants*

<b>CW Frequencies (GHz)</b>	<b>Calibration Constants</b>
5.0	#316 Band 1
9.0	#317 Band 2
19.0	#318 Band 3

### **Related Performance Tests**

Maximum Leveled Power

### **In Case of Difficulty**

See "TROUBLESHOOTING" in the *Assembly-Level Repair* manual.

## 14. ALC POWER LEVEL ACCURACY

### Description and Procedure

This adjustment sets the absolute power accuracy in each frequency band at a CW frequency. The digital ALC calibration array is loaded with zeroes for the 0 dB attenuator setting to eliminate any power offset from this source. Calibration constants set the power accuracy at four power levels. A potentiometer sets the power accuracy at an 18 dBm level in the low band (not applicable for all models).

### Note



This adjustment procedure zeros the digital ALC calibration array at the 0 dB attenuator setting. The "Power Flatness" adjustment must be performed after this procedure.

1. Preset the equipment shown in figure 3-27 and let them warm up for at least one hour. Do *not* connect the power sensor to the synthesizer RF OUTPUT yet.

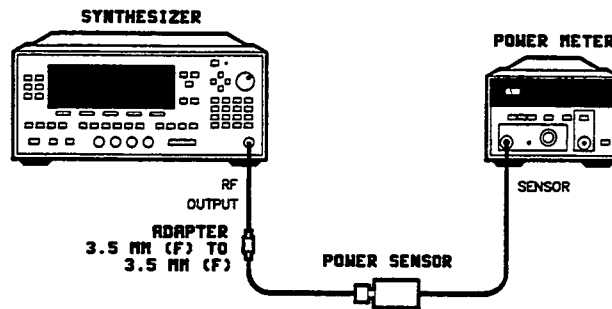

Figure 3-27. ALC Power Accuracy Adjustment Setup

2. Zero and calibrate the power meter/sensor and set the power meter to dBm mode. Connect the power sensor to the synthesizer's RF OUTPUT.

Set the CAL FACTOR % for the power sensor 1 GHz calibration factor.

3. On the synthesizer, set:

**USER CAL** [*Tracking Menu*] [*RF Peak Always*] (asterisk on)

**POWER** **MENU** [*Uncoupl Atten*] (option 001 only)

- On the synthesizer, zero the digital ALC calibration for the 0 dB attenuator setting for all frequency ranges:

**SERVICE** [Adjust Menu] [DigALC Menu]

[AtnStep To Cal] 0 dB

[Cal Freq Range Lo Band] [ALC Cal Array (Atn, Freq) Zero] (not applicable for all models)

[Cal Freq Range Hi Band] [ALC Cal Array (Atn, Freq) Zero]

### Note



The default values given in the next step are a general starting point. If the current ALC power accuracy is within 1 dB, fewer repetitions are required if you start with the existing calibration constants unchanged.

- Set the default values given in table 3-7 into the corresponding ALC calibration constants. On the synthesizer, set:

**SERVICE** [Adjust Menu] [Calib Menu]

[Select Cal] Enter the number of the calibration constant from table 3-7 and terminate the entry with **ENTER**.

[Modify Cal] Enter the default value from table 3-7 and terminate the entry with **ENTER**.

Table 3-7. ALC Calibration Constants and Default Values

ALC Calibration Constant	Default Value
<b>Low Band 0.01 to 2.4 GHz (not applicable for all models)</b>	
#265 LVL DAC Ofs Lo Bnd	150
#252 LVL DAC Gain Lo Bnd	0
#284 ALC Det Ofs; Lo	128
#293 ALC Log Brkpt; Lo	128
<b>High Band 2.3 to 20 GHz</b>	
#264 LVL DAC Ofs Hi Bnd	0
#251 LVL DAC Gain Hi Bnd	0
#283 ALC Det Ofs; Hi	128
#292 ALC Log Brkpt; Hi	128

- For instruments without low band, set A10R188 +20 DBM to the center of its adjustment range.

### Low Band ALC Power Accuracy Adjustment (not applicable for all models)

- On the synthesizer, set:

**CW** 1 GHz

**SERVICE** [Adjust Menu] [Calib Menu]

8. On the synthesizer, set:  
POWER LEVEL First power level in table 3-8
9. Select the first calibration constant in table 3-8:  
[Select Cal] 265 ENTER
10. On the synthesizer, select [Modify Cal] and, using the rotary knob, modify the calibration constant so that the power meter and the power level setting are the same.
11. Repeat steps 8 through 10 for each power level and calibration constant given in table 3-8.

*Table 3-8. Power Level and Calibration Constant Adjustment*

Power Level (dBm)	Calibration Constant Adjustment
0.0	#265 LVL DAC Ofs Lo Bnd
-10.0	#252 LVL DAC Gain Lo Bnd
-20.0	#284 ALC Det Ofs; Lo
+10.0	#293 ALC Det Log Brkpt; Lo

12. On the synthesizer, set:

POWER LEVEL 18 dBm

Adjust A10R125, +20 DBM, until the power meter and the power level setting are the same. Figure 3-28 shows the location of A10R125.

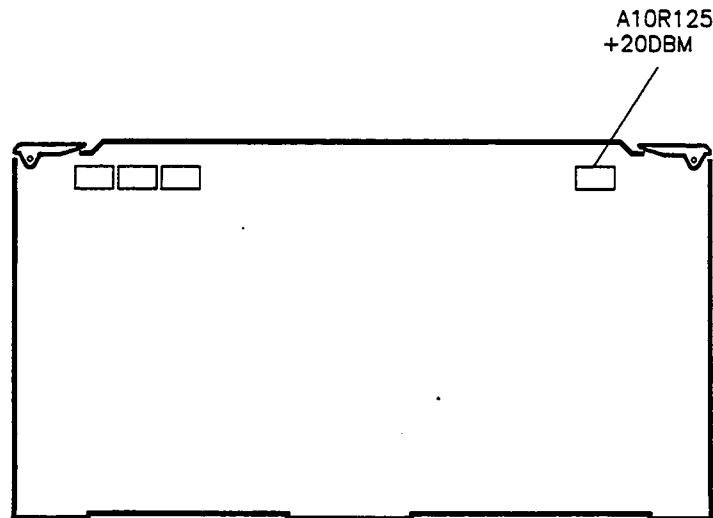

*Figure 3-28. A10R125 Location*



13. Repeat steps 8 through 12 until the power accuracy for each calibration constant is within  $\pm 0.01$  dBm.

### High Band Power Accuracy Adjustment

14. On the synthesizer, set:

**CW** **10** **GHz**

**SERVICE** [**Adjust Menu**] [**Calib Menu**]

15. On the power meter, set the CAL FACTOR % for the power sensor 10 GHz calibration factor.

16. On the synthesizer, set:

**POWER LEVEL** First power level in table 3-9

17. Select the first calibration constant in table 3-9:

[**Select Cal**] **264** **ENTER**

18. On the synthesizer, select [**Modify Cal**] and, using the rotary knob, modify the calibration constant so that the power meter and the power level setting are the same.

19. Repeat steps 16 through 18 for each power level and calibration constant given in table 3-9.

20. Repeat steps 16 through 19 until the power accuracy for each calibration constant is within  $\pm 0.01$  dBm.

*Table 3-9. Power Level and Calibration Constant Adjustment*

Power Level (dBm)	Calibration Constant Adjustment
0.0	#264 LVL DAC Ofc Hi Bnd
-10.0	#251 LVL DAC Gain Hi Bnd
-20.0	#283 ALC Det Ofc; Hi
+10.0	#292 ALC Det Log Brkpt; Hi

21. If this is the last calibration constant you will be adjusting, see "Calibration Constants" in this manual to store the calibration constants as protected data (in EEPROM).

### Related Performance Tests

Power Accuracy

### In Case of Difficulty

See "TROUBLESHOOTING" in the *Assembly-Level Repair* manual.

## 15. POWER FLATNESS

### Description and Procedure

In this procedure, the synthesizer measures and corrects power flatness. The synthesizer controls the power meter via HP-IB while the power meter is measuring the RF output. For each synthesizer frequency band and a 0 dB attenuator setting, control is given to the synthesizer to measure and correct power flatness.

### Note



This adjustment requires an HP 437B Power Meter. The correct power sensor calibration factors must be loaded and selected. This procedure cannot be run with a controller on the HP-IB, nor can it be run from a front panel emulator. For option 003 instruments, see "Automated Tests" in this manual.

1. Preset the instruments shown in figure 3-29. Do *not* connect the power sensor to the synthesizer RF OUTPUT yet. Let both instruments warm up for at least one hour.

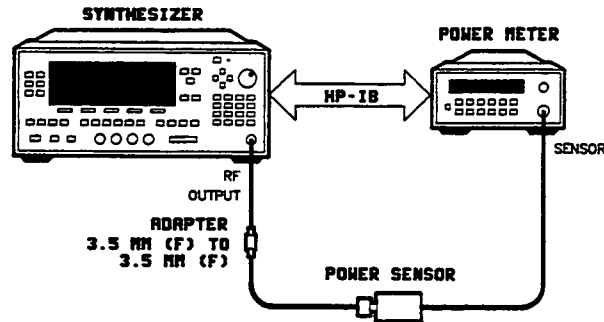

Figure 3-29. Power Flatness Adjustment Setup

### Low Band Power Flatness (not applicable for all models)

2. On the synthesizer, set:

**[SERVICE]** **[Adjust Menu]** **[DigALC Menu]**

**[Cal Freq Range Lo Bnd]** (asterisk on)

**[AtnStep to Cal]** **[0]** **[dB]**

3. Load and select the calibration factors for the correct power sensor for this frequency band into the power meter. Refer to the power meter manual for instructions.

Zero and calibrate the power meter then connect the power sensor to the synthesizer RF OUTPUT.

4. On the synthesizer, select **[Pwr Mtr ALC Cal]**.

The synthesizer measures power flatness and calculates a new flatness array for the frequency band and attenuator setting.

5. On the synthesizer, select **[SAVE]** and continue to the next step.

#### **High Band Power Flatness**

6. Load and select the calibration factors for the correct power sensor for this frequency band into the power meter. Refer to the power meter manual for instructions.

Zero and calibrate the power meter then connect the power sensor to the synthesizer RF OUTPUT.

7. On the synthesizer, set:  
**[Cal Freq Range Hi Band]** (asterisk on)
8. Repeat steps 3 through 5.

#### **Related Performance Tests**

Power Flatness

#### **In Case of Difficulty**

1. The HP 437B Power Meter must be used. Correct calibration factors must be loaded and selected.
2. Make sure that the only HP-IB connection is between the synthesizer and the power meter. No controller is allowed on the bus.
3. See "TROUBLESHOOTING" in the *Assembly-Level Repair* manual.

## 16. MODULATION GENERATOR ADJUSTMENT (OPTION 002)

### Description and Procedure

No test equipment is required for this procedure.

This procedure calibrates the modulation generator assembly by adjusting the AM and FM DACs. The internal DVM measures the DAC output voltages. The DAC offset is then zeroed with this adjustment procedure and the DAC gain is automatically calibrated with calibration constants.

1. Turn the synthesizer on and press **PRESET**. Let the instrument warm up for at least one hour.
2. Select the A8 adjustment menu. On the synthesizer, set:  
**SERVICE** **[Adjust Menu]** **[AssyAdj Menu]** **[A8 Adj Menu]**
3. The **[AM DAC]** adjustment is automatically selected (asterisk on).
4. Adjust A8R111 (see Figure 3-30 to center the "needle" on the display).

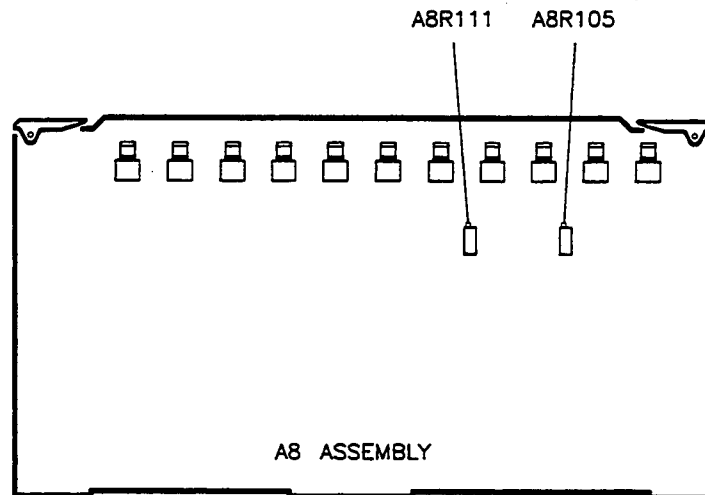

Figure 3-30. A8R111 and A8R105 Adjustment Locations

5. Select **[FM DAC]** (asterisk on).
6. Adjust A9R105 (see Figure 3-30) to center the "needle" on the display.

7. Select **[Done]**.

The synthesizer will display the following message:

Updating Cal Constants

8. If this is the last calibration constant you will be adjusting, see "Calibration Constants" to store the calibration constants as protected data (in EEPROM).

### **Related Performance Tests**

AM Accuracy

FM Accuracy

### **In Case of Difficulty**

See "Troubleshooting" in the *Assembly-Level Repair* manual.

## 17. AM ACCURACY

### Description and Procedure

This procedure consists of three adjustments. Calibration constant #277, AM Offset, is adjusted for no change in RF output power when AM is enabled but no voltage is applied. EXP AM CAL is adjusted for a  $-10$  dB change in power when  $-1.00$ V is applied and AM 10 dB/V is selected. LIN AM CAL is adjusted so that a  $-0.80$ V AM input (100 %/V AM selected) causes the RF output to decrease to 4.00% of its initial value.

1. Turn on the instruments shown in figure 3-31 and let them warm up for at least one hour.
2. Zero and calibrate the power meter/sensor.
3. Connect the equipment as shown in figure 3-31.

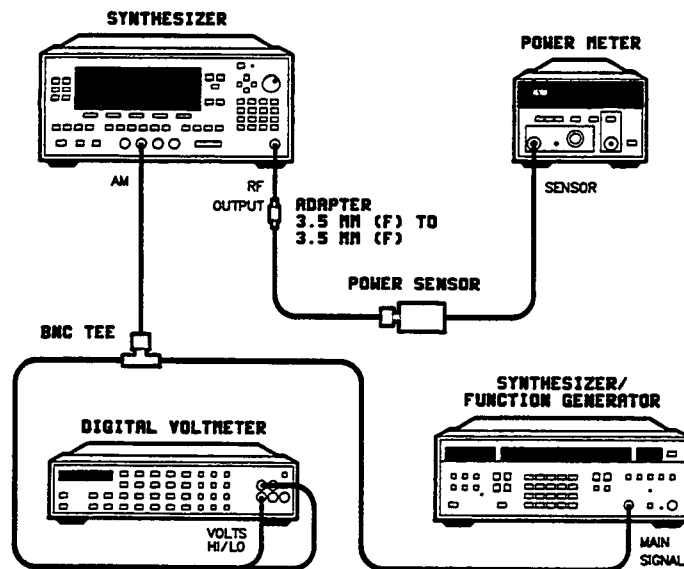

Figure 3-31. AM Accuracy Adjustment Setup

4. Set the function generator for a 0V dc rear panel output (the instrument front panel output is connected to the synthesizer's AM input.)

5. On the synthesizer, set:

**CW** **5** **GHz**

**POWER LEVEL** **-** **15** **dBm**

### AM Offset

6. Set the power meter to read relative power (dB).
7. On the synthesizer, set:  
**MOD** **[AM On/Off 100%/V]** (asterisk on)
8. Adjust calibration constant #277, AM Offset, for a 0 dB reading on the power meter. Set:  
**SERVICE** **[Adjust Menu]** **[Calib Menu]**  
**[Select Cal]** **277** **ENTER**  
**[Modify Cal]** Use the rotary knob to adjust the calibration constant for a 0 dB reading on the power meter.

### Log AM Accuracy

9. Set the power meter to measure absolute log power (dBm).
10. On the synthesizer, set:  
**POWER LEVEL** **0** **dBm**  
**MOD** **[AM On/Off 100%/V]** (asterisk off)
11. Set the function generator to the front panel output.
12. Set the power meter to read relative power (dB).
13. Set the function generator to  $-1.0V$  dc offset. Verify the correct voltage on the DVM.
14. On the synthesizer, set:  
**[AM On/Off 10dB/V]** (asterisk on)
15. Adjust A10R35, EXP AM CAL, for a  $-10$  dB power meter reading. See figure 3-32 for the location of A10R35.

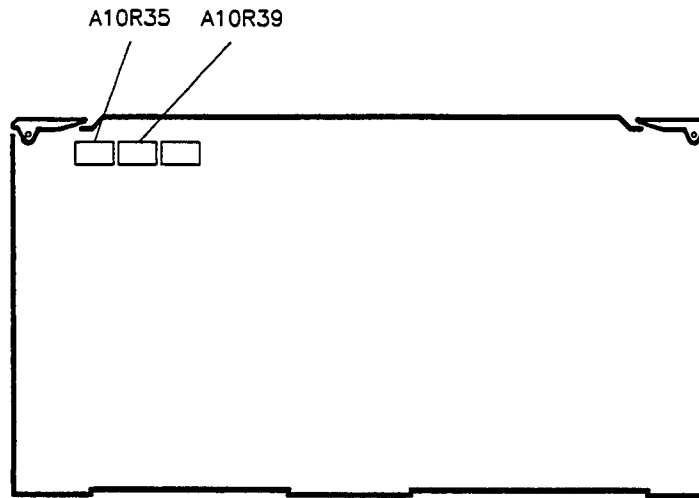

Figure 3-32. A10R35 and A10R39 Locations

### Linear AM Accuracy

16. On the synthesizer, set:

[AM On/Off 10dB/V] (asterisk off)

POWER LEVEL (5) dBm

17. Set the power meter to measure linear mode (watts).
18. For power meters without a relative linear mode, adjust the synthesizer power level for a 3.16 mW power meter reading.
- For power meters with relative linear mode (%), set the power meter to relative.
19. Set the function generator for a  $-0.8V$  dc offset. Verify the correct voltage on the DVM.
20. On the synthesizer, set:
- (MOD) [AM On/Off 100%/V] (asterisk on)
21. Adjust A10R39, LIN AM CAL, for a 0.126 mW (4.00% relative) reading. See figure 3-32 for the location of A10R39.

### Related Performance Tests

AM Accuracy

### In Case of Difficulty

See "TROUBLESHOOTING" in the *Assembly-Level Repair* manual.



## 18. AM DELAY

### Description and Procedure

In the ALC loop, the integrator input from the ALC detector is delayed (phase shifted from the reference input) through the ALC modulator, RF path, and ALC detector. Because of this, amplitude modulation can peak the AM frequency response. In this adjustment, you set the delay in the reference input equal to the delay in the input from the ALC detector.

The synthesizer is set to maximum leveled power at a CW frequency, with amplitude modulation at the maximum rate. Monitoring the INT LVL signal (the integrator output), adjust the AM DELAY to minimize any ac voltage present.

1. Preset the instruments shown in figure 3-33 and let them warm up for at least one hour.

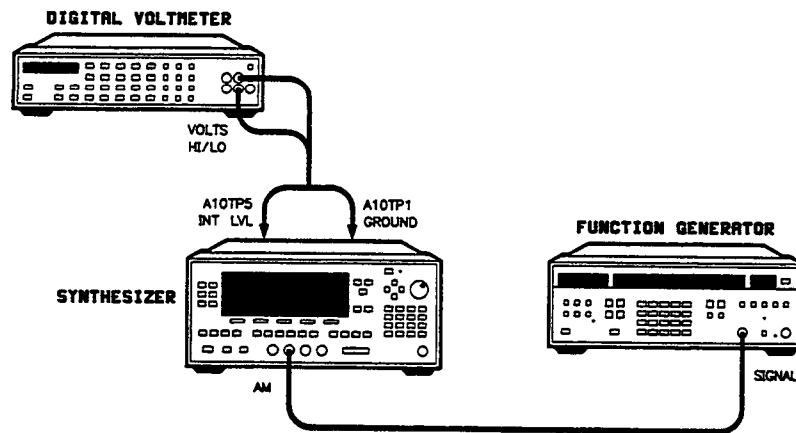

Figure 3-33. AM Delay Adjustment Setup

2. To achieve peak power, turn on RF peaking. Press:  
**USER CAL** [*Tracking Menu*] [*Peak RF Always*] (asterisk on)
3. Connect the equipment as shown in figure 3-33.
4. On the synthesizer, set:  
**CW** **10** **GHz**  
**POWER LEVEL** Set to 3 dB below maximum specified leveled power.  
**MOD** [*AM On/Off 100%V*] (asterisk on)

## Note



The function generator should have a  $50\Omega$  output for an accurate output. If necessary, use a BNC tee and monitor the output level while the function generator is connected to the AM input.

5. On the function generator, set:

Function: Sinewave  
Frequency: 100 kHz  
DC Offset: 0V  
Output: Front panel  
Amplitude 600 mV p-p

6. Adjust A10R55 (see figure 3-34) for a minimum ac voltage reading on the DVM.

## Note



You should expect to see very small changes in voltage.

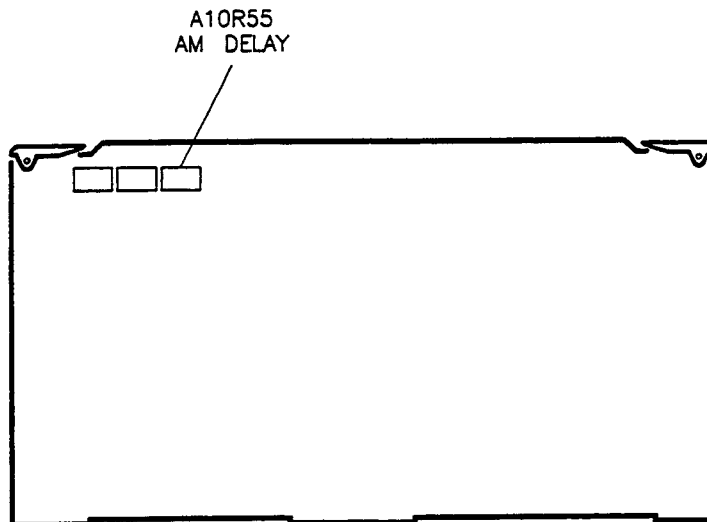

Figure 3-34. AM Delay Adjustment Location

## Related Performance Tests

AM Bandwidth

## In Case of Difficulty

See "TROUBLESHOOTING" in the *Assembly-Level Repair* manual.

## 19. PULSE DELAY

### Description and Procedure

In this procedure the rising edges of the pulsed input and the amplifier/detector output are aligned to ensure an output to the SRD bias generator during the pulse.

The synthesizer is set up for external pulse modulation at its narrowest width. A9R76 is set fully counter-clockwise for maximum delay of the pulsed input. As the potentiometer is adjusted clockwise, the pulse is shifted. The integrated dc output of the pulsed input and the amplifier/detector output is monitored. The dc level reaches maximum where the two signals are aligned. The rising edges of the two signals align just before the dc level starts to decrease from the maximum level.

### Caution



A voltage more negative than  $-0.5V$  on the PULSE input connector will damage the synthesizer.

1. Preset the equipment shown in figure 3-35 and let them warm up for at least one hour.

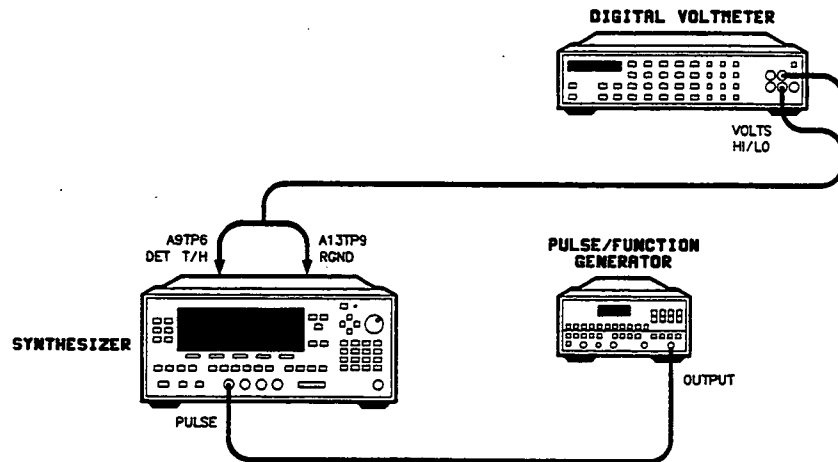

Figure 3-35. Pulse Delay Adjustment Setup

2. To achieve peak power, turn on RF peaking. Press:  
**USER CAL** [**Tracking Menu**] [**Peak RF Always**] (asterisk on)
3. Connect the equipment as shown in figure 3-35.

4. On the synthesizer, set:

**CW** **5** **GHz**

**POWER LEVEL** Set to maximum specified leveled power.

**ALC** [**Leveling Mode Search**] (asterisk on)

**MOD** [**Pulse On/Off External**] (asterisk on)

5. On the pulse generator, set:

Pulse Width: 100 ns

Pulse Period: 1  $\mu$ s

Pulse Amplitude: 0 to +5V

6. Preset A9R76 (see figure 3-36) fully counter-clockwise.

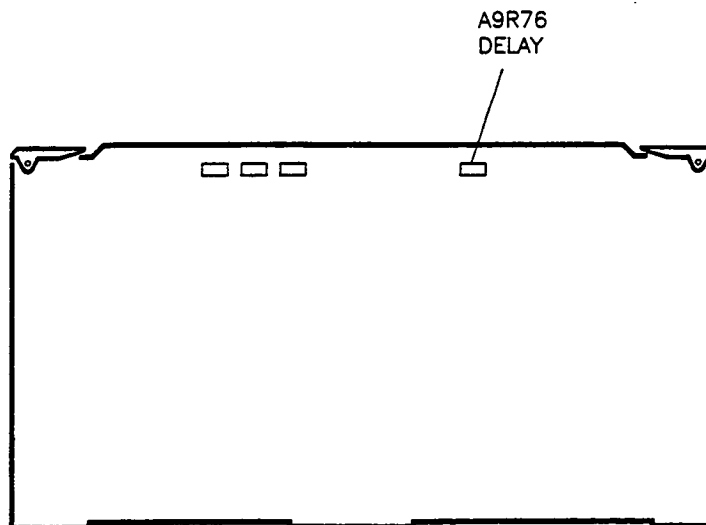

**Figure 3-36. Pulse Delay Adjustment Location**

7. Note the voltage reading on the DVM: \_\_\_\_\_
8. Adjust A9R76 clockwise just until the voltage starts to drop. Set the adjustment slightly counter-clockwise from the point at which the voltage starts to drop.

## **Performance Tests**

Pulse Performance

### **In Case of Difficulty**

1. Make sure the pulse input has sufficient amplitude to pulse the RF.
2. See "TROUBLESHOOTING" in the *Assembly-Level Repair* manual.

## 20. FM GAIN

### Description and Procedure

This adjustment sets the gain on the FM driver assembly to match the YO FM coil sensitivity, and to provide a 10 MHz/V FM input sensitivity. The function generator is set to provide FM at a 1 MHz rate and a 2.404 MHz deviation. This corresponds to a modulation index of 2.404, which should result in no power in the carrier. FM gain is adjusted to minimize the RF output power.

1. Connect the equipment as shown in figure 3-37. Preset all instruments and let them warm up for at least one hour.

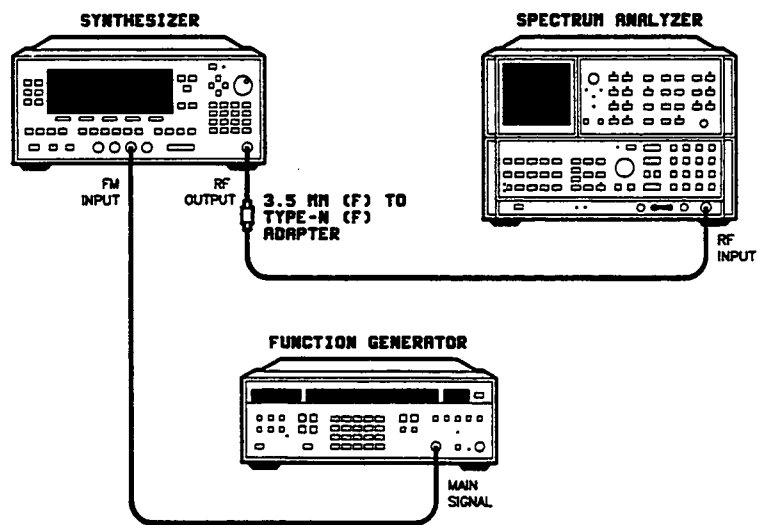

Figure 3-37. FM Gain Adjustment Setup

### Note



The function generator specified in "EQUIPMENT REQUIRED" is accurate enough to set the amplitude without using a DVM. If you use a different function generator, use a wide bandwidth DVM, such as an HP 3458A, to accurately set the voltage.

2. On the function generator, set:

Function: Sinewave  
Frequency: 1 MHz  
DC Offset: 0V  
Amplitude: 480.8 mVp-p (169.96 mV rms)

3. On the spectrum analyzer, set:

Reference Level: 0 dBm  
Attenuator: Auto  
Center Frequency: 5 GHz  
Frequency Span: 50 kHz  
Resolution BW: 3 kHz  
Video BW: 1 kHz  
Sweep Time: Auto  
Sweep: Continuous

4. On the synthesizer, set:

**CW** **5** **GHz**

**MOD** **[FM On/Off AC]** **10 MHz/V** (asterisk on)

5. Adjust A11R55 (see figure 3-38) for a minimum amplitude signal on the spectrum analyzer.

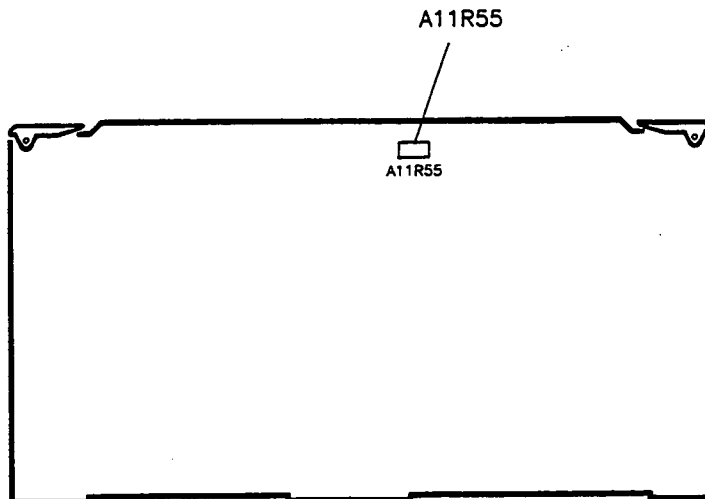

Figure 3-38. FM Gain Adjustment Location

## **Performance Tests**

Self-tests  
FM Accuracy

### **In Case of Difficulty**

1. Verify the function generator output (amplitude and frequency) with an oscilloscope. Use a BNC tee with the function generator connected to the FM input.
2. See "TROUBLESHOOTING" in the *Assembly-Level Repair* manual.



## 21. SQUARE WAVE SYMMETRY

### Description and Procedure

Use this adjustment to set the synthesizer modulation (27.78 square wave) for equal RF on/off periods. Using a power meter, adjust calibration constants for an RF output power decrease of 3 dB when the synthesizer square wave is on.

### Note



If you are not familiar with how to adjust calibration constants, refer to the "Calibration Constants" section of this chapter.

1. Turn on the equipment shown in figure 3-39 and let them warm up for at least one hour.

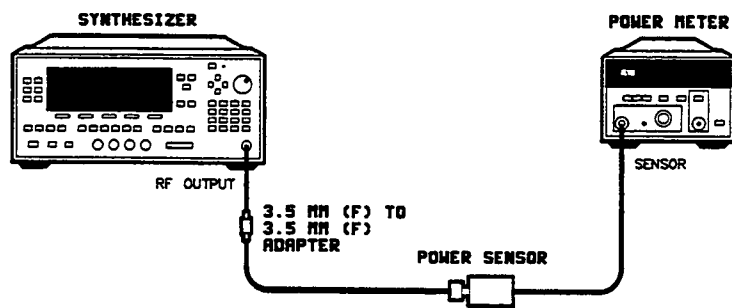

Figure 3-39. Square Wave Symmetry Adjustment Setup

2. On the power meter:  
Zero and calibrate the power meter/power sensor.
3. Connect the equipment as shown in figure 3-39 and preset the instruments.
4. On the synthesizer, set:  
**CW** **10** **GHz**  
**POWER LEVEL** **0** **dBm**
5. Set the power meter for a relative measurement (dB).

6. On the synthesizer, set:

**MOD** [**Pulse On/Off Scalar**] (asterisk on)

Adjust calibration constant #330 (Slow Sym High Band) for a  $-3.0$  dB reading on the power meter. Press:

**SERVICE** [**Adjust Menu**] [**Calib Menu**] [**Select Cal**]

Use the rotary knob or arrow keys to select calibration constant #330. Select [**Modify Cal**] and use the rotary knob to adjust the calibration constant.

On the synthesizer, set:

**MOD** [**Pulse On/Off Scalar**] (asterisk off)

**CW** **1** **GHz**

7. On the power meter, set:

Absolute power mode (dBm) (to measure the power level at 1 GHz).

Relative measurement mode (dB).

8. On the synthesizer, set:

**MOD** [**Pulse On/Off Scalar**] (asterisk on)

Adjust calibration constant #329 (Slow Sym Low Band) for a  $-3$  dB reading on the power meter. Press:

**SERVICE** [**Adjust Menu**] [**Calib Menu**] [**Select Cal**]

Use the rotary knob or arrow keys to select calibration constant #329. Select [**Modify Cal**] and use the rotary knob to adjust the calibration constant.

9. If this is the last calibration constant you will be adjusting see "Calibration Constants" to store the calibration constants as protected data (in EEPROM).

## Related Performance Tests

Self-tests

Pulse On/Off Ratio

Pulse Performance

## In Case of Difficulty

See "TROUBLESHOOTING" in the *Assembly-Level Repair* manual.

## 22. AM INPUT IMPEDANCE

### Description and Procedure

No test equipment is required for this procedure.

This procedure sets the AM input impedance to either 50Ω or 2 kΩ. The AM input impedance on A10 must be set to 2 kΩ for proper operation of the internal modulation generator (Option 002).

Instruments without Option 002 should perform step A, "A10 Jumper".

Instruments with Option 002 should set the A10 jumper to the 2 kΩ position using step A, "A10 Jumper" and should perform step B, "A8 Jumper."

### A. A10 Jumper

1. On the synthesizer, set the line power switch to standby.
2. Lift up the A10 ALC assembly far enough to access the jumper shown in Figure 3-40.
3. The AM input impedance is factory-set to the 50 ohm position. To change it to 2 kohms, move the jumper to the position marked "2K". The jumper can be returned to the "50 ohm" position to change the AM input impedance to 50 ohms.
4. Reinstall the A10 assembly.

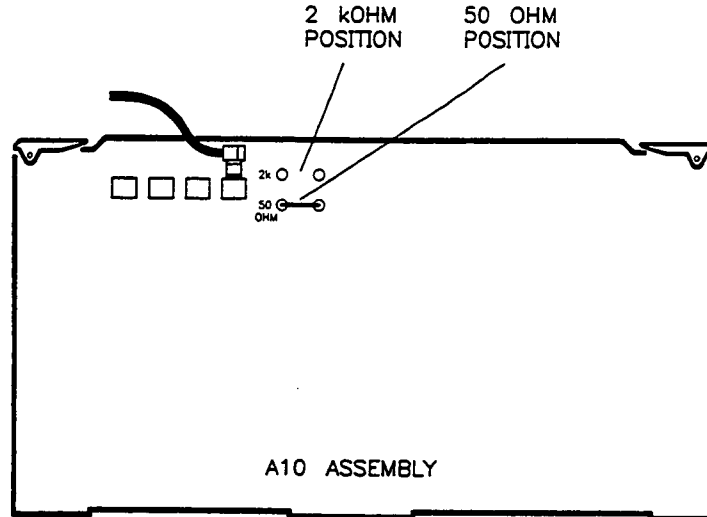

Figure 3-40. A10 Jumper Locations

## B. A8 Jumper

1. On the synthesizer, make sure the line power switch is set to standby.
2. Lift up the A8 modulator generator assembly far enough to access the jumper shown in Figure 3-41.
3. The AM input impedance is factory-set to the 50 ohm position. To change it to 2 kohms, move the jumper to the position marked "2K". The jumper can be returned to the position marked "50" to change the AM input impedance to 50 ohms.
4. Reinstall the A8 assembly.

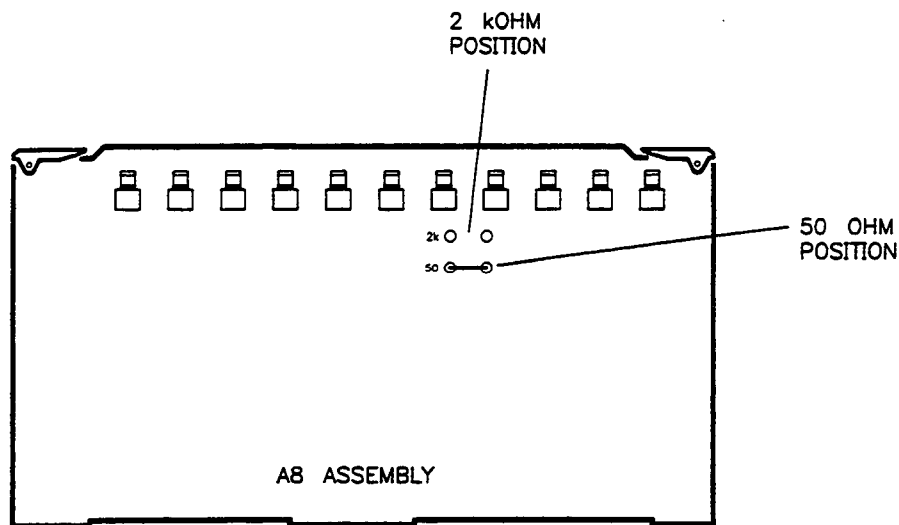

Figure 3-41. A8 Jumper Locations

## Related Performance Tests

AM Accuracy  
AM Bandwidth  
AM Dynamic Range

## In Case of Difficulty

If the jumper is missing, see "Replaceable Parts".

## 23. FM INPUT IMPEDANCE

### Description and Procedure

A soldering iron is required for this procedure.

This procedure sets the FM input impedance to either 50Ω or 600Ω. The FM input impedance on A11 must be set to 600Ω for proper operation of the internal modulation generator (Option 002).

Instruments without Option 002 should perform step A, "A11 Jumper".

Instruments with Option 002 should set the A11 jumper to the 600Ω position using step A, "A11 Jumper" and should perform step B, "A8 Jumper."

### A. A11 Jumper

1. On the synthesizer, set the line power switch to standby.
2. Disconnect the coaxial cables from the A11 FM driver assembly.
3. Remove the A11 assembly from the synthesizer.
4. Locate the zero ohm resistor shown in Figure 3-42. The FM input impedance is factory-set to the 50 ohm position. To change it to 600 ohms, remove the resistor from the A11 assembly by unsoldering it. The FM input impedance can be reset to 50 ohms by soldering the resistor back into the A11 assembly.

### Note



If you will never use the 50 ohm setting, the resistor can be clipped out.

5. Reinstall the A11 assembly and reconnect the coaxial cables.

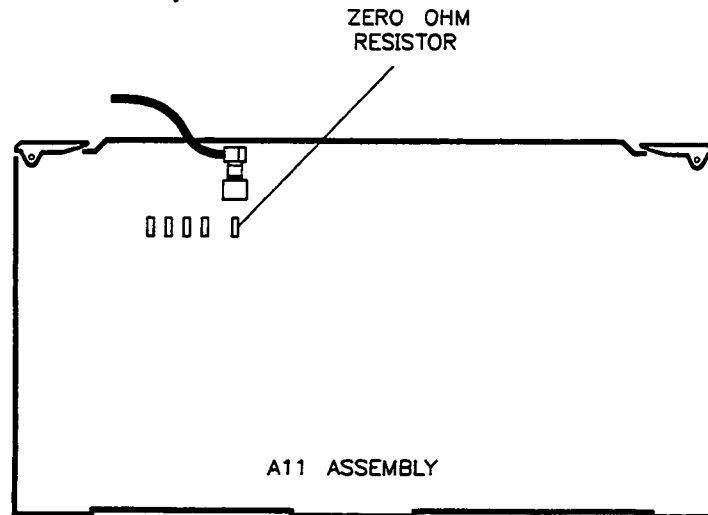

Figure 3-42. FM Input Impedance Jumper Locations

## B. A8 Jumper

1. On the synthesizer, make sure the line power switch is set to standby.
2. Lift up the A8 modulator generator assembly far enough to access the jumper shown in Figure 3-43.
3. The FM input impedance is factory-set to the 50 ohm position. To change it to 600 ohms, move the jumper to the position marked "600". The jumper can be returned to the position marked "50" to change the FM input impedance to 50 ohms.
4. Reinstall the A8 assembly.

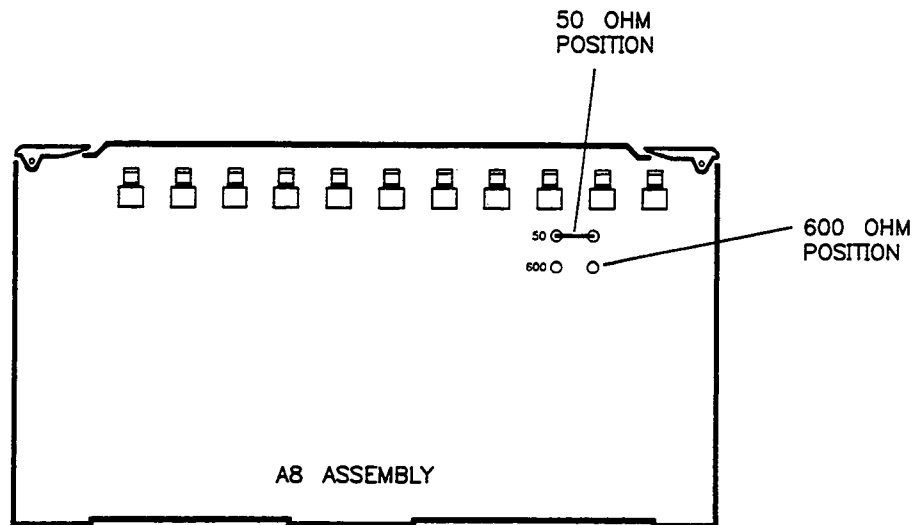

Figure 3-43. A8 Jumper Locations

## Related Performance Tests

FM Accuracy  
FM Bandwidth  
Maximum FM Deviation

## In Case of Difficulty

If the jumper is missing, see "Replaceable Parts".

## 24. MODULATION GENERATOR FLATNESS ADJUSTMENT (OPTION 002)

### Description and Procedure

The internal modulation generator is set up for FM operation. A 100 kHz rate, measured at the AM/FM OUTPUT connector, is used as the reference amplitude. A calibration constant is adjusted so the AM/FM output signal is the same amplitude as for a 1 MHz FM rate.

1. Connect the equipment as shown in Figure 3-44. Preset all instruments and let them warm up for at least one hour.

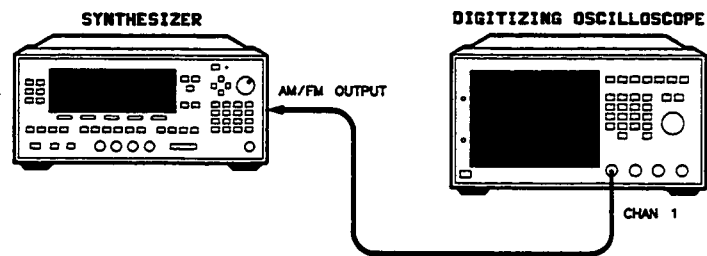

Figure 3-44. Modulation Generator Flatness Adjustment Setup

2. On the synthesizer, set:  
[MOD] [FM MENU] [FM On/Off Int] (asterisk on)  
[Internal FM Rate] 100 kHz [Internal FM Dev] 8 MHz  
[PRIOR] [Monitor Menu] [ModOut On/Off FM]

3. On the oscilloscope, set:

Channel 1:

Display	On
Volts/Division	210 mV
Input Coupling	dc
Input Impedance	50Ω

TIMEBASE:

Time/Division	2 μs
Delay Reference	center
Sweep	auto

TRIGGER:

Trigger Mode	Edge
Trig Src	Chan 1
Slope	Pos

DISPLAY:

Display Mode	Repetitive
Averaging	Off
Display Time	0.2 s

4. Adjust the oscilloscope vertical sensitivity controls to almost fill the graticule display with the sine wave. Do not let the sinewave be clipped. (Use the front panel keypad because the RPG changes the sensitivity in steps too large for this purpose.)
5. Use the measure feature of the oscilloscope to measure the amplitude of the sinewave. (If a **Signal clipped** message is displayed, repeat the vertical sensitivity adjustment until the message is no longer displayed when the signal is measured.) Record the amplitude of the sinewave \_\_\_\_\_ V p-p.
6. On the oscilloscope, change the timebase to 200 ns/div.

7. On the synthesizer, set:

**FM Menu** [**Internal FM Rate**] **1** **MHz**

**SERVICE** [**Adjust Menu**] [**Calib Menu**] [**Select Cal**] **274** **ENTER**

8. Select [**Modify Cal**] and, using the rotary knob, change the calibration constant until the sinewave displayed on the oscilloscope is the same amplitude (V p-p) as the recorded value. (The oscilloscope does not automatically update the measurement; continue to press the measure function as you change the calibration constant.)
9. If this is the last calibration constant you will be adjusting, see "Calibration Constants" to store the calibration constants as protected data (in EEPROM).



## **Related Performance Tests**

FM Accuracy

## **In Case of Difficulty**

See "Troubleshooting" in the *Assembly-Level Repair* manual.

## Calibration Constants

## Calibration Constants

---

### Introduction

This section contains the following information on calibration constants and how to use them:

- Definition.
- Memory Areas.
- Checksum Verification.
- Calibration Constant Password.
- Changing Working Data Calibration Constants.
- Saving Working Data Calibration Constants.
- Loading Protected Data Calibration Constants.
- Loading Default Data Calibration Constants.
- Calibration Constant Descriptions.

---

### Definition

Calibration constants are data which describe your individual instrument. Calibration constants contain serial number prefix, hardware configuration, and board revision information. Calibration constants also contain calibration information specific to the operation of each instrument that is used to make sure that the instrument meets specifications.

**Note:** Changing calibration constants can cause your instrument to *not* meet specifications.

---

## Memory Areas

The synthesizer has three memory areas reserved for calibration constants:

### Working Data

Working data is the set of calibration constants accessed during normal operation and contains the calibration information required for optimum instrument performance. Working data is stored in RAM, and is maintained by a 1 farad capacitor.

### Protected Data

Protected data resides in EEPROM. This calibration data is essentially the same as working data, but is not dependent on the capacitor. If the synthesizer's checksum test fails, or if the capacitor becomes discharged and working data is lost, the synthesizer copies protected data values into working data RAM.

**Note:** If the synthesizer is unplugged for a period greater than five days, the capacitor will be completely discharged. After reconnecting the synthesizer to line power, the capacitor will be completely recharged after 24 hours.

### Default Data

Default data resides in UVEPROM. This data differs from working and protected data in that it cannot be changed. This data represents a typical synthesizer, and is not optimized for your instrument. The default calibration constants are a starting point for calibration. The synthesizer will probably *not* meet specifications. The synthesizer uses default data if a problem exists in both working and protected data or if you select **Default Cal** in the calibration utility menu.

---

## Checksum Verification

At instrument power on, the calibration constants stored in RAM are added and compared with the checksum value. If the two values match, the current calibration constants are maintained in RAM.

If the RAM checksum does not verify, the calibration constants are loaded into RAM from EEPROM. These calibration constants are added and compared with their checksum value. If the two values match, these calibration constants (from EEPROM) are maintained in RAM.

If the RAM checksum still does not verify, the default calibration constants are loaded into RAM from UVEEPROM. A message is displayed on the synthesizer indicating that the default calibration constants are in use. The synthesizer will probably *not* meet performance specifications. All the performance tests should be run.

---

## Calibration Constant Password

The synthesizer is shipped with a factory-set password. A password disables access to the adjustment menu unless the password is entered (see “Entering a Password”). Calibration constants *cannot* be manually altered without accessing the adjustment menu.

The following is the factory-set password: 8360

You can set a new password. See “Setting a Password”.

You can eliminate the password. See “Disabling a Password”.

If you have forgotten the password, or if you require access to the calibration constant adjustments for calibration purposes and do not know the password, see “Bypassing the Password”.

## Entering a Password

An asterisk on the **Disable Adjust** softkey in the service menu indicates that a password is set. In order to access the adjustment menu you must enter that password:

1. On the synthesizer, set:  
**SERVICE Adjust Menu**.

The following message is displayed: ENTER PASSWORD: \*

2. Enter the correct password using the numeric keypad and press **ENTER**.

The asterisk on the **Disable Adjust** softkey turns off.

3. Select **Adjust Menu** again to access the adjustment menu.

Entering the password allows permanent access to the adjustment menu, even if line power is cycled. To disable access again, set another password.

## Disabling a Password

If you wish to eliminate a password (either the factory-set password or one you set yourself), perform the following:

1. On the synthesizer, set:  
**SERVICE Disable Adjust**.

The following message is displayed: ENTER PASSWORD: \*

2. Enter the current password using the numeric keypad and press **ENTER**.

The asterisk on the **Disable Adjust** softkey turns off.

Disabling the password allows permanent access to the adjustment menu, even if line power is cycled.

## Setting a Password

If a password is already set on the synthesizer and you wish to change it, first follow the “Disabling a Password” procedure. This eliminates the current password. Then continue with this procedure.

If no password is set on the synthesizer (there is no asterisk on the **Disable Adjust** softkey), and you wish to set a password, perform the following:

1. On the synthesizer, set:

**SERVICE** **Disable Adjust**.

The following message is displayed: SET PASSWORD: 0

2. Enter the desired password using the numeric keypad. Up to 14 numeric digits are allowed. Terminate the entry by pressing: **ENTER**.
3. A warning message is displayed informing you that the adjustment menus will no longer be accessible. To verify that you do wish to set the password, select **Yes, Confirm**.

The asterisk on the **Disable Adjust** softkey turns on, indicating the password is set.

## Bypassing the Password

If you require access to the adjustment menu for calibration purposes, a password is set, and you do not know the password, perform the following:

1. Turn off line power to the synthesizer.
2. Open A15S1 switch 5 (set the switch to the "1" position).
3. Turn on line power to the synthesizer and press **SERVICE**.

The asterisk on the **Disable Adjust** softkey turns off enabling access to the adjustment menu.

When access to the adjustment menu is no longer desired, enable the previously set password. Perform the following:

4. Turn off line power to the synthesizer.

5. Close A15S1 switch 5 (set the switch to the "0" position).
6. Turn on line power to the synthesizer and press **SERVICE**.

The asterisk on the **Disable Adjust** softkey turns on indicating that you cannot access the adjustment menu.

If you have forgotten the password and wish to set a new one, perform steps 1 through 3 and then steps 7 through 10.

7. On the synthesizer, select **Disable Adjust**.

The following message is displayed: SET PASSWORD: 0

8. Enter the desired password using the numeric keypad. Up to 14 numeric digits are allowed. Terminate the entry by pressing: **ENTER**.
9. A warning message is displayed informing you that the adjustment menus will no longer be accessible. To verify that you do wish to set the password, select **Yes, Confirm**.
10. Another warning message is displayed informing you that the A15S1 switch 5 is set open. Complete steps 4 through 6 to close the switch and enable the password.

---

## Changing Working Data Calibration Constants

If you need to modify the working data calibration constants, the following procedure accesses the calibration constants and lets you change them.

1. On the synthesizer, set:  
**SERVICE** **Adjust Menu** **Calib Menu**.

2. Select **Select Cal**.

Enter the number of the calibration constant you wish to change using the up/down arrow keys, the rotary knob, or the numeric keypad. Terminate numeric keypad entries by pressing **ENTER**.

3. Select **Modify Cal**.



Change the value of the calibration constant using the right/left arrow keys, the rotary knob, or the numeric keypad. Terminate numeric keypad entries by pressing **ENTER**.

4. Exit the calibration menu using the **PRIOR** key or by pressing **PRESET**.

---

## Saving Working Data Calibration Constants

In some adjustment procedures you will change working data calibration constants. The following procedure stores the calibration constants as protected data (in EEPROM).

1. On the synthesizer, set:  
**SERVICE** **Adjust Menu** **Calib Menu** **Cal Util Menu**.
2. Select **Save Cal**.

A warning is displayed informing you that changing the calibration constants may drastically affect instrument performance. To verify that you do wish to save the new calibration constants, select **yes**.

The working data calibration constants are now stored as protected data (in EEPROM).

3. Exit the calibration utility menu using the **PRIOR** key or pressing **PRESET**.

---

## Loading Protected Data Calibration Constants

If your working data calibration constants have been altered or deleted, the following procedure loads the protected calibration constants from EEPROM into working data memory.

1. On the synthesizer, set: **SERVICE** **Adjust Menu** **Calib Menu**  
**Cal Util Menu**.
2. Select **Recall Cal**.

A warning is displayed informing you that changing the calibration constants may drastically affect instrument performance. To verify that you do wish to recall the protected data calibration constants, select **yes**.

The protected data calibration constants are now loaded into working data.

3. Exit the calibration utility menu using the **(PRIOR)** key or pressing **(PRESET)**.

---

## Loading Default Data Calibration Constants

If you want to use the generic synthesizer calibration constants as working data, the following procedure loads the default calibration constants from UVEPROM into working data memory.

1. On the synthesizer, set:  
**(SERVICE) Adjust Menu Calib Menu Cal Util Menu**.
2. Select **Default1 Cal**.

A warning is displayed informing you that changing the calibration constants may drastically affect instrument performance. To verify that you do wish to recall the default calibration constants, select **yes**.

The default data calibration constants are now loaded into working data.

3. Exit the calibration utility menu using the **(PRIOR)** key or pressing **(PRESET)**.

---

## Calibration Constant Descriptions

Table 3-9 provides the following information for each calibration constant:

- The calibration constant number in ascending order.
- The calibration constant name. An asterisk indicates that this calibration constant is adjusted by an automated adjustment.
- The range of realistic adjustment (adjustment outside of the range may be possible but will probably cause the synthesizer to be severely misadjusted)

or the default value (some calibration constants are set to a default value and are not adjustable).

- The related adjustment procedure, manual, automated, or front panel, that adjusts that calibration constant.

**Note:** Blank calibration constants are reserved for future use.

**Table 3-9. Calibration Constant Descriptions**

Number	Description	Range or Default	Related Adjustment
1	Identifier Response	0 — HP 83620A 1 — HP 83621A 2 — HP 83622A 3 — HP 83623A 4 — HP 83624A 5 — HP 83640A 6 — HP 83642A 7 — HP 8340B 8 — HP 83631A 9 — HP 8341B 10 — HP 83650A 11 — HP 83651A 12 — Not Used 13 — HP 83630A	
2	Dwell After RF On	2	
3	User Configuration	0	
4	Lockout Features	0	
5	Display Field Lock	0	
6	Retrace Dwell Time	0	
7			
8			
9			
10			
11			
12			
13			
14			
15			
16	Production Info 1	0	
17	Production Info 2	0	
18	Production Info 3	Instrument specific	
19	Production Info 4	Instrument specific	
20	Production Info 5	Instrument specific	
21	Lock Dwell Time	2	
22	Max Ph Lk Wait	100	

**Table 3-9. Calibration Constant Descriptions (continued)**

Number	Description	Range or Default	Related Adjustment
23	YO Slew Rate	500	
24	YO Kick Max	6000	
25	YO Settle Rate	20	
26			
27			
28			
29			
30			
31			
32			
33			
34			
35			
36	YO Dly Term A Bnd 0	400 to 800	YO Delay Adjustment
37	YO Dly Term A Bnd 1	400 to 800	YO Delay Adjustment
38	YO Dly Term A Bnd 2	400 to 800	YO Delay Adjustment
39	YO Dly Term A Bnd 3	400 to 800	YO Delay Adjustment
40	YO Dly Term A Bnd 4	400 to 800	YO Delay Adjustment
41	YO Dly Term A Bnd 5	400 to 800	YO Delay Adjustment
42	YO Dly Term A Bnd 6	400 to 800	YO Delay Adjustment
43	YO Dly Term A Bnd 7	400 to 800	YO Delay Adjustment
44			
45			
46			
47			
48			
49			
50	YO Dly Term B Bnd 0	300 to 700	YO Delay Adjustment
51	YO Dly Term B Bnd 1	300 to 700	YO Delay Adjustment
52	YO Dly Term B Bnd 2	300 to 700	YO Delay Adjustment
53	YO Dly Term B Bnd 3	300 to 700	YO Delay Adjustment
54	YO Dly Term B Bnd 4	300 to 700	YO Delay Adjustment

**Table 3-9. Calibration Constant Descriptions (continued)**

Number	Description	Range or Default	Related Adjustment
55	YO Dly Term B Bnd 5	300 to 700	YO Delay Adjustment
56	YO Dly Term B Bnd 6	300 to 700	YO Delay Adjustment
57	YO Dly Term B Bnd 7	300 to 700	YO Delay Adjustment
58			
59			
60			
61			
62			
63			
64			
65			
66			
67			
68			
69			
70			
71			
72	*CW Offset	-500 to +500	YO Driver Gain And Linearity
73	YO Off Ver; Band 0	0	
74	YO Off Ver; Band 1	0	
75	YO Off Ver; Band 2	0	
76	YO Off Ver; Band 3	0	
77	YO Off Ver; Band 4	0	
78	YO Off Ver; Band 5	0	
79	YO Off Ver; Band 6	0	
80	YO Off Ver; Band 7	0	
81			
82			
83			
84			
85			
86			

**Table 3-9. Calibration Constant Descriptions (continued)**

<b>Number</b>	<b>Description</b>	<b>Range or Default</b>	<b>Related Adjustment</b>
87	YO Swp Ver; Band 0	0	
88	YO Swp Ver; Band 1	0	
89	YO Swp Ver; Band 2	0	
90	YO Swp Ver; Band 3	0	
91	YO Swp Ver; Band 4	0	
92	YO Swp Ver; Band 5	0	
93	YO Swp Ver; Band 6	0	
94	YO Swp Ver; Band 7	0	
95			
96			
97			
98			
99			
100			
101	YTM Temp Coefficient	0	
102			
103			
104			
105	SRD Bias A; Band 1	30 to 230	Amp/Multiplier Adjustments
106	SRD Bias A; Band 2	30 to 230	Amp/Multiplier Adjustments
107	SRD Bias A; Band 3	30 to 230	Amp/Multiplier Adjustments
108	SRD Bias A; Band 4	30 to 230	Amp/Multiplier Adjustments
109	SRD Bias A; Band 5	30 to 230	Amp/Multiplier Adjustments
110	SRD Bias A; Band 6	30 to 230	Amp/Multiplier Adjustments
111	SRD Bias A; Band 7	30 to 230	Amp/Multiplier Adjustments
112			
113			
114			
115			
116			
117			

**Table 3-9. Calibration Constant Descriptions (continued)**

Number	Description	Range or Default	Related Adjustment
118	SRD Bias B; Band 1	30 to 230	Amp/Multiplier Adjustments
119	SRD Bias B; Band 2	30 to 230	Amp/Multiplier Adjustments
120	SRD Bias B; Band 3	30 to 230	Amp/Multiplier Adjustments
121	SRD Bias B; Band 4	30 to 230	Amp/Multiplier Adjustments
122	SRD Bias B; Band 5	30 to 230	Amp/Multiplier Adjustments
123	SRD Bias B; Band 6	30 to 230	Amp/Multiplier Adjustments
124	SRD Bias B; Band 7	30 to 230	Amp/Multiplier Adjustments
125			
126			
127			
128			
129			
130			
131	Squegg Clamp 1A	40 to 200	Amplifier/Filter Adjustments
132	Squegg Clamp 2A	50 to 255	Amplifier/Filter Adjustments
133	Squegg Clamp 3A	50 to 255	Amplifier/Filter Adjustments
134	Squegg Clamp 4A	50 to 255	Amplifier/Filter Adjustments
135	Squegg Clamp 5A	50 to 255	Amplifier/Filter Adjustments
136	Squegg Clamp 6A	50 to 255	Amplifier/Filter Adjustments
137	Squegg Clamp 7A	50 to 255	Amplifier/Filter Adjustments
138			
139			
140			
141			
142			
143			
144	YTM Dly Term A Hrm 1	600 to 2000	Amplifier/Filter Adjustments
145	YTM Dly Term A Hrm 2	600 to 2500	Amplifier/Filter Adjustments
146	YTM Dly Term A Hrm 3	600 to 3000	Amplifier/Filter Adjustments
147	YTM Dly Term A Hrm 4	600 to 2500	Amplifier/Filter Adjustments
148	YTM Dly Term A Hrm 5	600 to 3000	Amplifier/Filter Adjustments
149	YTM Dly Term A Hrm 6	600 to 3000	Amplifier/Filter Adjustments
150	YTM Dly Term A Hrm 7	600 to 3000	Amplifier/Filter Adjustments



**Table 3-9. Calibration Constant Descriptions (continued)**

Number	Description	Range or Default	Related Adjustment
151			
152			
153			
154			
155			
156			
157	YTM Dly Term B Hrm 1	200 to 500	Amplifier/Filter Adjustments
158	YTM Dly Term B Hrm 2	200 to 500	Amplifier/Filter Adjustments
159	YTM Dly Term B Hrm 3	200 to 500	Amplifier/Filter Adjustments
160	YTM Dly Term B Hrm 4	200 to 500	Amplifier/Filter Adjustments
161	YTM Dly Term B Hrm 5	200 to 500	Amplifier/Filter Adjustments
162	YTM Dly Term B Hrm 6	200 to 500	Amplifier/Filter Adjustments
163	YTM Dly Term B Hrm 7	200 to 500	Amplifier/Filter Adjustments
164			
165			
166			
167			
168			
169			
170	YTM Bx Dly Term A 1	600 to 2000	Amp/Multiplier Adjustments
171	YTM Bx Dly Term A 2	600 to 2500	Amp/Multiplier Adjustments
172	YTM Bx Dly Term A 3	600 to 3000	Amp/Multiplier Adjustments
173	YTM Bx Dly Term A 4	600 to 2500	Amp/Multiplier Adjustments
174	YTM Bx Dly Term A 5	600 to 3000	Amp/Multiplier Adjustments
175	YTM Bx Dly Term A 6	600 to 3000	Amp/Multiplier Adjustments
176	YTM Bx Dly Term A 7	600 to 3000	Amp/Multiplier Adjustments
177			
178			
179			
180			
181			
182			

**Table 3-9. Calibration Constant Descriptions (continued)**

Number	Description	Range or Default	Related Adjustment
183	YTM Bx Dly Term B 1	200 to 500	Amp/Multiplier Adjustments
184	YTM Bx Dly Term B 2	200 to 500	Amp/Multiplier Adjustments
185	YTM Bx Dly Term B 3	200 to 500	Amp/Multiplier Adjustments
186	YTM Bx Dly Term B 4	200 to 500	Amp/Multiplier Adjustments
187	YTM Bx Dly Term B 5	200 to 500	Amp/Multiplier Adjustments
188	YTM Bx Dly Term B 6	200 to 500	Amp/Multiplier Adjustments
189	YTM Bx Dly Term B 7	200 to 500	Amp/Multiplier Adjustments
190			
191			
192			
193			
194			
195	YTM Kick Threshold	110	Amp/Multiplier Adjustments
196	YTM CW Kick Max	9000	Amp/Multiplier Adjustments
197	YTM Mono Band Kick	2000	Amp/Multiplier Adjustments
198	YTM Stereo Band Kick	2000	Amp/Multiplier Adjustments
199	YTM Slew Rate	400	Amp/Multiplier Adjustments
200	YTM Slew Max	50	
201	YTM Slew Min	0	
202	YTM Neg Kick Wait	2	
203	YTM Fwd Kick Pct	50	
204	YTM Fwd Kick Wait	30	
205	YTM Rise; Band 1	1 to 20	Amplifier/Filter Adjustments
206	YTM Rise; Band 2 A1	20 to 25	Amplifier/Filter Adjustments
207	YTM Rise; Band 2 B1	1 to 4	Amplifier/Filter Adjustments
208	YTM Rise; Band 2 A2	10 to 20	Amplifier/Filter Adjustments
209	YTM Rise; Band 3 A1	5 to 255	Amplifier/Filter Adjustments
210	YTM Rise; Band 3 B1	0 to 50	Amplifier/Filter Adjustments
211	YTM Rise; Band 3 A2	5 to 255	Amplifier/Filter Adjustments
212	YTM Rise; Band 3 B2	0 to 50	Amplifier/Filter Adjustments
213	YTM Rise; Band 3 A3	1 to 20	Amplifier/Filter Adjustments

**Table 3-9. Calibration Constant Descriptions (continued)**

Number	Description	Range or Default	Related Adjustment
214	YTM Rise; Band 4	1 to 50	Amplifier/Filter Adjustments
215	YTM Rise; Band 5	1 to 50	Amplifier/Filter Adjustments
216	YTM Rise; Band 6	1 to 50	Amplifier/Filter Adjustments
217	YTM Rise; Band 7	0	Amplifier/Filter Adjustments
218			
219			
220			
221			
222			
223			
224			
225	*YTM Gain; Band 1	1500 to 2500	Amp/Multiplier Adjustments; Auto Track
226	*YTM Gain; Band 2	1000 to 2500	Amp/Multiplier Adjustments; Auto Track
227	*YTM Gain; Band 3	500 to 2500	Amp/Multiplier Adjustments; Auto Track
228	*YTM Gain; Band 4	1000 to 2500	Amp/Multiplier Adjustments; Auto Track
229	*YTM Gain; Band 5	500 to 2500	Amp/Multiplier Adjustments; Auto Track
230	*YTM Gain; Band 6	500 to 2500	Amp/Multiplier Adjustments; Auto Track
231	*YTM Gain; Band 7	500 to 2500	Amp/Multiplier Adjustments; Auto Track
232			
233			
234			
235			
236			
237			
238	*YTM Offset; Band 1	1500 to 2500	Amp/Multiplier Adjustments; Auto Track
239	*YTM Offset; Band 2	1500 to 3000	Amp/Multiplier Adjustments; Auto Track

**Table 3-9. Calibration Constant Descriptions (continued)**

Number	Description	Range or Default	Related Adjustment
240	*YTM Offset; Band 3	1500 to 3000	Amp/Multiplier Adjustments; Auto Track
241	*YTM Offset; Band 4	1500 to 3000	Amp/Multiplier Adjustments; Auto Track
242	*YTM Offset; Band 5	1500 to 3000	Amp/Multiplier Adjustments; Auto Track
243	*YTM Offset; Band 6	1500 to 3000	Amp/Multiplier Adjustments; Auto Track
244	*YTM Offset; Band 7	1500 to 3000	Amp/Multiplier Adjustments; Auto Track
245			
246			
247			
248	YTM B2 Offset Offset	-50 to +50	Amp/Multiplier Adjustments
249			
250			
251	*LVL DAC Gain Hi Bnd	-100 to +100	ALC Power Level Accuracy; <u>Detector Cal</u>
252	*LVL DAC Gain Lo Bnd	-100 to +100	ALC Power Level Accuracy; <u>Detector Cal</u>
253	*LVL DAC Gain Xtal	-100 to +100	<u>Detector Cal</u>
254	*LVL DAC Gain 2ndOut	0	
255	*LVL DAC Gain PwrMtr	-100 to +100	
256	*LVL DAC Gain Module	-100 to +100	
257	*LVL DAC Gain ALC Off	0	
258			
259			
260			
261			
262			
263			
264	*LVL DAC Ofs Hi Bnd	-50 to +300	ALC Power Level Accuracy; <u>Detector Cal</u>

**Table 3-9. Calibration Constant Descriptions (continued)**

Number	Description	Range or Default	Related Adjustment
265	*LVL DAC Ofs Lo Bnd	100 to 250	ALC Power Level Accuracy; <u>Detector Cal</u>
266	*LVL DAC Ofs Xtal	-1000 to +1000	<u>Detector Cal</u>
267	*LVL DAC Ofs 2ndOut	0	
268	*LVL DAC Ofs PwrMtr	-100 to +100	
269	*LVL DAC Ofs Module	-100 to +100	
270	*LVL DAC Ofs ALC Off	0	
271			
272			
273			
274	Internal FM Flat	-10,000 to +10,000	Modulation Generator Flatness
275	FM DAC Gain Trim	-1000 to +1000	
276	AM DAC Gain Trim	-1000 to +1000	
277	AM Offset	-20 to +20	
278			
279			
280			
281			
282			
283	*ALC Det Ofs; Hi	100 to 160	ALC Power Level Accuracy; <u>Detector Cal</u>
284	*ALC Det Ofs; Lo	100 to 160	ALC Power Level Accuracy; <u>Detector Cal</u>
285	*ALC Det Ofs; Xtal	100 to 160	
286	*ALC Det Ofs; 2nd Out	100 to 160	
287			
288			
289			
290			
291			
292	*ALC Log Brkpt; Hi	0 to 255	ALC Power Level Accuracy; <u>Detector Cal</u>

**Table 3-9. Calibration Constant Descriptions (continued)**

Number	Description	Range or Default	Related Adjustment
293	*ALC Log Brkpt; Lo	0 to 255	ALC Power Level Accuracy; <u>Detector Cal</u>
294	*ALC Log Brkpt; Xtal	0 to 255	
295	*ALC Log Brkpt; 2nd	0 to 255	
296			
297			
298			
299			
300			
301	*ALC Mod Gain; Band 0	100 to 200	Modulator Offset And Gain
302	*ALC Mod Gain; Band 1	100 to 200	Modulator Offset And Gain
303	*ALC Mod Gain; Band 2	40 to 100	Modulator Offset And Gain
304	*ALC Mod Gain; Band 3	40 to 100	Modulator Offset And Gain
305	*ALC Mod Gain; Band 4	40 to 100	Modulator Offset And Gain
306	*ALC Mod Gain; Band 5	40 to 100	
307	*ALC Mod Gain; Band 6	40 to 100	
308	*ALC Mod Gain; Band 7	40 to 100	
309			
310			
311			
312			
313			
314			
315	ALC Mod Ofs; Band 0	50 to 150	Modulator Offset And Gain
316	ALC Mod Ofs; Band 1	50 to 150	Modulator Offset And Gain
317	ALC Mod Ofs; Band 2	150 to 220	Modulator Offset And Gain
318	ALC Mod Ofs; Band 3	150 to 220	Modulator Offset And Gain
319	ALC Mod Ofs; Band 4	100 to 200	Modulator Offset And Gain
320	ALC Mod Ofs; Band 5	100 to 200	
321	ALC Mod Ofs; Band 6	100 to 200	
322	ALC Mod Ofs; Band 7	100 to 200	

**Table 3-9. Calibration Constant Descriptions (continued)**

Number	Description	Range or Default	Related Adjustment
323			
324			
325			
326			
327			
328			
329	Slow Sym Low Band	100 to 160	
330	Slow Sym High Band	100 to 160	
331	Attenuator Sw Point	-1000	
332			
333			
334			
335	Squegg Clamp 1B	40 to 200	
336	Squegg Clamp 2B	50 to 255	
337	Squegg Clamp 3B	50 to 255	
338	Squegg Clamp 4B	50 to 255	
339	Squegg Clamp 5B	50 to 255	
340	Squegg Clamp 6B	50 to 255	
341	Squegg Clamp 7B	50 to 255	
342			
343			
344			
345			
346			
347			
348			
349			
350			
351	ADC 5V Range +OFF	-5000 to +5000	ADC Adjustment
352	ADC 15V Range +OFF	-5000 to +5000	ADC Adjustment
353	ADC 5V Range +GAIN	-1950 to +1950	ADC Adjustment

**Table 3-9. Calibration Constant Descriptions (continued)**

Number	Description	Range or Default	Related Adjustment
354	ADC 15V Range +GAIN	-750 to +750	ADC Adjustment
355	ADC 5V Range -OFF	-5000 to +5000	ADC Adjustment
356	ADC 15V Range -OFF	-5000 to +5000	ADC Adjustment
357	ADC 5V Range -GAIN	-750 to +750	ADC Adjustment
358	ADC 15V Range -GAIN	-1750 to +1950	ADC Adjustment
359			
360			
361			
362			
363			
364			
365			
366			
367	PwrMtr Gain; Lo Band	0	
368	PwrMtr Gain; Hi Band	0	
369	Pwr Mtr Offset	0	
370			
371			
372			
373	YTM Dly Term C Hrm 1	50	
374	YTM Dly Term C Hrm 2	30	
375	YTM Dly Term C Hrm 3	30	
376	YTM Dly Term C Hrm 4	0	
377	YTM Dly Term C Hrm 5	0	
378	YTM Dly Term C Hrm 6	0	
379	YTM Dly Term C Hrm 7	0	
380			
381			
382	YTM Bx Dly Term C 1	0	
383	YTM Bx Dly Term C 2	0	
384	YTM Bx Dly Term C 3	40	
385	YTM Bx Dly Term C 4	0	



**Table 3-9. Calibration Constant Descriptions (continued)**

Number	Description	Range or Default	Related Adjustment
386	YTM Bx Dly Term C 5	0	
387	YTM Bx Dly Term C 6	0	
388	YTM Bx Dly Term C 7	0	
389			
390			
391			
392			
393	*Loop Gain: 200.0 MHz	10 to 20	Sampler Assembly
394	*Loop Gain: 200.5 MHz	10 to 20	Sampler Assembly
395	*Loop Gain: 201.0 MHz	10 to 20	Sampler Assembly
396	*Loop Gain: 201.5 MHz	10 to 20	Sampler Assembly
397	*Loop Gain: 202.0 MHz	10 to 20	Sampler Assembly
398	*Loop Gain: 202.5 MHz	10 to 20	Sampler Assembly
399	*Loop Gain: 203.0 MHz	10 to 20	Sampler Assembly
400	*Loop Gain: 203.5 MHz	10 to 20	Sampler Assembly
401	*Loop Gain: 204.0 MHz	10 to 20	Sampler Assembly
402	*Loop Gain: 204.5 MHz	10 to 20	Sampler Assembly
403	*Loop Gain: 205.0 MHz	10 to 20	Sampler Assembly
404	*Loop Gain: 205.5 MHz	10 to 20	Sampler Assembly
405	*Loop Gain: 206.0 MHz	10 to 20	Sampler Assembly
406	*Loop Gain: 206.5 MHz	10 to 20	Sampler Assembly
407	*Loop Gain: 207.0 MHz	10 to 20	Sampler Assembly
408	*Loop Gain: 207.5 MHz	10 to 20	Sampler Assembly
409	*Loop Gain: 208.0 MHz	10 to 20	Sampler Assembly
410	*Loop Gain: 208.5 MHz	10 to 20	Sampler Assembly
411	*Loop Gain: 209.0 MHz	10 to 20	Sampler Assembly
412	*Loop Gain: 209.5 MHz	10 to 20	Sampler Assembly
413	*Loop Gain: 210.0 MHz	10 to 20	Sampler Assembly
414	*Loop Gain: 210.5 MHz	10 to 20	Sampler Assembly
415	*Loop Gain: 211.0 MHz	10 to 20	Sampler Assembly
416	*Loop Gain: 211.5 MHz	12 to 24	Sampler Assembly
417	*Loop Gain: 212.0 MHz	13 to 26	Sampler Assembly
418	*Loop Gain: 212.5 MHz	14 to 28	Sampler Assembly

**Table 3-9. Calibration Constant Descriptions (continued)**

Number	Description	Range or Default	Related Adjustment
419	*Loop Gain: 213.0 MHz	14 to 28	Sampler Assembly
420	*Loop Gain: 213.5 MHz	15 to 30	Sampler Assembly
421	*Loop Gain: 214.0 MHz	16 to 32	Sampler Assembly
422	*Loop Gain: 214.5 MHz	17 to 34	Sampler Assembly
423	*Loop Gain: 215.0 MHz	18 to 36	Sampler Assembly
424	*Loop Gain: 215.5 MHz	18 to 36	Sampler Assembly
425	*Loop Gain: 216.0 MHz	19 to 38	Sampler Assembly
426	*Loop Gain: 216.5 MHz	20 to 40	Sampler Assembly
427	*Loop Gain: 217.0 MHz	22 to 44	Sampler Assembly
428	*Loop Gain: 217.5 MHz	23 to 46	Sampler Assembly
429	*Loop Gain: 218.0 MHz	24 to 48	Sampler Assembly
430	*Loop Gain: 218.5 MHz	28 to 56	Sampler Assembly
431	*Loop Gain: 219.0 MHz	30 to 60	Sampler Assembly
432	*Loop Gain: 219.5 MHz	32 to 64	Sampler Assembly
433	*Loop Gain: 220.0 Mhz	32 to 64	Sampler Assembly
434			
435			
436			
437			
438			
439			
440	Doubler Amp Mode	0	
441	Phuoc Magic Enable	0	
442	*Sweeptime Range 0	3750 to 6250	Sweep Ramp
443	*Sweeptime Range 1	19655 to 32755	Sweep Ramp
444	*Sweeptime Range 2	9360 to 15600	Sweep Ramp
445			
446			
447			
448			
449			
450			

**Table 3-9. Calibration Constant Descriptions (continued)**

Number	Description	Range or Default	Related Adjustment
451			
452			
453			
454			
455			
456			
457			
458			
459			
460	Debugs	0	
461	Serial Numb Prefix	See footnote 1	
462			
463	Hardware Config 1	See footnote 1	
464	Hardware Config 2	See footnote 1	
465			
466			
467			
468			
469			
470			
471			
472			
473	Power Spec Band 0	See footnote 2	
474	Power Spec Band 1	See footnote 2	
475	Power Spec Band 2	See footnote 2	
476	Power Spec Band 3	See footnote 2	
477	Power Spec Band 4	See footnote 2	
478	Power Spec Band 5	See footnote 2	
479	Power Spec Band 6	See footnote 2	
480	Power Spec Band 7	See footnote 2	
481			
482			
483			

**Table 3-9. Calibration Constant Descriptions (continued)**

Number	Description	Range or Default	Related Adjustment
484			
485			
486			
487	Max Sweep Rate	300	
488	Max Sweep Rate 8516	100	
489			
490			
491			
492			
493	A1 Revision	See footnote 3	
494	A2 Revision	See footnote 3	
495	A3 Revision	See footnote 3	
496	A4 Revision	See footnote 3	
497	A5 Revision	See footnote 3	
498	A6 Revision	See footnote 3	
499	A7 Revision	See footnote 3	
500	A8 Revision	See footnote 3	
501	A9 Revision	See footnote 3	
502	A10 Revision	See footnote 3	
503	A11 Revision	See footnote 3	
504	A12 Revision	See footnote 3	
505	A13 Revision	See footnote 3	
506	A14 Revision	See footnote 3	
507	A15 Revision	See footnote 3	
508	A16 Revision	See footnote 3	
509	A17 Revision	See footnote 3	
510	A18 Revision	See footnote 3	
511	A19 Revision	See footnote 3	
512	A20 Revision	See footnote 3	
513	A21 Revision	See footnote 3	
514	A22 Revision	See footnote 3	
515	A23 Revision	See footnote 3	
516			

**Table 3-9. Calibration Constant Descriptions (continued)**

Number	Description	Range or Default	Related Adjustment
517			
518			
519			
520			
521			
522			
523			
524			
525	Hibernation Time	90	
526	Bandcross Time 1	42	
527	Bandcross Time 2	32	
528	Bandcross Time 3	28	
529	Bandcross Time 4	50	
530	Bandcross Time 5	28	
531	Bandcross Time 6	20	
532	Bandcross Time 7	20	
533			
534			
535			
536	Special Option 1	0	
537	Special Option 2	0	
538	Special Option 3	0	
539	Special Option 4	0	
540	Special Option 5	0	
541	Special Option 6	0	
542	Special Option 7	0	
543	Special Option 8	0	
544	Special Option 9	0	
545	Special Option 10	0	

**Table 3-9. Calibration Constant Descriptions (continued)**

Number	Description	Range or Default	Related Adjustment
546			
547			
548			
549			
550			
551			
552			
553			
554	Display FIFO Time	245	
555	Display FSCC Time	1	
556			
557			
558			
559			
560			
561	YTF Dly Term A Hrm 1	1000	
562	YTF Dly Term A Hrm 2	1000	
563	YTF Dly Term A Hrm 3	1000	
564	YTF Dly Term A Hrm 4	1000	
565	YTF Dly Term A Hrm 5	1000	
566	YTF Dly Term A Hrm 6	1000	
567	YTF Dly Term A Hrm 7	1000	
568			
569			
570			
571	YTF Dly Term B Hrm 1	300	
572	YTF Dly Term B Hrm 2	300	
573	YTF Dly Term B Hrm 3	300	
574	YTF Dly Term B Hrm 4	300	
575	YTF Dly Term B Hrm 5	300	
576	YTF Dly Term B Hrm 6	300	
577	YTF Dly Term B Hrm 7	300	

**Table 3-9. Calibration Constant Descriptions (continued)**

<b>Number</b>	<b>Description</b>	<b>Range or Default</b>	<b>Related Adjustment</b>
578			
579			
580			
581	YTF Dly Term C Hrm 1	0	
582	YTF Dly Term C Hrm 2	0	
583	YTF Dly Term C Hrm 3	0	
584	YTF Dly Term C Hrm 4	0	
585	YTF Dly Term C Hrm 5	0	
586	YTF Dly Term C Hrm 6	0	
587	YTF Dly Term C Hrm 7	0	
588			
589			
590			
591	YTF Bx Dly Term A 1	1000	
592	YTF Bx Dly Term A 2	1000	
593	YTF Bx Dly Term A 3	1000	
594	YTF Bx Dly Term A 4	1000	
595	YTF Bx Dly Term A 5	1000	
596	YTF Bx Dly Term A 6	1000	
597	YTF Bx Dly Term A 7	1000	
598			
599			
600			
601	YTF Bx Dly Term B 1	30	Amplifier/Filter Adjustments
602	YTF Bx Dly Term B 2	30	Amplifier/Filter Adjustments
603	YTF Bx Dly Term B 3	30	Amplifier/Filter Adjustments
604	YTF Bx Dly Term B 4	30	Amplifier/Filter Adjustments
605	YTF Bx Dly Term B 5	30	Amplifier/Filter Adjustments
606	YTF Bx Dly Term B 6	30	Amplifier/Filter Adjustments
607	YTF Bx Dly Term B 7	30	Amplifier/Filter Adjustments

**Table 3-9. Calibration Constant Descriptions (continued)**

Number	Description	Range or Default	Related Adjustment
608			
609			
610			
611	YTF Bx Dly Term C 1	0	
612	YTF Bx Dly Term C 2	0	
613	YTF Bx Dly Term C 3	0	
614	YTF Bx Dly Term C 4	0	
615	YTF Bx Dly Term C 5	0	
616	YTF Bx Dly Term C 6	0	
617	YTF Bx Dly Term C 7	0	
618			
619			
620			
621	*YTF Gain; Band 1	2048	Amplifier/Filter Adjustments
622	*YTF Gain; Band 2	2048	Amplifier/Filter Adjustments
623	*YTF Gain; Band 3	2048	Amplifier/Filter Adjustments
624	*YTF Gain; Band 4	2048	Amplifier/Filter Adjustments
625	*YTF Gain; Band 5	2048	Amplifier/Filter Adjustments
626	*YTF Gain; Band 6	2048	Amplifier/Filter Adjustments
627	*YTF Gain; Band 7	2048	Amplifier/Filter Adjustments
628			
629			
630			
631	*YTF Offset; Band 1	2048	Amplifier/Filter Adjustments
632	*YTF Offset; Band 2	2048	Amplifier/Filter Adjustments
633	*YTF Offset; Band 3	2048	Amplifier/Filter Adjustments
634	*YTF Offset; Band 4	2048	Amplifier/Filter Adjustments
635	*YTF Offset; Band 5	2048	Amplifier/Filter Adjustments
636	*YTF Offset; Band 6	2048	Amplifier/Filter Adjustments
637	*YTF Offset; Band 7	2048	Amplifier/Filter Adjustments
638			
639			
640			



**Table 3-9. Calibration Constant Descriptions (continued)**

Number	Description	Range or Default	Related Adjustment
641	A24 Rev;Low Band	See footnote 3	
642	A25 Rev;Mod Splitter	See footnote 3	
643	A26 Rev;YIG Osc	See footnote 3	
644	A27 Rev;Isolator	See footnote 3	
645	A28 Rev;SYTM	See footnote 3	
646	A29 Rev;Amp/Detector	See footnote 3	
647	A30 Rev;Coupler	See footnote 3	
648	A31 Rev;Attenuator	See footnote 3	
649	A32 Rev;Doubler	See footnote 3	
650	A33 Rev;Amplifier	See footnote 3	
651	A34 Rev;RP Assembly	See footnote 3	
652	A35 Rev;Isolator	See footnote 3	
653	A36 Rev;Pulse Mod	See footnote 3	
654			
655	A38 Rev;Dual Mod	See footnote 3	
656			
657			
658			
659			
660	Quick Step Slew 0	120 — A13 Revision=4 5 — All others	
661	Quick Step Slew 1	120 — A13 Revision=4 5 — All others	
662	Quick Step Slew 2	60 — A13 Revision=4 10 — All others	
663	Quick Step Slew 3	40 — A13 Revision=4 15 — All others	
664	Quick Step Slew 4	30 — A13 Revision=4 17 — All others	
665	Quick Step Slew 5	20 — A13 Revision=4 26 — All others	
666	Quick Step Slew 6	20 — A13 Revision=4 26 — All others	
667	Quick Step Slew 7	15 — A13 Revision=4 35 — All others	

**Table 3-9. Calibration Constant Descriptions (continued)**

Number	Description	Range or Default	Related Adjustment
668			
669			
670	Rf Interface ID	See footnote 3	
671	A9 Pulse Board ID	See footnote 3	
672	A12 YTM Driver ID	See footnote 3	
673	A28 Amp/Mult ID	See footnote 3	
674	A29 Amp/Filt ID	See footnote 3	
675	A38 Dual Mod ID	See footnote 3	
676			
677			
678			
679			
680			
681			
682			
683			
684			
685			
686			
687			
688			
689			
690			

<sup>1</sup> Specific to the synthesizer's hardware configuration. The calibration constant value is set at the factory. X20See Table 3-10.

<sup>2</sup> Specified maximum leveled power for the band (for example, 7 dBm equals 700, 10 dBm equals 1000).

<sup>3</sup> Specific to the synthesizer's hardware configuration. The calibration constant ID number and revision vary depending on the assembly version. See Table 3-11.

**Table 3-10.**  
**Hardware Configuration Cal Constants #463 and #464**

Synthesizer Model Number	Cal Constant #463 Hardware Config 1						#464 Hardware Config 2
	Starting Cal Constant	Option 001	Option 002	Option 004	Option 006	Option H10	
HP83620A	+144	-128	+4	+4096	-	-127	1
HP83622A	+128	-128	+4	+4096	-	-127	1
HP83623A	+152	-128	+4	+4096	-	-127	1
HP83624A	+136	-128	+4	+4096	-	-127	1
HP83630A	+19,600	-128	+4	+4096	-	-127	1
HP83640A	+176	-128	+4	+4096	-	-127	1
HP83642A	+160	-128	+4	+4096	-	-127	-
HP83650A	+19,888	-128	+4	+4096	-	-127	1
HP83621A	+30,864	-	-	-	-	-	-
HP83631A	+30,864	-	-	-	-	-	-
HP83651A	+32,176	-	-	-	-	-	-

Option H10 and all other options are *mutually exclusive*.

**Example:**

$$\begin{aligned} \text{HP 83620A} + 001 + 006 &= ? \\ 19,600 - 128 + 2 &= 19,474 \end{aligned}$$

.... or

$$\begin{aligned} \text{HP 83642} + 003 + 004 &= ? \\ 160 + 4 + 4096 &= 4260 \end{aligned}$$

**Table 3-11.  
Assemblies and Corresponding Cal Constant ID Numbers and  
Revisions**

Assembly	ID Number	Revision	Part Number	Description
A1	None	#493 0	08360-60001	Keyboard
A2	None	#493 0	08360-60002	Source Module Interface
A3	None	#495 0	08360-60003	Front Panel Processor
A4	None	#496 0	08360-60010	Fractional-N
A5	None	#497 0 1	08360-60009 08360-60209	YO Phase Detector YO Phase Detector
A6	None	#498 0 1 1	08360-60007 08360-60007 08360-60214	Sampler (With VCO Adj.) Sampler (No VCO Adj.) Sampler (No VCO Adj.)
A7	None	#499 0 1	08360-60008	Reference Future Use
A8	None	#500 0	08360-60166	Modulation Generator
A9	#671 0 0 0 1 2	#501 0 1 2 0 0	08360-60005 08360-60152 08360-60205 08360-60188	Pulse Pulse (Opt. 006 Compatible) Pulse (Dual Slope Squegg Clamp) Pulse (Self Bias SRD) Pulse (HP 83630A H35)
A10	None	#502 0 0 0	08360-60006 08360-60206 08360-60222	ALC

**Table 3-11.  
Assemblies and Corresponding Cal Constant ID Numbers and  
Revisions (continued)**

Assembly	ID Number	Revision	Part Number	Description
A11	None	#503 0	08360-60011	FM Driver
A12	#672 0 1	#504 0 0	08360-60012 08360-60212	SYTM Driver Multiplier/Filter Driver
A13	None	#505 0 1 2 3 4	08360-60013 08360-60013 08360-60213 08360-60207	Never Used YO Driver Never Used YO Driver (HP 83621A/31A/51A) YO Driver (Quick Step)
A14	None	#506 0	08360-60014	Sweep Generator
A15	None	#507 0 1	08360-60015 08360-60215	CPU (Battery) CPU (Supercap)
A16	None	#508 0	08360-60016	Post Regulator
A17	None	#509 0	08360-60017	Rectifier/Filter
A18	None	#510 0 0	08360-60018 08360-60198	Switching Regulator Switching Regulator
A19	None	#511 0	08360-60019	Rear Panel Interface
A20	#670 0	#512 0 1 1	08360-60004 08360-60187 08360-60223	RF Interface RF Interface RF Interface
A21	None	#513 0	1990-1295	Alphanumeric Display

**Table 3-11.  
Assemblies and Corresponding Cal Constant ID Numbers and  
Revisions (continued)**

Assembly	ID Number	Revision	Part Number	Description
A22	None	#514		
		0	08360-60196	Motherboard
		0	08360-60022	Motherboard
A23	None	#515		
		0	HP 10811E	10 MHz Reference Standard
A24	None	#641		
		0	5086-7463	Low Band
A25	None	#642		
		0	5086-7464	Mod Splitter
		1		Directional Coupler
A26	None	#643		
		0	5086-7505	YO
			5086-7515	YO
A27	None	#644		
		0	0955-0475	Isolator
A28	#673	#645		
	0	0	5086-7503	SYTM
		0	5086-7545	SYTM
	1	0	5086-7596	Switched Amp/Mult (HP 83621A/31A)
		1	5086-7596	Switched Amp/Mult (HP 83630A H35)
	2	0	5086-7585	Amplifier/Multiplier (HP 83651A)
	2	1	5086-7622	Amplifier/Multiplier (HP 83630A/50A)
A29	#674	#646		
	0	0	5086-7562	Amp/Detector (HP 83620A/22A, HP 83623A/24A, HP 83640A/42A)
	1	0	5086-7586	Amp/Filter (HP 83651A)
		1	5086-7623	Amp/Filter (HP 83630A/50A)
	2	0		Dassault Amp/Filter #73
	3	0		Future Use
4	0		Future Use	

**Table 3-11.  
Assemblies and Corresponding Cal Constant ID Numbers and  
Revisions (continued)**

Assembly	ID Number	Revision	Part Number	Description
A30	None	#647		
		0	0955-0148	Directional Coupler (HP 83620A/22A, HP 83623A/24A)
		0	0955-0125	Directional Coupler (HP 83630A/31A)
		0	0955-0472	Directional Coupler (HP 83640A/42A)
A31	None	0	0955-0523	Directional Coupler (HP 83650A/51A)
		#648		
		0	33326-60003	Step Attenuator
		0	33326-60002	Step Attenuator
A32	None	#649		
		0	5086-7507	Frequency Doubler (40 GHz)
A33	None	0	5086-7513	Frequency Doubler (50 GHz)
		#650		
A34	None	0	5086-7465	Amplifier (High Power)
		#651		
A35	None	0	08360-60061	RP Floating BNC
		#652		
A36	None	0	0955-0475	Isolator
		#653		
		0	5086-7565	Pulse Modulator (Option 006)
		1	5086-7582	Pulse Modulator (Option H06)
A37		1	5086-7588	Pulse Modulator (Option H07)
A38	#675	#655		
	0	0		Dual Modulator (HP 83630A H35)
	1	0	5086-7602	Dual Modulator (HP 83630A/50A)

## **4** AUTOMATED TESTS



## Automated Tests

---

### Introduction

This chapter contains information on how to load and run the “HP 8360 Service Support Software” revision A.01.20. Included are automated performance tests, automated adjustments, front panel emulation program, and calibration utility. These tests require operator interaction.

This software requires that the synthesizer is set to the SCPI programming language. This is set by the rear panel switch or by the front panel. Refer to the “Installation” chapter of the *User’s Handbook* for further information. After using the software, return the synthesizer to its original setting.

This chapter contains the following information on using the software:

- Setting Up the System.
- Installing the Software.
- Running the Software.
- Reporting Software Bugs.
- Automated Performance Tests.
  - Step Attenuator Flatness Test.
  - Power Flatness and Accuracy Test.
- Automated Adjustments.
  - Step Attenuator Flatness Adjustment.
  - YO Delay Adjustment.
  - ADC Adjustment.
  - Power Flatness Adjustment.
- Utilities.
  - Front Panel Emulation.
  - Calibration Constants.
  - Self-Test.
  - Power Sensor Configuration and Calibration Factor File
- Software Support Request.

---

## Setting Up the System

### Hardware Requirements

The automated tests require an HP 9000 series 200/300 desktop computer with at least 2.25 megabytes of RAM, a disk drive, and an HP-IB interface. This program will not run with high resolution color monitors (> 512 x 390 pixels). Software is provided on 3.5 inch disks, formatted double-sided, and are usable in double-sided disk drives only. If you require single-sided disks, see "Double- to Single-Sided Disk Conversion" under "Installing the Software" in this chapter. Any required measurement instruments are listed in each test procedure.

### Operating System Requirements

The test software requires BASIC version 5.1 and the following binaries.

Table 4-1. Required Binaries

Language Extensions	Drivers
CLOCK	CRTA or CRTB (depends on CRT)
COMPLEX	CS80 or DISC (depends on disk)
CRTX	HFS
EDIT	HPIB
ERR	SRM
GRAPH	
GRAPHX	
IO	
KBD	
MAT	
MS	
PDEV	
TRANS	
XREF	

Refer to the BASIC user's documentation for instructions on loading the operating system and binaries.

---

## Installing the Software

### Disk Files

The automated tests are provided on one double-sided disk. Previous revisions were provided on two double-sided disks.

### Make Working Copies

Before doing anything else, make a working copy of the master disk!

**Note:** When copying onto another 3.5 inch, double-sided disk, you must specify the interleave factor to be used during initialization of your blank disk. The required interleave factor is 2 and sector size must be 1 kbyte.

Type: INITIALIZE "Address of drive containing blank floppy",2,3

The master disk is shipped from the factory write-protected and cannot be written to or initialized in this mode. We recommend you maintain this master disk in write-protect mode. During execution of some tests, the program reads from and writes to the disk, use a working copy that is not write-protected when you run the software.

### Installing the Program Onto a Hard Disk

We recommend that you run the software from a hard disk. It is possible to operate it from a single or dual floppy disk drive, however speed will be sacrificed.

To install the program onto your hard disk, create a directory that will contain the program and its associated files. (Refer to the BASIC user's documentation for instructions on creating directories.) After you create the directory, run the install program below to load all of the files onto your hard disk.

1. Insert the master disk.
2. In the directory created, type: LOAD "COPY\_DISK" and press **RETURN**.
3. Press **RUN** and follow the prompts.

Your hard disk is now set up to run the automated tests.

## Operating From a Floppy Disk

When you run the software from a floppy disk drive, be sure to leave the disk in the disk drive while the program runs. If this is not done, the program will not run.

## Double-to Single-Sided Disk Conversion

If you require a single-sided disk, the master disks can be converted to single-sided format using a double-sided disk drive. Use the following procedure to make the conversion. Press **RETURN** after each command. For information on formatting a single-sided disk on a double-sided drive, refer to the BASIC user's documentation.

1. Insert the double-sided disk into the disk drive.
2. Set the default mass storage to the drive containing the disk. Type:  
LOAD "OPV\_8360"  
DEL label\_1, 32000
3. Remove the disk and insert a single-sided, formatted disk into the same drive (Disk 1A). Type:  
STORE "8360\_1A"
4. Remove the disk and insert the original disk. Type:  
LOAD "OPV\_8360"  
DEL label\_2, 32000  
DEL 1, label\_1
5. Remove the disk and insert another single-sided, formatted disk into the same drive (Disk 1B). Type:  
STORE "8360\_1B"
6. Remove the disk and insert the original disk. Type:  
LOAD "OPV\_8360"  
DEL 1,label\_2

7. Remove the disk and insert another single-sided, formatted disk into the same drive (Disk 1C). Type:

STORE "8360\_1C"

8. Remove the disk and insert the original disk. Insert another single-sided, formatted disk (Disk 1D) into another disk drive. Type:

LOAD "COPY\_DISK"

Press **RUN**.

9. Follow the instructions to copy files from the original disk to another single-sided, formatted disk. The source and destination drives cannot be the same. Also, an error will be indicated when the software attempts to copy OPV\_8360. This is normal.

---

## Running the Software

---

### Caution



This software uses RAM memory volumes for fast access of data files. These volumes may also be used by other programs and could contain data that will be erased by this program. Make sure that the computer you are using does not have important data in any memory volumes before running this software.

---

## Configuration Limitations

The computer containing the software must be the *only* controller on the bus. If more than one controller is present, the software will not run properly.

## Loading the Software

1. Make sure the software has been copied into a directory (if running from a hard disk) or copied to a work disk (if running from a floppy disk).
2. Set the default mass storage to the directory or floppy disk that contains the test software. Use the BASIC MSI command. See the *BASIC Language Reference* for more information on setting the default mass storage.

**NOTE:** CAPS LOCK ON or OFF cannot be changed while the program is running. Set the keyboard before you load the software.

3. Load the test software.

Insert the disk in your default drive, or from your hard-drive directory, perform the following: (for single-sided formatted disks, see "Loading Single-Sided-Disks"). Type:

LOAD "OPV\_8360"

Press **RETURN**.

4. Press **RUN** to start the test program.

5. Some important messages are displayed, then the program displays a menu with the available model numbers. Using the arrow keys, select the correct model to be tested. Press **SELECT**.

6. The program asks for the installed options and the serial number of the unit under test. Enter the appropriate information.

7. A menu of the available tests is displayed. Using the arrow keys, select the appropriate test. Press **SELECT**.

**Note** Refer to the following pages for a detailed description and specific operating information (if any) for a specific test.

8. Follow the prompts in the individual tests for connection instructions and other relevant test information. When the test finishes, you are returned to the test menu.

9. Either select another test to run or select the **DONE** softkey to exit the program.

### Loading Single-Sided Formatted Disks

Use the following steps to load single-sided disks. Press **RETURN** after each command.

1. Insert Disk 1A into your default drive. Type:

LOAD "8360\_1A"

2. Remove Disk 1A and insert Disk 1B. Type:

LOADSUB ALL FROM "8360\_1B"

3. Remove Disk 1B and insert Disk 1C. Type:

LOADSUB ALL FROM "8360\_1C"

4. Remove Disk 1C and insert Disk 1D. Press **RUN**.

---

## Reporting Software Bugs

If a test does not run correctly, re-run the test. If the test fails to run properly again, fill out the "Software Support Request" at the end of this chapter and return it to your local HP sales office.

---

## AUTOMATED PERFORMANCE TESTS

---

### 1. Step Attenuator Flatness Test

#### Description

A power meter is used to make relative power measurements to determine the actual attenuation of each attenuator card. Mismatch error is minimized by including a fixed attenuation in front of the card being measured for both parts of the relative measurement (with/without the card). The software uses the value of each attenuator card to calculate what the actual attenuation is when set to a specific value. For example, the attenuator value for the 30 dB setting is the sum of the 10 dB and the 20 dB cards. The effect of digital ALC correction is accounted for by the software.

The following test equipment is required for this performance test. No substitutions are allowed.

**Table 4-2. Test Equipment Required**

Instrument	HP Model Number
10 dB Attenuator	8493C
30 dB Attenuator	11708A
Power Meter	438A
Power Sensor (50 MHz to 26.5 GHz)	8485A <sup>1</sup>
Power Sensor (50 MHz to 26.5 GHz)	8485D <sup>1</sup>
Power Sensor (100 kHz to 4.2 GHz)	8482A

<sup>1</sup> Substitute HP 8487A/D for 40 GHz synthesizers.



## Procedure

Connect the equipment as shown in Figure 4-1. Preset all instruments and let them warm up for at least one hour.

**Note:** This program requires that power sensor calibration factors be stored in a file. If the calibration factors have not been entered previously, refer to the "Power Sensor Configuration and Calibration Factor File" utility.

Select the step attenuator flatness test and follow the prompts on the display.

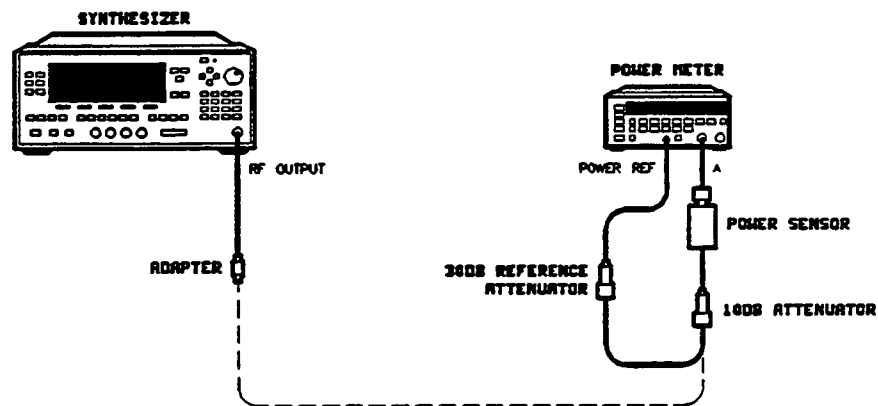

Figure 4-1. Step Attenuator Flatness Test Setup

---

## 2. Power Flatness and Accuracy Test

### Description

**Note:** If Option 001 is installed in your instrument, this test is not necessary as long as the "Step Attenuator Flatness" test is performed.

This test is provided as a softkey on the front panel, but cannot be run by the front panel emulation program because of its interaction with the power meter.

This test uses the user flatness correction array to measure power flatness at the RF output. The power is measured every 10 MHz in low band and every 100 MHz in high and millimeter bands. The calibration constants are adjusted to achieve a flat output.

The calibration factors for the power sensor must be added to the program before the test is run. Refer to the "Power Sensor Configuration and Calibration Factor File" if necessary.

The following test equipment is required for this test. No substitutions are allowed. (The test setup is given in the software.)

#### Test Equipment Required

Instrument	HP Model Number
Power Meter	438A
Power Sensor (100 kHz to 4.2 GHz)	8482A
Power Sensor (50 MHz to 26.5 GHz)	8485A
Power Sensor (50 MHz to 50 GHz) <sup>1</sup>	8487A
10 dB Attenuator (DC to 26.5 GHz) <sup>2</sup>	8493C

<sup>1</sup> For 40 GHz synthesizers only.

<sup>2</sup> For high power synthesizers only.

## Procedure

Select the power flatness and accuracy test and enter your power sensor data by performing the following steps.

**Note:** If the power sensor data was added previously, and is still current, skip the following steps and run the test.

1. Select the HELP softkey to access the power sensor configuration and calibration menus.
2. Select power meter configuration.
3. Select the sensor to edit.
4. Enter the power sensor configuration data (follow the prompts on the display).

**Note:** Do *not* edit the "Sensor ID". The names set at the factory must remain unchanged for the program to run properly. The factory recommended "Zero Hr" is 1.00 and the "Cal Hr" is 24.00. Use the left and right arrows to move the cursor within a field. Use the up and down arrows to increment or decrement the value. RETURN selects the field.

5. When all changes have been made, select save power meter configuration.
6. Next select power meter calibration factors to add the power sensor calibration factors to the program.
7. Select current to change the active power sensor to the one for which you would like to enter the data.
8. Select edit header, and enter the serial number of the power sensor.
9. Select edit calibration factors.
10. Enter the calibration factors from your power sensor (follow the prompts on the display).
11. When all of the calibration factors have been added, select store calibration factors to store the calibration factors for future use.
12. Exit the power meter calibration.
13. Run the power flatness and accuracy test.

---

## AUTOMATED ADJUSTMENTS

---

### 1. Step Attenuator Flatness Adjustment

Before doing any adjustment, enter the password for access to the adjustment calibration constants. Use the front panel or the front panel emulation program provided with this software.

See the “Calibration Constants” chapter for information on enabling the calibration constants with the password.

#### Description

A power meter is used to make relative power measurements to determine the actual attenuation of each attenuator card. Mismatch error is minimized by including a fixed attenuation in front of the card being measured for both parts of the relative measurement (with/without the card). The software uses the value of each attenuator card to calculate what the actual attenuation is when set to a specific value. For example, the attenuator value for the 30 dB setting is the sum of the 10 dB and the 20 dB cards. The effect of digital ALC correction is accounted for by the software.

The following test equipment is required for this adjustment. No substitutions are allowed.

**Table 4-3. Test Equipment Required**

Instrument	HP Model Number
10 dB Attenuator	8493C
30 dB Attenuator	11708A
Power Meter	438A
Power Sensor (50 MHz to 26.5 GHz)	8485A <sup>1</sup>
Power Sensor (50 MHz to 26.5 GHz)	8485D <sup>1</sup>
Power Sensor (100 kHz to 4.2 GHz)	8482A

<sup>1</sup> Substitute HP 8487A/D for 40 GHz synthesizers.

## Procedure

Connect the equipment as shown in Figure 4-2. Preset all instruments and let them warm up for at least one hour.

Select the step attenuator flatness adjustment and follow the prompts on the display.

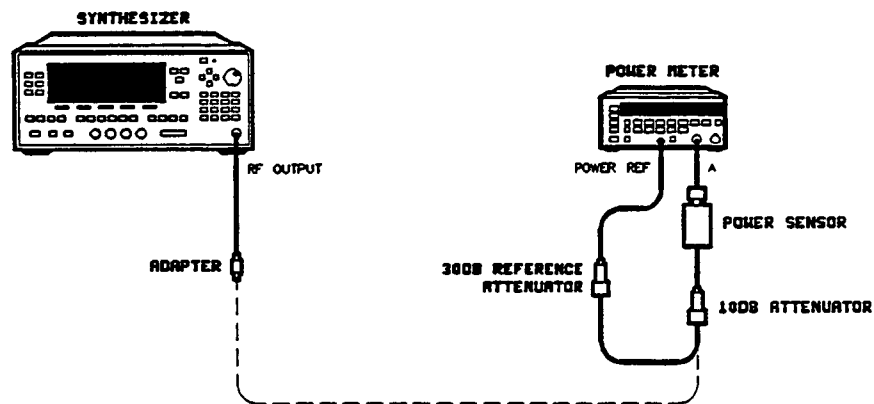

Figure 4-2. Step Attenuator Flatness Adjustment Setup

---

## 1. YO Delay Adjustment

### Description

This adjustment uses the internal counter to measure swept frequency accuracy. YO Delay affects the swept frequency accuracy at fast sweep times (less than 100 ms). This procedure adjusts the calibration constants for the YIG oscillator to achieve consistent swept frequency accuracy over the entire operating range of the instrument.

Select the YO delay adjustment and follow the prompts on the display.

No test equipment is required.

---

## 2. ADC Adjustment

### Description

This adjustment uses an external digital voltmeter (DVM) to measure VCOMP on the YO driver assembly and compares the reading to the ADC measurement. The ADC calibration constants are adjusted so that the DVM and ADC measurements are the same. The procedure is repeated for each voltage range (both plus and minus supplies).

Select the ADC adjustment and follow the prompts on the display.

The following test equipment is required for this adjustment. (The test setup is given in the software.)

#### Test Equipment Required

Instrument	HP Model Number
Digital Voltmeter	3456A, 3457A, or 3458A

---

### 3. Power Flatness Adjustment

#### Description

**Note:** If Option 001 is installed in your instrument, this adjustment is not necessary as long as the “Step Attenuator Flatness” adjustment is performed.

The test is provided as a softkey on the front panel, but cannot be run by the front panel emulation program because of its interaction with the power meter.

This adjustment zeros the digital ALC array and measures the power from the RF output. The power is measured every 10 MHz in low band and every 100 MHz in high and millimeter bands. The calibration constants are adjusted to achieve a flat output.

The calibration factors for the power sensor must be added to the program. Refer to the “Power Sensor Configuration and Calibration Factor File” as necessary.

The following test equipment is required for this adjustment. No substitutions are allowed. (The test setup is given in the software.)

#### Test Equipment Required

Instrument	HP Model Number
Power Meter	438A
Power Sensor (100 kHz to 4.2 GHz)	8482A
Power Sensor (50 MHz to 26.5 GHz)	8485A
Power Sensor (50 MHz to 50 GHz) <sup>1</sup>	8487A
10 dB Attenuator (DC to 26.5 GHz) <sup>2</sup>	8493C

1 For 40 GHz synthesizers only.

2 For high power synthesizers only.

## Procedure

Select the power flatness adjustment and enter your power sensor data by performing the following steps.

**Note:** If the power sensor data was added previously, and is still current, skip the following steps and run the test.

1. Select the **HELP** softkey to access the power sensor configuration and calibration menus.
2. Select power meter configuration.
3. Select the sensor to edit.
4. Enter the power sensor configuration data (follow the prompts on the display).

**Note:** Do *not* edit the "Sensor ID". The names set at the factory must remain unchanged for the program to run properly. The factory recommended "Zero Hr" is 1.00 and the "Cal Hr" is 24.00. Use the left and right arrows to move the cursor within a field and the up and down arrows to increment or decrement the value. **RETURN** selects the field.

5. When all changes have been made, select save power meter configuration.
6. Next select power meter calibration factors to add the power sensor calibration factors to the program.
7. Select current to change the active power sensor to the one for which you would like to enter the data.
8. Select edit header and enter the serial numbers of the power sensor.
9. Select edit calibration factors.
10. Enter the calibration factors from your power sensor (follow the prompts on the display).
11. When all of the calibration factors have been added, select store calibration factors to store the calibration factors for future use.
12. Exit the power meter calibration.
13. Run the power flatness adjustment.



---

## Utilities

---

### 1. Front Panel Emulation

#### Description

This utility simulates an 8360 series instrument front panel keyboard in an instrument with a delete front panel option installed.

#### Procedure

To access the front panel emulation utility, select the front panel emulation program in the test menu.

The front panel emulation program cannot run front panel functions that use a power meter or printer. These functions cause the 8360 series instrument to act as a controller, which conflicts with the computer as the controller on the bus. Use a substitute front panel to run these functions, or use the tests provided with this software.

When using the front panel emulation program, enter the letter directly above the caret (^) to activate the function or key. Note that the keys are case sensitive ("L" means "ALC" and "I" means "LOCAL"). See Table 4-4 for a detailed listing of hardkey designations.

For numeric entry, two different terminator keys are combined on one hardkey. The actual terminator depends on the active mode of the synthesizer.

For example: When pulse width is the active entry, **10** **k** enters 10 ms. When frequency span is the active entry, **10** **k** enters 10 kHz.

Softkeys are designated by menukey X, where X is 1 through 5 and corresponds to the five softkey positions below the display. To activate the softkey, press the function key on the keyboard that corresponds to the number X indicated by menukey.

Table 4-4. Synthesizer Hardkey Emulation

Hardkey	Program Display	To Activate Select
MENU SELECT		
MOD	mod	m
ALC	aLc	L
MARKER	mrK	K
USER CAL	cal	c
SERVICE	Srv	S
PRIOR	Prior	P
SYSTEM		
SAVE	saVe	V
RECALL	Rcl	R
MENU	meNu	N
USER DEFINED		
MENU	menU	U
ASSIGN	asgn	a
ENTRY		
ENTRY ON/OFF	entry off	f
GHz/dB(m)	GHz/dBm	G
MHz/usec	MHz/uS	M
kHz/msec	kHz/mS	k
Hz.sec/ENTER	Hz/ENT	H

Table 4-4. Synthesizer Hardkey Emulation (continued)

Hardkey	Program Display	To Activate Select
SWEEP		
SWEEP TIME	Time	T
SINGLE	sIng	I
CONT	cOnt	O
MENU	mEnu	E
FREQUENCY		
CW	cW	W
START	stArt	A
STOP	stop	o
CENTER	Cent	C
SPAN	span	n
MENU	menu	u
POWER		
POWER LEVEL	level	v
FLTSNESS ON/OFF	flAt	t
RF ON/OFF	on/oFf	F
MENU	menu	e
INSTRUMENT STATE		
PRESET	preset	r
LOCAL	local	l

---

## 2. Calibration Constants

### Description

The calibration constants utility provides a variety of ways to manipulate the calibration constants stored in the instrument.

Use this utility to print out a list of the calibration constants stored in the instrument, to make a back-up of the calibration constants, and to restore calibration constants from a backed-up file.

### Procedure

Enter the password to allow access to the calibration constants by running the front panel emulation program provided with this software. See the "Calibration Constants" tab in this manual for information on accessing the calibration constants with the password.

You may need to perform several steps to reach your final goal. For example, to move the calibration constants from the instrument's working memory to a disk for back-up, you must first move them to the computer memory, and then from computer memory to disk. To store the calibration constants, you may use the hard disk drive, Disk 2 of your working disks, or a separate data disk. When storing data on a new disk, be sure to format the disk before you begin the utility.

Select the calibration constants entry in the test menu and follow the prompts.

---

### 3. Self-Test

#### Description

This utility is executed using the front panel emulation program. A full self-test of the synthesizer will be executed and the results displayed on the computer.

---

### 4. Power Sensor Configuration and Calibration Factor File

#### Description

This utility is used for creating and editing the files that store power sensor calibration factors. The power sensor calibration factors are used in the “Power Flatness” and “Step Attenuator” performance tests and adjustment procedures. This data can be stored to the directory or disk for future use. The power meter/power sensor configuration utility is used to define which power sensors, by serial number, are actually used when the automated test is run. Although you may enter and store calibration factors for several power sensors, the program will use only the power sensors that you have identified by serial number in the configuration utility.

#### Procedure

1. Select the “Power Flatness and Accuracy” test.
2. Select the HELP softkey to run the power sensor utility.

The following menu choices are displayed:

**Calco Utility**

Not used.

**Pmtr Config**

This is the power meter configuration utility. Use it to enter serial numbers for the power sensors which are listed in the “Sensor ID” column. For example, when the program requires an HP 8487D power sensor, it will

use the calibration factor data that is stored for whichever power sensor has been listed in the "Serial" column. If HP 8487A/D power sensors are used to test synthesizers with maximum stop frequencies of  $\geq 26.5$  GHz, enter their serial numbers for the HP 8485A/D choices. The "Sensor ID" and "Name" columns identify the frequency range and power level over which the power sensor is used. The HP 8487A/D can substitute for an HP 8485D; however, the reverse is not true.

After you select a power sensor, move the arrow to "Serial Number" and enter the new serial number. Then select DONE.

When the power meter configuration is correct, scroll down to selection 17 and save the configuration data.

#### **Pmtr Cal Factors**

This is the power meter calibration factor utility. Use it to enter and store calibration factors for each power sensor. Notice that the test software requires calibration factors at 50 MHz and at one frequency higher than the specified stop frequency of the synthesizer under test.

To edit or enter new calibration factors, select the serial number for the power sensor from the displayed list. (This list is derived from the power meter configuration utility and the power sensor must already be entered in the configuration.) The calibration factors which were previously stored will be loaded and the editing menu will be displayed.

**Note:** If a calibration factor data file does not yet exist for the serial number selected, select ABORT and OK to access the menu for entering the calibration factors.

The following menu choices will allow you to enter and store calibration factors:

**Edit Cal Factors:** Use this selection only if a few calibration factors need to be edited. For extensive changes, use "Serial Entry". After making all edits, select "Store Cal Factors" to save the data.

**Edit Sensor Info:** Not used.

**Load Cal Factors:** Use this selection to load the calibration factor data file of the "Current" power sensor from disk or directory specified in the MSI command.

---

**Store Cal Factors:** Use this selection to store the calibration factors of the "Current" power sensor to the disk or directory specified in the MSI command.

**Current:** This selection identifies the current power sensor (the power sensor selected for editing and storing calibration factors). Entering another serial number changes the current power sensor to the power sensor of the new serial number.

**Serial Entry:** Use this selection to create new calibration factor data for the current power sensor. To indicate the last entry, enter "0,0". After making all entries, select "Store Cal Factors" to save the data.

3. When the power meter configuration is correct and the calibration factors have been entered, select DONE to exit the utility.



HEWLETT  
PACKARD

# INSTRUMENT SYSTEM

## Software Support Request

SUBMITTED BY (SYSTEM MANAGER)		PHONE	EXTENSION	DATE	CUSTOMER REFERENCE *
COMPANY NAME		SYSTEM MODEL		SERIAL #	
DEPARTMENT/DIVISION/BUILDING	SOFTWARE PRODUCT INFORMATION	NAME			
ADDRESS		NUMBER			
		REVISION CODE			
<b>CONFIGURATION</b> (Include the minimum hardware, software and firmware on which the problem occurs. This should include applicable options, date code and revision, etc.)					
<b>PROBLEM DESCRIPTION</b> (Include environment, symptom, what you were trying to do, what went wrong, and any other information that might be helpful.)					
<b>DOCUMENTATION</b> (List all the supportive documentation included with this report. You must provide all relevant programs, data lines, data bases, etc. Please label the media.)					
<b>MEDIA</b>	<b>DESCRIPTION</b>				
_____	_____				
_____	_____				
_____	_____				

9320-5327

Return this form to your local HP Sales Office, Attn: Instrument SEDM

HP 8360

Automated Tests







HEWLETT  
PACKARD

# INSTRUMENT SYSTEM

## Software Support Request

SUBMITTED BY (SYSTEM MANAGER)		PHONE	EXTENSION	DATE	CUSTOMER REFERENCE #
COMPANY NAME		SYSTEM MODEL		SERIAL #	
DEPARTMENT/DIVISION/BUILDING	SOFTWARE PRODUCT INFORMATION	NAME			
ADDRESS		NUMBER			
		REVISION CODE			
<b>CONFIGURATION</b> (Include the minimum hardware, software and firmware on which the problem occurs. This should include applicable options, date code and revision, etc.)					
<b>PROBLEM DESCRIPTION</b> (Include environment, symptom, what you were trying to do, what went wrong, and any other information that might be helpful.)					
<b>DOCUMENTATION</b> (List all the supportive documentation included with this report. You must provide all relevant programs, data lines, data bases, etc. Please label the media.)					
<b>MEDIA</b>	<b>DESCRIPTION</b>				
_____	_____				
_____	_____				
_____	_____				

9320-5327

Return this form to your local HP Sales Office. Attn: Instrument SEDM

HP 8360

Automated Tests





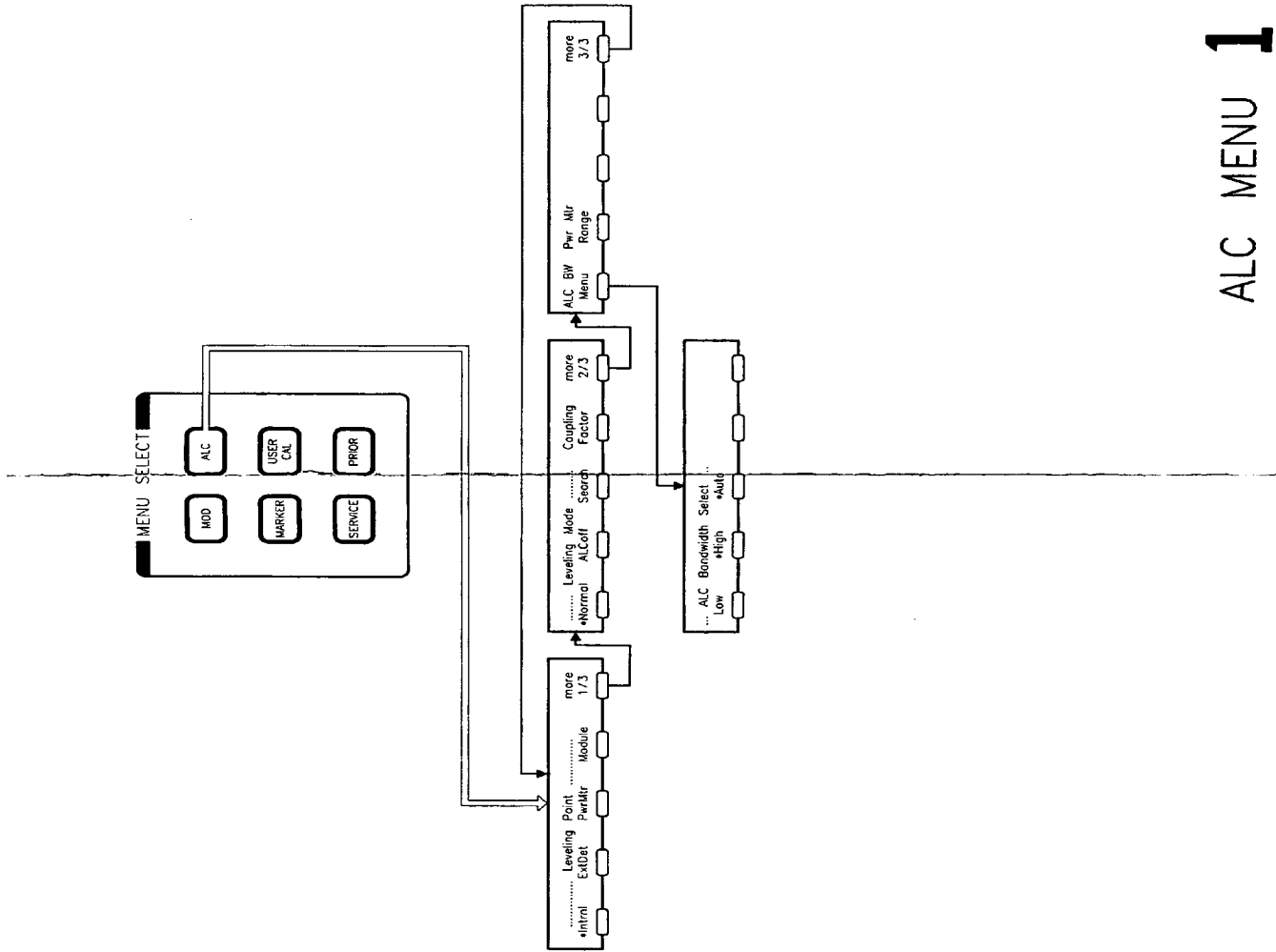

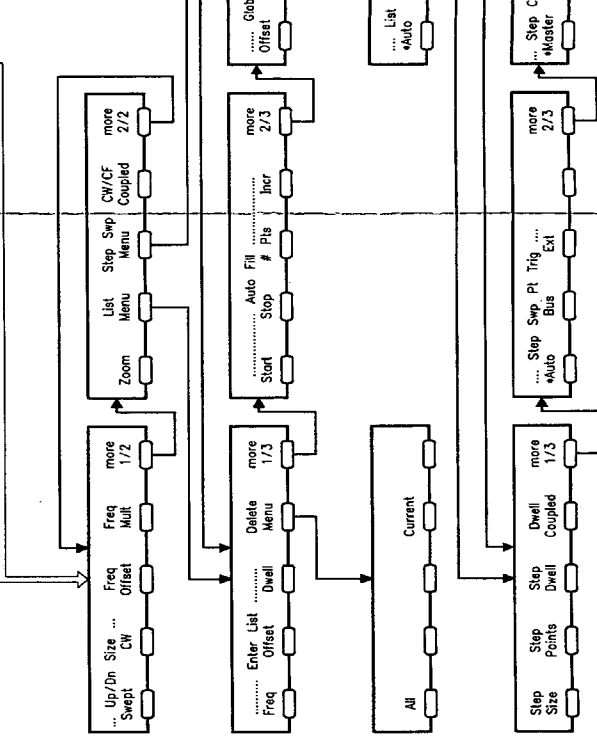
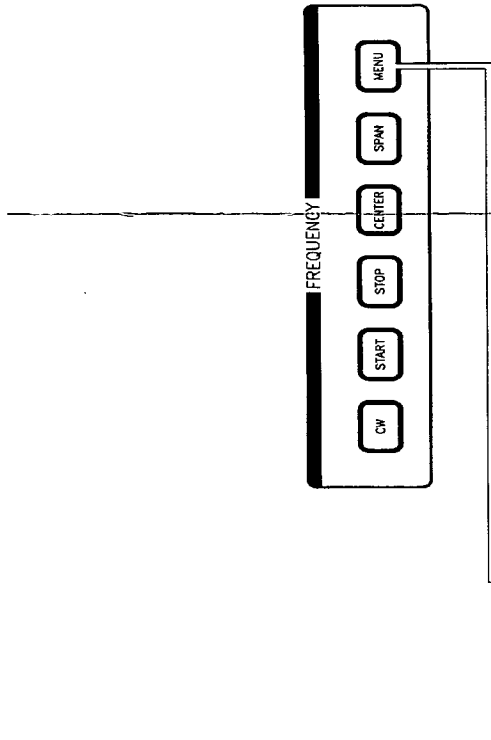

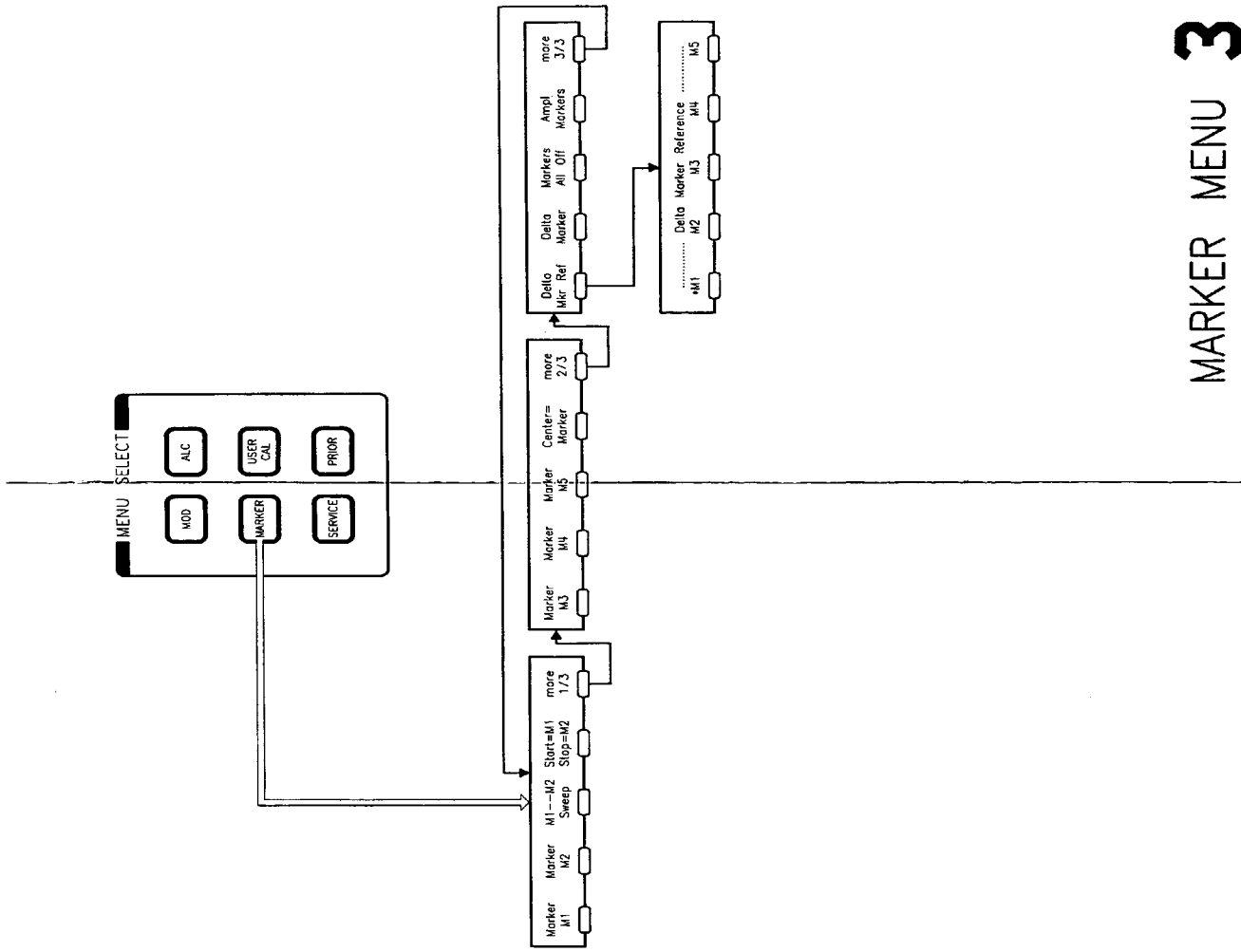

# MARKER MENU 3

# OPTION 002 MENU

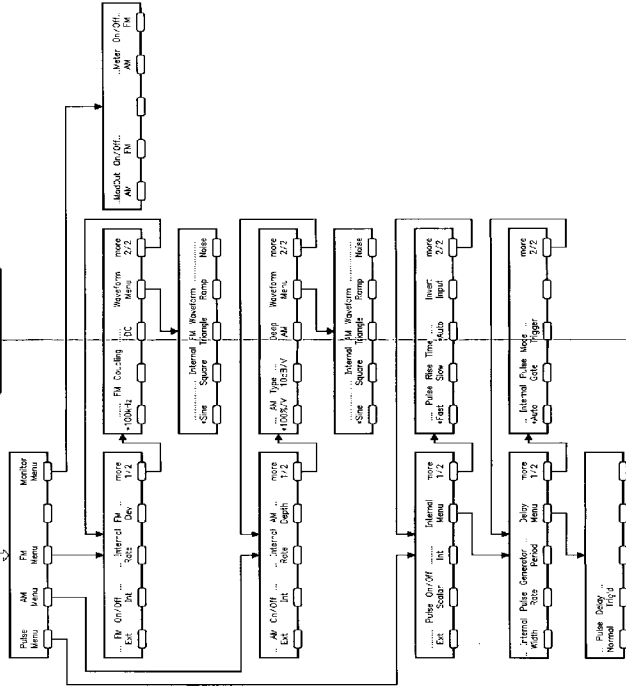
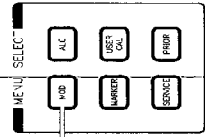

# MODULATION MENU 4

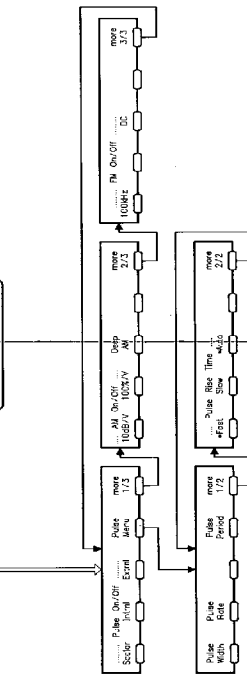
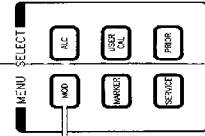



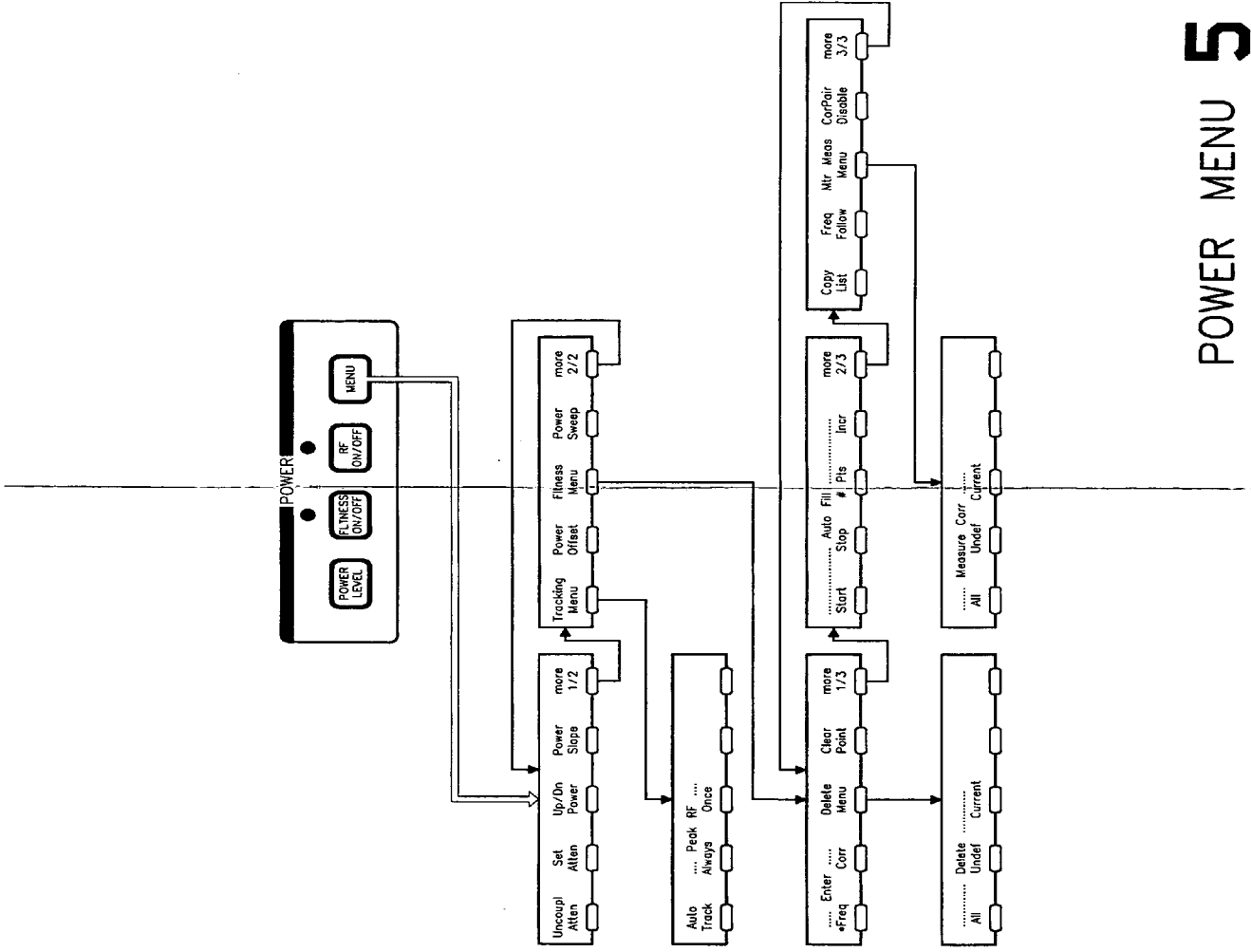





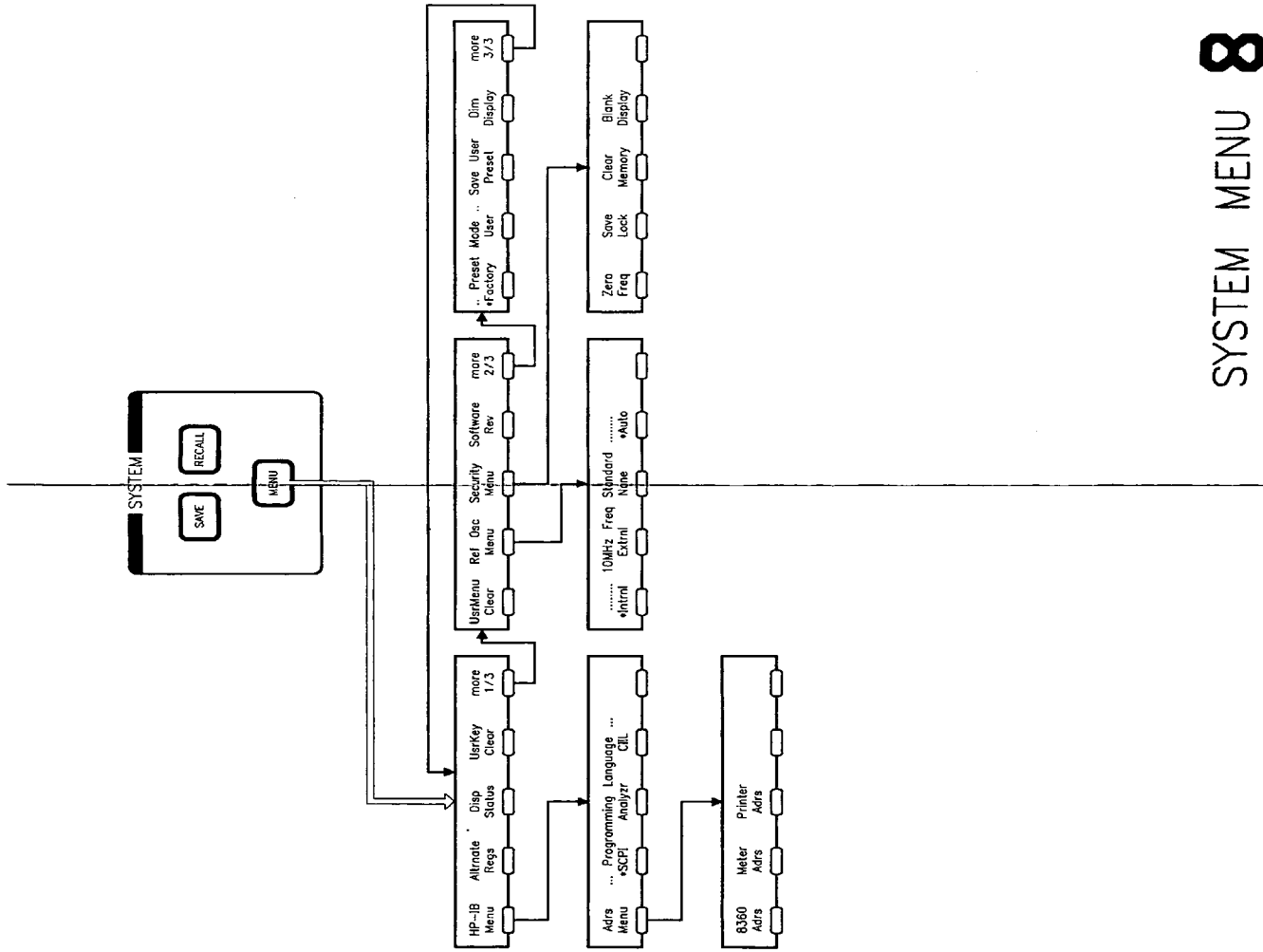

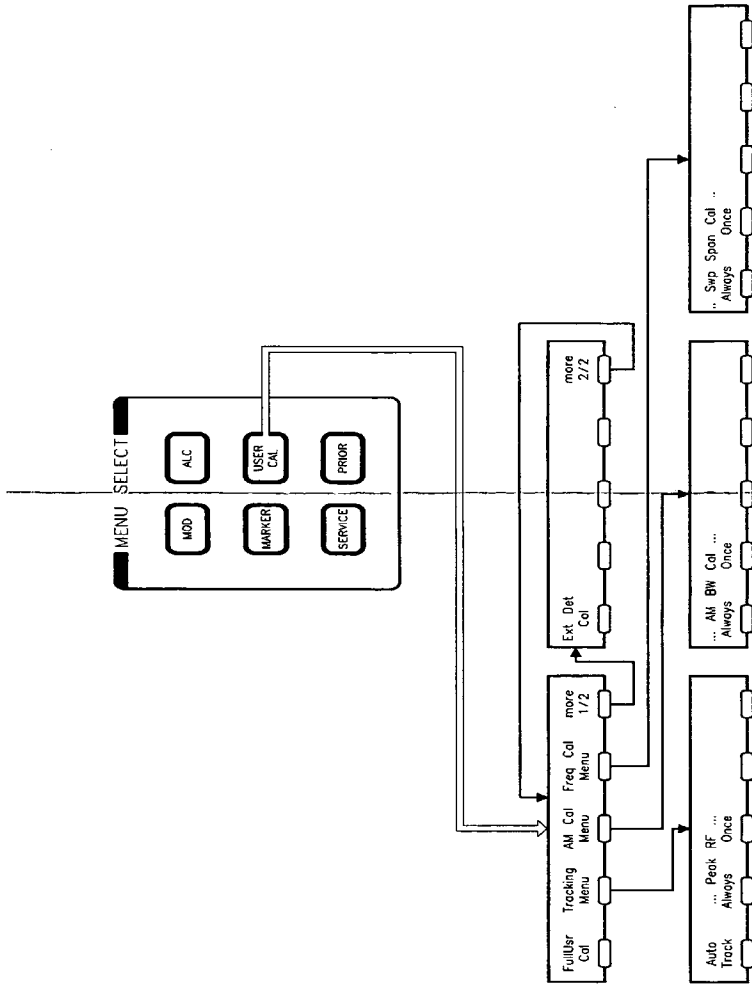

GLOSSARY

## GLOSSARY

**ADC:** Analog-to-Digital Converter.

**ALC:** Automatic Leveling Control.

**API:** Analog Phase Interpolator.

**EEPROM:** Electrically Erasable Programmable Read-Only Memory.

**factory preset:** The factory-set standard starting configuration of the synthesizer when **PRESET** is pressed.

**quadrature:** A 90° offset between mixer inputs.

**squegg:** A distortion in the RF output caused by too much power to the SYTM and characterized by a power dropout in a portion of the trace or a power dropout over a broad frequency range.

**SRD:** Step Recovery Diode.

**SYTM:** Switched YIG-Tuned Oscillator.

**UVEPROM:** Ultraviolet Erasable Programmable Read-Only Memory.

**VCO:** Voltage Controlled Oscillator

**YO:** YIG (Yttrium-Iron-Garnate) Oscillator.





## INDEX

10 MHz standard adjustment. <i>see</i> adjustments	
<b>A</b>	
ADC adjustment. <i>see</i> automated adjustments	
adjustments	3-2
10 MHz standard	3-3
ALC power level accuracy	3-87
AM accuracy	3-95
AM delay	3-99
AM input impedance	3-111
amplifier detector gain	3-81
amplifier detector offset	3-27
automated. <i>see</i> automated adjustments	
FM gain	3-105
FM input impedance	3-113
fractional-N VCO	3-7
fractional-N reference and API spurs	3-9
low power SRD bias	3-77
modulation generation flatness	3-115
modulator offset and gain	3-83
power flatness	3-91
pulse delay	3-101
sampler assembly	3-15
IF gain	3-17
200 MHz loop gain	3-17
200 MHz loop VCO tune	3-16
sampler match	3-17
VCO fixed trim capacitor selection	3-19
square wave symmetry	3-109
sweep ramp	3-13
SYTM adjustments	3-29
SYTM adjustments, Opt. 006	3-53
YO driver + 10V reference	3-21
YO driver gain and linearity	3-23
YO loop gain	3-25
aging rate	2-5
ALC power level accuracy adjustment. <i>see</i> adjustments	
AM accuracy adjustment. <i>see</i> adjustments	
AM accuracy performance test. <i>see</i> performance tests	
AM bandwidth performance test. <i>see</i> performance tests	
AM delay adjustment. <i>see</i> adjustments	
AM dynamic range performance test. <i>see</i> performance tests	
amplifier detector gain adjustment. <i>see</i> adjustments	
amplifier detector offset adjustment. <i>see</i> adjustments	
automated adjustments	
ADC	4-14
power flatness	4-15
step attenuator flatness	4-12
YO delay	4-14
automated performance tests	
power flatness and accuracy	4-10
step attenuator flatness	4-8
automated tests	4-1
installing the software	4-3
running the software	4-5
utilities	4-17
front panel emulation	4-17
calibration constants	4-20
self-test	4-21
power sensor configuration and calibration factor file	4-21
<b>C</b>	
calibration constants	3-119; <i>see also</i> automated tests
descriptions	3-126
calibration cycle	2-2
checksum verification	3-121
<b>D</b>	
delay line discriminator	2-85
<b>E</b>	
equipment required	1-1
external leveling performance test. <i>see</i> performance tests	
<b>F</b>	
FM accuracy performance test. <i>see</i> performance tests	
FM bandwidth performance test. <i>see</i> performance tests	
FM gain adjustment. <i>see</i> adjustments	
fractional-N VCO adjustment. <i>see</i> adjustments	
fractional-N reference and API spurs adjustment. <i>see</i> adjustments	
frequency switching time performance test. <i>see</i> performance tests	
<b>H</b>	
harmonics	2-31
<b>I</b>	
internal timebase	2-5, 3-3
internal timebase: aging rate performance test. <i>see</i> performance tests	
<b>L</b>	
low power SRD bias adjustment. <i>see</i> adjustments	
<b>M</b>	
maximum FM deviation performance test. <i>see</i> performance tests	
maximum leveled power performance test. <i>see</i> performance tests	
modulator offset and gain adjustment. <i>see</i> adjustments	
<b>O</b>	
operation verification	2-107
form	2-109
ordering manuals	ii
<b>P</b>	
password	3-121
performance tests	2-1
AM accuracy	2-65
AM bandwidth	2-69
AM dynamic range	2-73

deep AM dynamic range ..... 2-76  
 internal AM dynamic range (Option 002) ..... 2-75  
 internal deep AM dynamic range (Option 002) ... 2-78  
 normal AM dynamic range ..... 2-74  
 automated. *see* automated performance tests  
 external leveling ..... 2-29  
 FM accuracy ..... 2-81  
 FM bandwidth ..... 2-85  
   DC FM flatness (unlocked) ..... 2-87  
   find quadrature ..... 2-87  
 frequency switching time ..... 2-13  
   CW ..... 2-14  
   frequency list ..... 2-16  
   stepped sweep ..... 2-15  
 internal pulse accuracy  
   (Option 002) ..... 2-95  
 internal timebase: aging rate ..... 2-5  
 maximum FM deviation ..... 2-89  
   AC FM (at 100 kHz) ..... 2-92  
   DC FM (100 ≤ Hz) ..... 2-89  
   internal DC FM (< = 100 Hz) (Option 002) ..... 2-91  
   internal AC FM (at 100 kHz) (Option 002) ..... 2-94  
 maximum leveled power ..... 2-25  
 modulation meter (Option 002) ..... 2-97  
 power accuracy ..... 2-19  
 power flatness ..... 2-23  
 pulse modulation on/off ratio ..... 2-49  
 pulse modulation video feedthrough ..... 2-59  
   high band video feedthrough ..... 2-64  
   low band video feedthrough ..... 2-61  
   video gain ..... 2-60  
 pulse performance ..... 2-53  
   rise and fall times ..... 2-53  
   pulse leveling accuracy ..... 2-56  
 single sideband phase noise ..... 2-43  
   alternate procedure ..... 2-47  
   spurious signals (harmonic) ..... 2-31  
     harmonic/subharmonic verification ..... 2-33  
   spurious signals (line-related) ..... 2-39  
   spurious signals (non-harmonic) ..... 2-35  
     fixed spurious signals ..... 2-35  
     low band spurious signals ..... 2-37  
   swept frequency accuracy ..... 2-9  
 power accuracy performance test. *see* performance tests  
 power flatness adjustment. *see* adjustments;  
   automated adjustments  
 power flatness performance test. *see* performance tests  
 power flatness and accuracy performance test.  
   *see* automated performance tests  
 prefix. *see* serial number  
 pulse delay adjustment. *see* adjustments  
 pulse modulation video feedthrough performance test.  
   *see* performance tests  
 pulse performance performance test.  
   *see* performance tests

## Q

quadrature. *see* performance tests, FM bandwidth

## S

sampler assembly adjustment.  
   *see* adjustments  
 serial number ..... i  
 single sideband phase noise performance test.  
   *see* performance tests  
 software, automated tests. *see* automated tests  
 software support request ..... 4-21  
 spurious signals (harmonic) performance test. *see*  
   performance tests  
 spurious signals (line-related) performance test.  
   *see* performance tests  
 spurious signals (non-harmonic) performance test.  
   *see* performance tests  
 square wave symmetry adjustment. *see* adjustments  
 step attenuator flatness adjustment.  
   *see* automated adjustments  
 step attenuator flatness performance test.  
   *see* automated performance tests  
 subharmonics ..... 2-31  
 sweep ramp adjustment. *see* adjustments  
 swept frequency accuracy performance test.  
   *see* performance tests  
 SYTM adjustments. *see* adjustments

## T

test record ..... 2-99

## U

user flatness correction array ..... 2-23

## V

VCO fixed trim capacitor selection.  
   *see* adjustments, sampler assembly  
 verification. *see* operation verification  
 video feedthrough. *see* performance tests,  
   pulse modulation video feedthrough

## Y

YO delay adjustment. *see* automated adjustments  
 YO driver +10V reference adjustment. *see* adjustments  
 YO driver gain and linearity adjustments. *see* adjustments  
 YO loop gain adjustment. *see* adjustments

**INSTRUMENT HISTORY**



# Instrument History

---

## Introduction

This manual documents the versions of the HP 8360 Series Synthesized Sweepers having the serial prefixes listed on the title page of this manual. Earlier versions of these instruments may have differences which are documented in the *HP 8360 Series Synthesized Sweepers Instrument History* (to order, see "Replaceable Parts" in *Assembly-Level Repair*).

With the information provided in this section, this manual can be adapted to apply to any of the versions listed on the title page.

---

## How to Use Instrument History

Find the serial prefix number of your instrument in the following table. Make the changes that are listed for that prefix. The actual changes, with instructions, are on the following pages.

**Note:** Incorporate the backdating changes in reverse alphabetical order. For example: your instrument has serial number prefix 3036A. Make Change E first, then make Changes D, C, B, and A.

### HP 83620A/22A Instrument History Changes

Serial Prefix Number	Change
3119A	No Change Needed
3108A	E
3104A	E, D
3102A	E, D, C
3050A	E, D, C
3044A	E, D, C, B
3036A	E, D, C, B, A

---

#### HP Internal Use Only

PCO 3036:09813/3044:10001/3050:09759/3102:09845/3104:09997/3108:09966,10378/3119:101

---

## Change E

No changes are required for this *Calibration* manual. The instructions for this change are in another volume in your manual set. Refer to the “Instrument History” chapter in each volume of your manual set.

---

## Change D

No changes are required for this *Calibration* manual. The instructions for this change are in another volume in your manual set. Refer to the “Instrument History” chapter in each volume of your manual set.

---

## Change C

No changes are required for this *Calibration* manual. The instructions for this change are in another volume in your manual set. Refer to the “Instrument History” chapter in each volume of your manual set.



---

## Change B

● No changes are required for this *Calibration* manual. The instructions for this change are in another volume in your manual set. Refer to the “Instrument History” chapter in each volume of your manual set.

---

## Change A

No changes are required for this *Calibration* manual. The instructions for this change are in another volume in your manual set. Refer to the "Instrument History" chapter in each volume of your manual set.

ck FD Rom

Dim Id \$ [100]

Output 719; "IDN?"

ENTER 919; Id \$

PRINT Id \$

END