

Keysight Series 657xA and 667xA GPIB DC Power Supplies

Service Manual

NOTICE: This document contains references to Agilent Technologies. Agilent's former Test and Measurement business has become Keysight Technologies. For more information, go to www.keysight.com.



CERTIFICATION

Keysight Technologies certifies that this product met its published specifications at time of shipment from the factory. Keysight Technologies further certifies that its calibration measurements are traceable to the United States National Bureau of Standards, to the extent allowed by the Bureau's calibration facility, and to the calibration facilities of other International Standards Organization members.

WARRANTY

This Keysight Technologies hardware product is warranted against defects in material and workmanship for a period of three years from date of delivery. Keysight Technologies software and firmware products, which are designated by Keysight Technologies for use with a hardware product and when properly installed on that hardware product, are warranted not to fail to execute their programming instructions due to defects in material and workmanship for a period of 90 days from date of delivery. During the warranty period Keysight Technologies will, at its option, either repair or replace products which prove to be defective. Keysight Technologies does not warrant that the operation of the software, firmware, or hardware shall be uninterrupted or error free.

For warranty service, with the exception of warranty options, this product must be returned to a service facility designated by Keysight Technologies. Customer shall prepay shipping charges by (and shall pay all duty and taxes) for products returned to Keysight Technologies for warranty service. Except for products returned to Customer from another country, Keysight Technologies shall pay for return of products to Customer.

Warranty services outside the country of initial purchase are included in Keysight Technologies product price, only if Customer pays Keysight Technologies international prices (defined as destination local currency price, or U.S. or Geneva Export price).

If Keysight Technologies is unable, within a reasonable time to repair or replace any product to condition as warranted, the Customer shall be entitled to a refund of the purchase price upon return of the product to Keysight Technologies.

LIMITATION OF WARRANTY

The foregoing warranty shall not apply to defects resulting from improper or inadequate maintenance by the Customer, Customer-supplied software or interfacing, unauthorized modification or misuse, operation outside of the environmental specifications for the product, or improper site preparation and maintenance. **NO OTHER WARRANTY IS EXPRESSED OR IMPLIED. KEYSIGHT TECHNOLOGIES SPECIFICALLY DISCLAIMS THE IMPLIED WARRANTIES OF MERCHANTABILITY AND FITNESS FOR A PARTICULAR PURPOSE.**

EXCLUSIVE REMEDIES

THE REMEDIES PROVIDED HEREIN ARE THE CUSTOMER'S SOLE AND EXCLUSIVE REMEDIES. KEYSIGHT SHALL NOT BE LIABLE FOR ANY DIRECT, INDIRECT, SPECIAL, INCIDENTAL, OR CONSEQUENTIAL DAMAGES, WHETHER BASED ON CONTRACT, TORT, OR ANY OTHER LEGAL THEORY.

ASSISTANCE

The above statements apply only to the standard product warranty. Warranty options, extended support contracts, product maintenance agreements and customer assistance agreements are also available. Contact your nearest Keysight Technologies Sales and Service office for further information on Keysight Technologies' full line of Support Programs.

SAFETY CONSIDERATIONS

GENERAL. This is a Safety Class 1 instrument (provided with terminal for connection to protective earth ground).

OPERATION. BEFORE APPLYING POWER verify that the product is set to match the available line voltage, the correct line fuse is installed, and all safety precautions (see following warnings) are taken. In addition, note the instrument's external markings described under "Safety Symbols".

WARNING.

- Servicing instructions are for use by service-trained personnel. To avoid dangerous electrical shock, do not perform any servicing unless you are qualified to do so.
- BEFORE SWITCHING ON THE INSTRUMENT, the protective earth terminal of the instrument must be connected to the protective conductor of the (mains) power cord. The mains plug shall be inserted only in an outlet socket that is provided with a protective earth contact. This protective action must not be negated by the use of an extension cord (power cable) that is without a protective conductor (grounding). Grounding one conductor of a two-conductor outlet is not sufficient protection.
- If this instrument is to be energized via an auto-transformer (for voltage change), make sure the common terminal is connected to the earth terminal of the power source.
- Any interruption of the protective (grounding) conductor (inside or outside the instrument), or disconnecting of the protective earth terminal will cause a potential shock hazard that could result in personal injury.
- Whenever it is likely that the protective earth connection has been impaired, this instrument must be made inoperative and be secured against any unintended operation.
- Only fuses with the required rated current, voltage, and specified type (normal blow, time delay, etc.) should be used. Do not use repaired fuses or short-circuited fuseholders. To do so could cause a shock or fire hazard.
- Do not operate this instrument in the presence of flammable gases or fumes.
- Do not install substitute parts or perform any unauthorized modification to this instrument.
- Some procedures described in this manual are performed with power supplied to the instrument while its protective covers are removed. If contacted, the energy available at many points may result in personal injury.
- Any adjustment, maintenance, and repair of this instrument while it is opened and under voltage should be avoided as much as possible. When this is unavoidable, such adjustment, maintenance, and repair should be carried out only by a skilled person who is aware of the hazard involved.
- Capacitors inside this instrument may hold a hazardous electrical charge even if the instrument has been disconnected from its power source.

SAFETY SYMBOLS.



This symbol indicates that the instrument will be marked with this symbol when it is necessary for you to refer to the instruction manual in order to protect against damage to the instrument.



This sign indicates hazardous voltages.

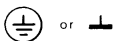



















This sign indicates an earth terminal (sometimes used in the manual to indicate circuit common connected to a ground chassis).

WARNING

The WARNING sign denotes a hazard. It calls attention to a procedure, practice, or the like, which, if not correctly performed or adhered to, could result in personal injury. Do not proceed beyond a WARNING sign until the indicated conditions are fully understood and met.

CAUTION

The CAUTION sign denotes a hazard. It calls attention to an operating procedure, or the like, which, if not correctly performed or adhered to, could result in damage to or destruction of part or all of the product. Do not proceed beyond a CAUTION sign until the indicated conditions are fully understood and met.

Safety Symbol Definitions			
Symbol	Description	Symbol	Description
	Direct current		Terminal for Line conductor on permanently installed equipment
	Alternating current		Caution, risk of electric shock
	Both direct and alternating current		Caution, hot surface
	Three-phase alternating current		Caution (refer to accompanying documents)
	Earth (ground) terminal		In position of a bi-stable push control
	Protective earth (ground) terminal (Intended for connection to external protective conductor.)		Out position of a bi-stable push control
	Frame or chassis terminal		On (supply)
	Terminal for Neutral conductor on permanently installed equipment		Off (supply)
	Terminal is at earth potential (Used for measurement and control circuits designed to be operated with one terminal at earth potential.)		Standby (supply) Units with this symbol are not completely disconnected from ac mains when this switch is off. To completely disconnect the unit from ac mains, either disconnect the power cord or have a qualified electrician install an external switch.

Printing History

The edition and current revision of this manual are indicated below. Reprints of this manual containing minor corrections and updates may have the same printing date. Revised editions are identified by a new printing date. A revised edition incorporates all new or corrected material since the previous printing date. Changes to the manual occurring between revisions are covered by change sheets shipped with the manual. Also, if the serial number prefix of your power supply is higher than those listed on the title page of this manual, then it may or may not include a change sheet. That is because even though the higher serial number prefix indicates a design change, the change may not affect the content of the manual.

Edition 1 October 1993
Edition 2 September, 2000
Edition 3 December, 2014

© Copyright 1993, 2000, 2014 Keysight Technologies

This document contains proprietary information protected by copyright. All rights are reserved. No part of this document may be photocopied, reproduced, or translated into another language without the prior consent of Keysight Technologies. The information contained in this document is subject to change without notice.

Table of Contents

Introduction	7
Scope	7
Organization.....	7
Related Documents	7
Change Sheet.....	7
Operating Manual.....	7
Instrument Identification.....	8
Manual Revisions.....	8
Firmware Revisions.....	8
Safety Considerations	8
Conventions	9
Electrostatic Discharge	9
Verification.....	11
Introduction.....	11
Tests.....	11
Test Equipment Required.....	11
List of Equipment.....	11
Current-Monitoring Resistor	11
Electronic Load.....	12
Programming The Tests	13
General Considerations	13
Programming Parameters	13
General Measurement Techniques	13
Performance Test Record Sheets	13
Operation Verification Tests.....	14
Performance Tests.....	15
Constant Voltage (CV) Tests	15
Test Setup.....	15
Test Procedures	15
Constant Current (CC) Tests	19
Test Setup.....	19
Test Procedures	19
Averaging the CC Measurements.....	22
Troubleshooting.....	29
Introduction.....	29
Localizing the Problem	29
Chapter Organization	29
Test Equipment Required.....	30
Troubleshooting Procedures	30
Power-On Selftest	30
Description	30
Disabling The Power-On Selftest.....	30
Using the *TST? Query (GPIB Systems Supplies Only)	30
Troubleshooting Charts.....	32
Troubleshooting Test Points	32
Bias and Reference Supplies.....	32
CV/CC Status Annunciators Troubleshooting.....	53
A5 Control Board Troubleshooting Setup	53
A3 FET Board Troubleshooting	53
Signature Analysis	56
Introduction.....	56
Firmware Revisions.....	56
Test Headers	56

Post-Repair Calibration	63
When Required	63
Inhibit Calibration Jumper	63
Calibration Password	63
Restoring Factory Calibration Constants	63
EEPROM Initialization.....	64
Transferring Calibration Constants To Factory Preset Locations	64
Disassembly Procedures	69
Top Cover	69
RFI Shield.....	69
Front Panel Assembly.....	70
S1 Line Switch.....	70
A1 Front Panel Board.....	70
A1DSP1 LCD Display.....	70
A1G1 and A1G2 Rotary Controls	70
A1KPD Keypad.....	71
Rear Panel and/or A2 GPIB or Isolator Board	71
Output Subchassis.....	71
A5 Control Board	71
A6 Output Filter Board.....	72
A7 Snubber Board and D900 Output Rectifier.....	72
T900 Output Power Transformer/L900 Output Choke.....	72
AC Input Filter.....	72
A3 FET Board and Heatsink Assembly.....	73
A4 AC Input Board.....	74
B1 Fan	74
Principles of Operation.....	77
Introduction	77
INTERFACE CONTROL CIRCUITS	77
A2 GPIB Board (667xA Series Only)	77
A2 Isolator Board Circuits (657xA Series Only).....	78
A1 Front Panel Assembly.....	78
A5 Control Board	79
Secondary Interface	79
CV/CC Control	80
Switching/Downprogramming Control	80
Power Circuits	81
A4 AC Input Board.....	81
Input Filter and Rectifier.....	81
Bias Supplies and Bias Detect	81
Fan Speed Control	81
A3 FET Board	82
Output Circuits	82
Replaceable Parts	85
INTRODUCTION.....	85
Chapter Organization.....	85
Reading the Tables	85
How To Order Parts	86
Diagrams	117
Introduction	117
Chapter Organization.....	117
General Schematic Notes.....	123
Backdating	145
Index.....	155

Introduction

Scope

Organization

This manual contains information for troubleshooting and repairing to the component level the following 2-kilowatt power supplies.

- Keysight Series 657xA manually programmable (bench), and
- Keysight Series 667xA GPIB programmable (system) supplies.

The remaining chapters of this manual are organized as follows:

Chapter	Description
Chapter 2	Verification procedures to determine the performance level of the supply either before or after repair.
Chapter 3	Troubleshooting procedures for isolating a problem, procedures for replacing the defective component and, if required, post-repair calibration and EEPROM initialization procedures.
Chapter 4	Principles of power supply operation on a block-diagram level.
Chapter 5	Replaceable parts, including parts ordering information.
Chapter 6	Diagrams, including schematics, component location drawings, and troubleshooting test points.
Appendix A	Backdating information for power supplies with serial numbers below those listed in the title page of this manual.

Related Documents

Change Sheet

There may or may not be a *Manual Change* sheet included with this manual (see Manual Revisions). If one is included, be sure to examine it for changes to this manual.

Operating Manual

Each power supply is shipped with an operating manual (see Replaceable Parts, Chapter 5 for part numbers) that covers the following topics:

- Options, accessories, specifications, supplementary characteristics, output characteristic curve, typical output impedance curves.
- Connecting the power cord, load, and remote sensing.
- Connecting power supplies in series or autoparallel.
- Connecting the remote controller and setting the GPIB address.
- Configuring the digital port for remote inhibit, relay link, or digital I/O operation.
- Connecting the analog port for external voltage programming control.
- Turn-on tests, including selftest errors and runtime errors.
- Front panel operation.
- SCPI programming, an introduction to syntax, language dictionary, and status register operation.
- Compatibility-language programming for operation with Keysight Series 603xA power supplies.
- Replacement of line fuse and conversion of line voltage.
- Calibration procedure (front panel and remote).

Instrument Identification

The power supply is identified by a unique, two-part serial number, such as, US36320101. The items in this serial number are explained as follows:

Item	Description
US	Indicates the country of manufacture, where US = USA.
3643	The year and week of manufacture or last significant design change. Add 1960 to the first two digits to determine the year. For example, 36=1996. The last two digits specify the week of the year.
0101	A sequential number assigned to each power supply.

Manual Revisions

This manual was written for power supplies that have the same serial prefixes (first part) as those listed on the title page and whose serial numbers (second part) are equal to or higher than those listed in the title page.

Note	<ol style="list-style-type: none">1) If the serial prefix of your supply is higher than that shown in the title page then the supply was made after the publication of this manual and may have hardware and/or firmware differences not covered in the manual.2) If they are significant to the operation and/or servicing of the power supply, those differences are documented in one or more <i>Manual Changes</i> sheets included with this manual.3) If the serial prefix on the power supply is lower than that shown on the title page, then the supply was made before the publication of this manual and can be different from that described here. Such differences are covered in Appendix A - Manual Backdating Changes.
-------------	---

Firmware Revisions

The power supply's firmware resides in the main board microprocessor chip and in ROM chips on the A2 GPIB and A1 Front Panel boards. You can obtain the firmware revision number as follows:

- For a bench power supply, you will find the revision numbers printed on the label affixed to the integrated circuit.
- For a GPIB system power supply, you can read the integrated circuit label as above, or query the power supply using the GPIB *IDN query command (see Chapter 3 - Troubleshooting). Also, see Chapter 3, Firmware Revisions for the actual Keysight BASIC program that does this.

Safety Considerations

This power supply is a Safety Class I instrument, which means it has a protective earth terminal. This terminal must be connected to earth ground through a power source equipped with a 3-wire, ground receptacle. Refer to the "Safety Summary" page at the beginning of this manual for general safety information. Before operation or repair, check the power supply and review this manual for safety warnings and instructions. Safety warnings for specific procedures are located at appropriate places in the manual.

WARNING

Hazardous voltage exist within the power supply chassis, at the output terminals, and at the analog programming terminals.

Conventions

- In diagrams, the name of a complementary signal is sometimes shown with a bar above the signal mnemonic. In other diagrams and in the text, complementary signals are shown with an asterisk (*) after the mnemonic (such as PCLR*). A mnemonic with a bar over it or an asterisk after it represents the same signal.
- In this manual, all Keysight 667xA Series supplies are referred to as *system* supplies. All Keysight 657xA Series supplies are referred to as *bench* supplies.

Electrostatic Discharge

CAUTION

The power supply has components that can be damaged by ESD (electrostatic discharge). Failure to observe standard, antistatic practices can result in serious degradation of performance, even when an actual failure does not occur.

When working on the power supply observe all standard, antistatic work practices. These include, but are not limited to:

- Working at a static-free station such as a table covered with static-dissipative laminate or with a conductive table mat (Keysight P/N 9300-0797, or equivalent).
- Using a conductive wrist strap, such as Keysight P/N 9300-0969 or 9300-0970.
- Grounding all metal equipment at the station to a single common ground.
- Connecting low-impedance test equipment to static-sensitive components only when those components have power applied to them.
- Removing power from the power supply before removing or installing printed circuit boards.

Verification

Introduction

This chapter provides test procedures for checking the operation of Keysight Series 667xA GPIB (system) and 657xA programmable (bench) power supplies. The required test equipment is specified and sample performance test record sheets are included. Instructions are given for performing the tests either from the front panel or from a controller over the GPIB for system units.

Tests

Two types of procedures are provided: Operation Verification tests and Performance tests.

Type of Test	Purpose
Operation Verification	These tests do not check all parameters, but comprise a short procedure to verify that the power supply is performing properly.
Performance	These tests verify all the Specifications (not Supplementary Characteristics) listed in Table 1-1 of the Power Supply Operating Manual.

If you encounter failures or out-of-specification test results, see Troubleshooting Procedures (Chapter 3). The procedures will determine if repair and/or calibration is required.

Note The power supply must pass the selftest at power-on before the following tests can be performed. If the power supply fails selftest, go to Chapter 3.

Test Equipment Required

List of Equipment

Table 2-1 lists the equipment required to perform the tests given in this chapter. Only the equipment marked with the superscript ¹ is needed for the Operation Verification test.

Current-Monitoring Resistor

The four-terminal, current-monitoring resistor listed in Table 2-1 is required to eliminate output current measurement error caused by voltage drops in leads and connections. The specified load resistors have special current-monitoring terminals inside the load connection terminals. Connect the AC or DC voltmeter directly to these current-monitoring terminals.

Table 2-1. Test Equipment Required

Type	Required Characteristics	Recommended Model
Digital Voltmeter¹	Resolution: 10 nV @ 1V Readout: 8 1/2 digits Accuracy: 20 ppm	Keysight 3458A
Current Monitor Resistor¹	Keysight 6571A, 6671A: 0.001Ω ± 0.04%, 300A, 100W Keysight 6572A-6575A, 6672A-6675A 0.01Ω ± 0.04%, 100A, 100W	Guildline 9230/300 Guildline 9230/100
DC Power Supply	5V @10A	Keysight 6653A
Electronic Load	Range: Voltage and current range must exceed that of supply under test. Power: 2KW minimum Keysight 6571A-6574A, 6671A-6674A Keysight 6575A, 6675A	(1) Keysight 6050B, mainframe with (3) Keysight 6040A modules. (2) Keysight 6050B, mainframe with (3) Keysight 60507B modules plus (1) Keysight 6051A mainframe with (1) 60507B module.
Oscilloscope	Sensitivity: 1mV Bandwidth Limit: 20MHz Probe: 1:1 with RF tip	Keysight 54504A
RMS Voltmeter	True RMS Bandwidth: 20MHz Sensitivity: 100 μV	Keysight 3400B
Variable-Voltage Transformer	Power: 4KVA minimum Range: -13% to +6% of input	
GPIB Controller*	Full GPIB capabilities	HP Series 300 or Vectra with and GPIB card
¹ Required for Operation Verification Tests. *Required for remote testing of 667xA models.		

Electronic Load

Many of the test procedures require the use of a variable load capable of dissipating the required power. If a variable resistor is used, switches must be used for connecting, disconnecting, and shorting the load resistor. For most tests, an electronic load (see Table 2-1) is easier to use than a variable resistor. However, an electronic load may not be fast enough for testing transient recovery time or may be too noisy for testing noise (PARD). In these cases, fixed load resistors of suitable power dissipation can be used with minor changes to the test procedures given in this chapter.

Programming the Tests

General Considerations

Procedures are given for programming these tests either from the front panel keypad or from a GPIB controller for a GPIB controller for 667xA system supplies. The procedures assume you know how to use the front panel keypad or how to program over the GPIB (see the Power Supply Operating Manual for more information). When using computer-controlled tests, you may have to consider the relatively slow (compared to computer and system voltmeters) settling times and slew rates of the power supply. Suitable **WAIT** statements can be inserted into the test program to give the power supply time to respond to the test commands.

WARNING

Hazardous voltages may be present at the power supply output during these tests. They should be performed only by qualified electronics personnel.

Programming Parameters

Table 2-2 lists the programming voltage and current values for each model. You can enter these values either from the front panel or from a controller over the GPIB (for system power supplies).

Table 2-2. Programming Voltage and Current Values

Keysight Model	Full Scale Voltage	Max. Prog. Voltage	Full Scale Current	Max. Prog. Current	Max. Prog. Overvoltage	-CC Current
Keysight 6571A, 6671A	8V	8.190V	220A	225.23A	10V	10A
Keysight 6572A, 6672A	20V	20.475V	100A	102.37A	24V	10A
Keysight 6573A, 6673A	35V	35.831V	60A	61.43A	42V	5A
Keysight 6574A, 6674A	60V	61.425V	35A	35.83A	72V	4A
Keysight 6575A, 6675A	120V	122.85V	18A	18.43A	144V	2.5A

General Measurement Techniques

Figure 2-1 shows the setup for most tests. Measure the dc output voltage directly at the sense (+S and -S) terminals. Connect these terminals for *remote sensing* (to the +LS and -LS terminals). Be certain to use load leads of sufficient wire gauge to carry the output current (see Chapter 4 of the Power Supply Operating Manual). To avoid noise pickup, use coaxial cable or shielded pairs for the test leads. If you use more than one meter or a meter and an oscilloscope, connect separate leads for each instrument to avoid mutual-coupling effects.

Performance Test Record Sheets

When performing the tests in this chapter, refer to the Performance Test Record sheets supplied at the end of this chapter. Table 2-6 is for recording common information, such as, the test equipment used and the environmental conditions. Tables 2-7 through 2-11 are dedicated to specific models and contain the acceptable test values and ranges. A place is provided to record the results of the test.

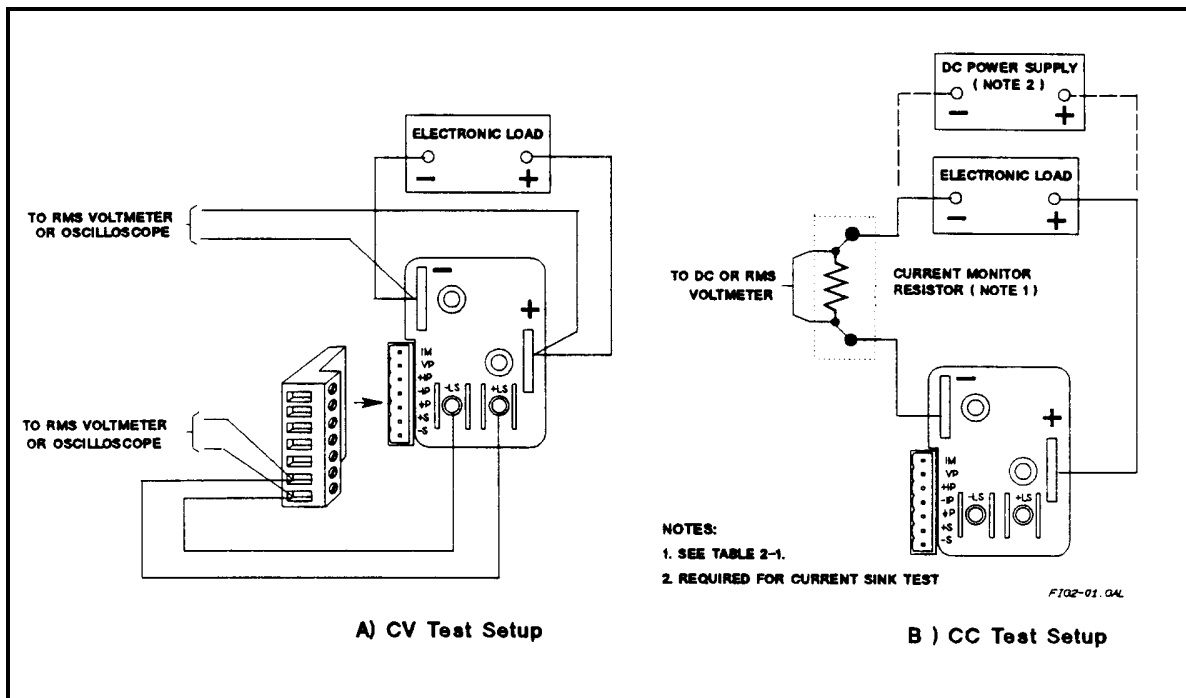

Figure 2-1. Constant Voltage (CV) Test Setup

Note It is recommended that before you perform the tests in either Table 2-4 or Table 2-5, that you first locate the appropriate Performance Test Record sheet from Tables 2-7 through Table 2-11 for your specific model. Make a copy of this sheet, and record the actual observed values in it while performing the tests. Use the sheets in Tables 2-7 through Table 2-11 as master reference sheets to run copies at any time.

Operation Verification Tests

Table 2-3 lists the requirements for operation verification, which is a subset of the performance tests.

Table 2-3. Operation Verification Tests

Test	Refer To
1 Turn-On Checkout	Power Supply Operating Manual
2 Voltage Programming and Readback Accuracy	Table 2-4
3 Current Programming and Readback Accuracy	Table 2-5

Record the results of Tests 2 and 3 in the appropriate Performance Test Record sheets.

Performance Tests

Performance tests check all the specifications of the power supply. The tests are grouped into constant-voltage mode tests (Table 2-4) and constant-current mode tests (Table 2-5).

Constant Voltage (CV) Tests

Test Setup

Connect your dc voltmeter leads to only +S and -S (see Figure 2-1), because the power supply regulates the voltage between these points, not between the + and - output terminals .

Test Procedures

Perform the test procedures in Table 2-4. The CV tests are:

- Voltage Programming and Readback Accuracy.
- CV Load Effect.
- CV Source Effect.
- CV Noise (PARD).
- Transient Recovery Time.

Note The tests are independent and may be performed in any order.

Table 2-4. Constant Voltage (CV) Tests

	Action	Normal Result
Voltage Programming and Readback Accuracy		
<p>This test verifies that the voltage programming, GPIB readback (GPIB system power supplies only), and front panel display functions are within specifications. With system power supplies, values read back over the GPIB should be the same as those displayed on the front panel.</p>		
1	Turn off the power supply and connect a DVM across +LS and -LS (see Figure 2-1A).	
2	Turn on the power supply with no load and program the output for 0 volts and maximum programmable current (see Table 2-2).	CV annunciator on. Output current near 0.
3	Record voltage readings at DVM and on front panel display.	Readings within specified Low Voltage limits.
4	Program voltage to full scale (see Table 2-2).	
5	Record voltage readings of DVM and on front panel display.	Readings within specified High Voltage limits.
CV Load Effect		
<p>This test measures the change in output voltage resulting from a change in output current from full-load to no-load.</p>		
1	Turn off the power supply and connect a DVM across +LS and -LS (see Figure 2-1A).	
2	Turn on the power supply and program the current to its maximum programmable value and the voltage to its full-scale value (see Table 2-2).	
3	Adjust the load to produce full-scale current (see Table 2-2) as shown on the front panel display.	CV annunciator is on. If it is not, adjust the load to slightly reduce the output current until the annunciator comes on.
4	Record voltage reading of the DVM.	
5	Adjust load to draw 0 amperes (open load). Record voltage reading of the DVM.	
6	Check test result.	The difference between the DVM readings in steps 4 and 5 are within the specified Load Effect limits.
CV Source Effect		
<p>This test measures the change in output voltage resulting from a change in ac line voltage from its minimum to maximum value within the line voltage specifications.</p>		
1	Turn off the power supply and connect the ac power input through a variable-voltage transformer.	

Table 2-4. Constant Voltage (CV) Tests (continued)

	Action	Normal Result
CV Source Effect (cont)		
2	Set the transformer to the nominal ac line voltage. Connect the DVM across +LS and -LS (see Figure 2-1A).	
3	Turn on the power supply and program the current to its maximum programmable value and the voltage to its full-scale value (see Table 2-2).	
4	Adjust the load to produce full-scale current (see Table 2-2) as shown on the front panel display.	CV annunciator is on. If it is not, adjust the load to slightly reduce the output current until the annunciator comes on.
5	Adjust the transformer to decrease the ac input voltage to the low-line condition (174Vac or 191Vac). Record the output voltage reading of the DVM.	
6	Adjust the transformer to increase the ac input voltage to the high-line condition (220Vac or 250Vac). Record the output voltage reading on the DVM.	
7	Check test result.	The difference between the DVM readings in steps 5 and 6 are within the specified Source Effect limits.
CV Noise (PARD)		
Periodic and random deviations (PARD) in the output (ripple and noise) combine to produce a residual ac voltage superimposed on the dc output voltage. This test measures CV PARD, specified as the rms and peak-to-peak output voltages over the frequency range of 20Hz to 20MHz.		
1	Turn off the power supply and connect an a-c coupled oscilloscope across the + and -output terminals (see Figure 2-1A). Set the oscilloscope bandwidth limit to 20MHz (30MHz for the Keysight 54504A) and use an RF tip on the oscilloscope probe.	
2	Turn on the power supply and program the current to its maximum programmable value and the voltage to its full-scale value (see Table 2-2).	
3	Adjust the load to produce full-scale current (see Table 2-2) as shown on the front panel display.	CV annunciator is on. If it is not, adjust the load to slightly reduce the output current until the annunciator comes on.
4	Record the amplitude of the waveform.	Amplitude is within the specified PARD Peak-to-Peak limits.
5	Replace the oscilloscope connection with an ac rms voltmeter.	
6	Record the reading obtained in Step 5.	Amplitude is within the specified PARD rms limits.

Table 2-4. Constant Voltage (CV) Tests (continued)

	Action	Normal Result
Transient Recovery Time		
<p>This test measures the time required for the output voltage to return to within 0.1% or 100mV, whichever is greater, of its final value following a 50% change in output load current. Measurements are made on both the unloading transient (from full load to 1/2 load) and the loading transient (from 1/2 load to full load).</p>		
1	Turn off the power supply and connect an oscilloscope across +LS and -LS (see Figure 2-1A).	
2	Turn on the power supply and program the current to its maximum programmable value and the voltage to its full-scale value (see Table 2-2).	
3	Program the Electronic Load as follows: <ul style="list-style-type: none"> ⌋ Operating mode to constant current. ⌋ Input load current to 1/2 the supply's full rated output current. ⌋ Transient current level to the supply's full rated output current. ⌋ Transient generator frequency = 100Hz. ⌋ Transient generator duty cycle = 50%. 	
4	Turn on the transient and adjust the oscilloscope to display response waveform.	See Figure 2-2.
5	Measure both the loading and unloading transients by triggering the oscilloscope on both the negative and positive slopes of the transient. Record the voltage level obtained at the 900-μs interval .	Specified voltage level is reached within 900μs.

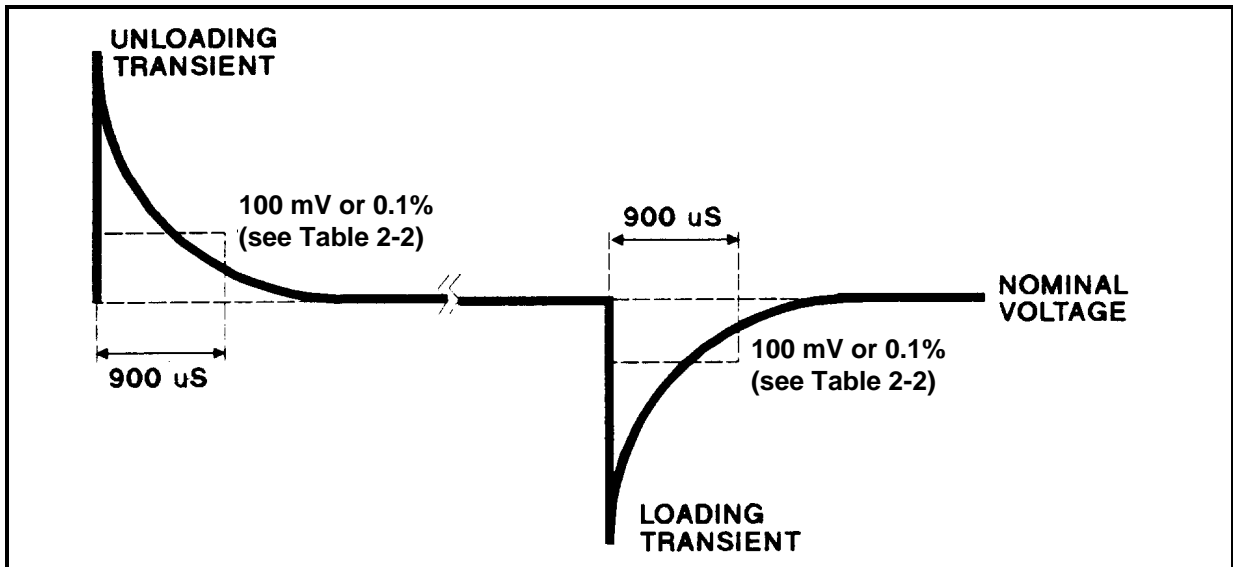

Figure 2-2. Transient Response Waveform

Constant Current (CC) Tests

Test Setup

Connect the appropriate current monitoring resistor (see Table 2-1) as shown in Figure 2-1B. The accuracy of the resistor must be as specified in the table.

Test Procedures

The test procedures are given in Table 2-5. The tests are independent and may be performed in any order. The CC tests are:

- Current Programming and Readback Accuracy.
- Current Sink (-CC) Operation.
- CC Load Effect.
- CC Source Effect.
- CC Noise (PARD).

Table 2-5. Constant Current (CC) Tests

	Action	Normal Result
Current Programming and Readback Accuracy		
This test verifies that the current programming and readback are within specification.		
1	Turn off the power supply and connect the current monitoring resistor as shown in Figure 2-1B. Connect a DVM across the resistor.	
2	Turn on the power supply and program the output for 5 volts and 0 amperes.	
3	Short the load.	
4	Observe the DVM voltage reading. Divide this by the resistance of the current monitor resistor. Record the result as the Low Current value.	Value within specified Low Current limits.
5	Record the front panel display readback.	Value within specified readback limits.
6	Program output current to full scale (see Table 2-2).	
7	Repeat Steps 4 and 5.	Both current readings within specified High Current and readback limits.
Current Sink (CC-) and Readback Accuracy		
This test verifies current sink operation and readback accuracy.		
1	Turn off the power supply. Connect the output as shown in Figure 2-1B, except replace the Electronic Load with the external test supply specified in Table 2-1.	
2	Set the external supply to 5 volts and its current limit to the -CC value of the power supply under test (see Table 2-2).	
3	Turn on the power supply under test and program its output voltage to 0.	

Table 2-5. Constant Current (CC) Tests (continued)

	Action	Normal Result
Current Sink (CC-) and Readback Accuracy (cont)		
4	Observe the DVM voltage reading. Divide this by the resistance of the current monitor resistor to obtain the current sink value.	Value within Current Sink Display Readback limits.
5	Subtract the current value obtained in Step 4 from the current reading on the power supply display. Record the difference as the Current Sink Display Readback.	
CC Noise (PARD)		
<p>Periodic and random deviations (PARD) in the output (ripple and noise) combine to produce a residual ac current superimposed on the dc output current. This test measures CC PARD, specified as the rms output current over the frequency range of 20 Hz to 20 MHz.</p>		
1	Turn off the power supply and connect the current monitoring resistor and rms voltmeter (see Figure 2-1). Make the test leads as short as possible to reduce noise pickup.	<p>The power supply output current should be at its full-scale value and the CC annunciator on. If it is not, adjust the load to slightly reduce the output voltage until the annunciator comes on.</p> <p>Current is within the specified PARD rms limits.</p>
2	Measure the residual noise on the RMS voltmeter with the power supply turned off. Noise generated by other equipment may affect this measurement and should be removed or factored out.	
3	Turn on the power supply and program the current to its full scale value and the voltage to its maximum programmable value (see Table 2-2).	
4	Adjust the load in the CV mode for full-scale voltage (see Table 2-2) as shown on the front panel display.	
5	Observe the reading on the rms voltmeter. Divide this voltage by the resistance of the current monitoring resistor to obtain the rms noise current.	
CC Load Effect		
<p>This test measures the change in output current resulting from a change in load from full-load voltage to a short circuit. It is recommended that you use averaged readings for Steps 4 and 5 of this test (see Averaging AC Measurements at the end of this chapter).</p>		
1	Turn off the power supply and connect a DVM across the current monitoring resistor (see Figure 2-1).	<p>Power supply output current is full scale and its CC annunciator is on. If not, reduce the Electronic Load voltage slightly until the annunciator comes on.</p>
2	Turn on the power supply and program the current to its full scale value and the voltage to its maximum programmable value (see Table 2-2).	
3	Set the Electronic Load to CV mode and its voltage to full scale as indicated on its front panel display.	

Table 2-5. Constant Current (CC) Tests (continued)





	Action	Normal Result
CC Load Effect (cont)		
4	Observe the DVM reading. Divide this by the resistance of the current monitoring resistor to obtain the output current. Record the result.	You may want to use an averaged reading for this measurement.
5	Short the Electronic Load input and repeat Step 4.	You may want to use averaged reading for this measurement.
6	Check the result.	The difference between the current readings taken in Step 4 and Step 5 must be within specified "Load Effect" limits.
CC Source Effect		
<p>This test measures the change in output current resulting from a change in ac line voltage from its minimum to its maximum value within the line voltage specifications. It is recommended that you use averaged readings for Steps 6 and 8 of this test (see "Averaging AC Measurements" at the end of this chapter).</p>		
1	Turn off the power supply and connect the ac power input through a variable-voltage transformer.	
2	Set the transformer to the nominal ac line voltage. Connect the DVM across the current monitoring resistor (see Figure 2-1).	
3	Turn on the power supply and program the current to its full-scale value and the voltage to its maximum programmable value (see Table 2-2).	
4	Set the Electronic Load to CV mode and its voltage to full scale.	The power supply output current is full scale and its CC annunciator is on. If not, reduce the Electronic Load voltage slightly until the annunciator comes on.
5	Adjust the transformer to decrease the ac input voltage to the low-line condition (174Vac or 191Vac).	
6	Observe the DVM reading. Divide this voltage by the resistance of the current monitoring resistor to obtain the output current. Record the result.	You may want to use an averaged reading for this measurement.
7	Adjust the transformer to increase the ac input voltage to the high-line condition (220Vac or 250Vac).	
8	Observe the DVM reading. Divide this voltage by the resistance of the current monitoring resistor to obtain the output current. Record the result.	You may want to use an averaged reading for this measurement.
9	Check the test result.	The difference between the current readings found in Step 6 and Step 8 is within the specified current Source Effect limits.

Averaging the CC Measurements

The CC Load Effect and CC Source Effect tests measure the dc regulation of the power supply's output current. When doing these tests, you must be sure that the readings taken are truly dc regulation values and not instantaneous ac peaks of the output current ripple. You can do this by making each measurement several times and then using the average of the measurements as your test value. Voltmeters such as the Keysight 3458A System Voltmeter can be programmed to take just such statistical average readings as required by these tests.

The following steps show how to set up the voltmeter from its front panel to take a statistical average of 100 readings.

 represents the unlabeled shift key in the FUNCTION/RANGE group.

1. Program 10 power line cycles per sample by pressing **NPLC** **1** **0** **Enter**.
2. Program 100 samples per trigger by pressing **N Rds/Trig** **1** **0** **0** **Enter**.
3. Set up voltmeter to take measurements in the statistical mode as follows:
 - a. Press  **f0**  **N**.
 - b. Press **▲** until MATH function is selected, then press **▶**.
 - c. Press **▲** until STAT function is selected, then press **Enter**.
4. Now set up voltmeter to read the average of the measurements as follows:
 - a. Press  **f1**  **N**.
 - b. Press **▼** until RMATH function is selected, then press **Enter**.
 - c. Press **▲** until MEAN function is selected, then press **Enter**.
5. Execute the average reading program by pressing **f0** **Enter** **TRIG** **Enter**.
6. Wait for 100 readings and then read the average measurement by pressing **f1** **Enter**.

Record this as your result.

Table 2-6. Performance Test Record Form

Test Facility:

_____	Report No. _____
_____	Date _____
_____	Customer _____
_____	Tested By _____
Model _____	Ambient Temperature (°C) _____
Serial No. _____	Relative Humidity (%) _____
Options _____	Nominal Line Frequency (Hz) _____
Firmware Revision _____	

Special Notes:

Test Equipment Used:

Description	Model No.	Trace No.	Cal. Due Date
1. AC Source	_____	_____	_____
2. DC Voltmeter	_____	_____	_____
3. RMS Voltmeter	_____	_____	_____
4. Oscilloscope	_____	_____	_____
5. Electronic Load	_____	_____	_____
6. Current Monitoring Shunt	_____	_____	_____

Table 2-7. Performance Test Record for Keysight Model 6571A or 6671A

MODEL Keysight _____	Report No. _____		Date _____	
Test Description	Minimum Spec.	Results *	Maximum Spec.	
Constant Voltage Tests				
Voltage Programming and Readback				
Low Voltage (0V) V_{out} Front Panel Display Readback	-8mV $V_{out} - 12mV$	_____mV _____mV	+8mV $V_{out} + 12mV$	
High Voltage (8V) V_{out} Front Panel Display Readback	7.9888V $V_{out} - 16mV$	_____V _____mV	8.0112V $V_{out} + 16mV$	
Load Effect	$V_{out} - 0.46mV$	_____mV	$V_{out} + 0.46mV$	
Source Effect	$V_{out} - 0.46mV$	_____mV	$V_{out} + 0.46mV$	
PARD (Ripple and Noise)				
Peak-to-Peak	0	_____mV	7mV	
RMS	0	_____μV	650μV	
Transient Response Time (at 900 μs)	0	_____mV	100mV	
Constant Current Tests				
Current Programming and Readback				
Low Current (0A) I_{out} Front Panel Display Readback	-125mA $I_{out} - 150mA$	_____mA _____mA	+125mA $I_{out} + 150mA$	
High Current (220A) I_{out} Front Panel Display Readback	219.655A $I_{out} - 370mA$	_____A _____mA	+220.345A $I_{out} + 370mA$	
Current Sink (10A) Display Readback	$I_{sink} - 160mA$	_____mA	$I_{sink} + 160mA$	
PARD (Ripple and Noise) RMS	0	_____mA	200mA	
Load Effect	$I_{out} - 21mA$	_____mA	$I_{out} + 21mA$	
Source Effect	$I_{out} - 21mA$	_____mA	$I_{out} + 21mA$	
*Enter your test results in this column.				

Table 2-8. Performance Test Record for Keysight Model 6572A or 6672A

MODEL Keysight _____	Report No. _____		Date _____	
Test Description	Minimum Spec.	Results *	Maximum Spec.	
Constant Voltage Tests				
Voltage Programming and Readback				
Low Voltage (0V) V_{out} Front Panel Display Readback	-20mV $V_{out} - 30mV$	_____mV _____mV	+20mV $V_{out} + 30mV$	
High Voltage (20V) V_{out} Front Panel Display Readback	19.972V $V_{out} - 40mV$	_____V _____mV	20.028V $V_{out} + 40mV$	
Load Effect	$V_{out} - 1.05mV$	_____mV	$V_{out} + 1.05mV$	
Source Effect	$V_{out} - 1.05mV$	_____mV	$V_{out} + 1.05mV$	
PARD (Ripple and Noise)				
Peak-to-Peak	0	_____mV	9mV	
RMS	0	_____μV	750μV	
Transient Response Time (at 900 μs)	0	_____mV	100mV	
Constant Current Tests				
Current Programming and Readback				
Low Current (0A) I_{out} Front Panel Display Readback	-60mA $I_{out} - 100mA$	_____mA _____mA	+60mA $I_{out} + 100mA$	
High Current (100A) I_{out} Front Panel Display Readback	99.84A $I_{out} - 200mA$	_____A _____mA	+100.16A $I_{out} + 200mA$	
Current Sink (10A) Display Readback	$I_{sink} - 110mA$	_____mA	$I_{sink} + 110mA$	
PARD (Ripple and Noise) RMS	0	_____mA	100mA	
Load Effect	$I_{out} - 12mA$	_____mA	$I_{out} + 12mA$	
Source Effect	$I_{out} - 12mA$	_____mA	$I_{out} + 12mA$	
*Enter your test results in this column.				

Table 2-9. Performance Test Record for Keysight Model 6573A or 6673A

MODEL Keysight _____	Report No. _____		Date _____	
Test Description	Minimum Spec.	Results *	Maximum Spec.	
Constant Voltage Tests				
Voltage Programming and Readback				
Low Voltage (0V) V_{out} Front Panel Display Readback	-35mV $V_{out} - 50mV$	_____mV _____mV	+35mV $V_{out} + 50mV$	
High Voltage (35V) V_{out} Front Panel Display Readback	34.951V $V_{out} - 67.5mV$	_____V _____mV	35.049V $V_{out} + 67.5mV$	
Load Effect	$V_{out} - 1.9mV$	_____mV	$V_{out} + 1.9mV$	
Source Effect	$V_{out} - 1.9mV$	_____mV	$V_{out} + 1.9mV$	
PARD (Ripple and Noise)				
Peak-to-Peak	0	_____mV	9mV	
RMS	0	_____μV	800μV	
Transient Response Time (at 900 μs)	0	_____mV	100mV	
Constant Current Tests				
Current Programming and Readback				
Low Current (0A) I_{out} Front Panel Display Readback	-40mA $I_{out} - 60mA$	_____mA _____mA	+40mA $I_{out} + 60mA$	
High Current (60A) I_{out} Front Panel Display Readback	59.9A $I_{out} - 120mA$	_____A _____mA	+60.1A $I_{out} + 120mA$	
Current Sink (5A) Display Readback	$I_{sink} - 65mA$	_____mA	$I_{sink} + 65mA$	
PARD (Ripple and Noise) RMS	0	_____mA	40mA	
Load Effect	$I_{out} - 7mA$	_____mA	$I_{out} + 7mA$	
Source Effect	$I_{out} - 7mA$	_____mA	$I_{out} + 7mA$	
*Enter your test results in this column.				

Table 2-10. Performance Test Record for Keysight Model 6574A or 6674A

MODEL Keysight _____	Report No. _____		Date _____	
Test Description	Minimum Spec.	Results *	Maximum Spec.	
Constant Voltage Tests				
Voltage Programming and Readback				
Low Voltage (0V) V_{out} Front Panel Display Readback	-60mV $V_{out} - 90mV$	_____mV _____mV	+60mV $V_{out} + 90mV$	
High Voltage (60V) V_{out} Front Panel Display Readback	59.916V $V_{out} - 120mV$	_____V _____mV	60.084V $V_{out} + 120mV$	
Load Effect	$V_{out} - 3.2mV$	_____mV	$V_{out} + 3.2mV$	
Source Effect	$V_{out} - 3.2mV$	_____mV	$V_{out} + 3.2mV$	
PARD (Ripple and Noise)				
Peak-to-Peak	0	_____mV	11mV	
RMS	0	_____mV	1.25mV	
Transient Response Time (at 900 μs)	0	_____mV	100mV	
Constant Current Tests				
Current Programming and Readback				
Low Current (0A) I_{out} Front Panel Display Readback	-25mA $I_{out} - 35mA$	_____mA _____mA	+25mA $I_{out} + 35mA$	
High Current (35A) I_{out} Front Panel Display Readback	34.94A $I_{out} - 70mA$	_____A _____mA	+35.06A $I_{out} + 70mA$	
Current Sink (4A) Display Readback	$I_{sink} - 39mA$	_____mA	$I_{sink} + 39mA$	
PARD (Ripple and Noise) RMS	0	_____mA	25mA	
Load Effect	$I_{out} - 3.75mA$	_____mA	$I_{out} + 3.75mA$	
Source Effect	$I_{out} - 3.75mA$	_____mA	$I_{out} + 3.75mA$	
*Enter your test results in this column.				

Table 2-11. Performance Test Record for Keysight Model 6575A or 6675A

MODEL Keysight _____	Report No. _____		Date _____	
Test Description	Minimum Spec.	Results *	Maximum Spec.	
Constant Voltage Tests				
Voltage Programming and Readback				
Low Voltage (0V) V_{out} Front Panel Display Readback	-120mV $V_{out} - 180mV$	_____mV _____mV	+120mV $V_{out} + 180mV$	
High Voltage (120V) V_{out} Front Panel Display Readback	119.832V $V_{out} - 240mV$	_____V _____mV	120.168V $V_{out} + 240mV$	
Load Effect	$V_{out} - 6.4mV$	_____mV	$V_{out} + 6.4mV$	
Source Effect	$V_{out} - 6.4mV$	_____mV	$V_{out} + 6.4mV$	
PARD (Ripple and Noise)				
Peak-to-Peak	0	_____mV	16mV	
RMS	0	_____mV	1.9mV	
Transient Response Time (at 900 μs)	0	_____mV	120mV	
Constant Current Tests				
Current Programming and Readback				
Low Current (0A) I_{out} Front Panel Display Readback	-12mA $I_{out} - 18mA$	_____mA _____mA	+12mA $I_{out} + 18mA$	
High Current (18A) I_{out} Front Panel Display Readback	17.97A $I_{out} - 36mA$	_____A _____mA	+18.03A $I_{out} + 36mA$	
Current Sink (2.5A) Display Readback	$I_{sink} - 20.5mA$	_____mA	$I_{sink} + 20.5mA$	
PARD (Ripple and Noise) RMS	0	_____mA	12mA	
Load Effect	$I_{out} - 1.9mA$	_____mA	$I_{out} + 1.9mA$	
Source Effect	$I_{out} - 1.9mA$	_____mA	$I_{out} + 1.9mA$	
*Enter your test results in this column.				

Troubleshooting

WARNING

Shock Hazard: Most of the procedures in this chapter must be performed with power applied and protective covers removed. These procedures should be done only by trained service personnel aware of the hazard from electrical shock.

CAUTION

This instrument uses components that can be damaged or suffer serious performance degradation due to ESD (electrostatic discharge). Observe standard antistatic precautions to avoid damage to the components (see Chapter 1).

Introduction

Localizing the Problem

This chapter provides troubleshooting and repair information for the power supply. Before beginning troubleshooting procedures, make certain the problem is in the power supply and not with an associated circuit, the GPIB controller (for system power supplies), or ac input line. Without removing the covers, you can use the Verification tests in Chapter 2 to determine if the power supply is operating normally.

Chapter Organization

The information in this chapter is organized as follows:

Topic	Information Given
Test Equipment Required	Equipment required for completing all the tests in this chapter.
Troubleshooting Procedures	<p>A series of flow charts for systematic location of defective boards, circuits, and components.</p> <p>An explanation of the error codes and messages generated during the power-on selftest.</p> <p>Signature analysis techniques for troubleshooting the digital circuits on the front panel, primary, and secondary interface circuits .</p> <p>Specific paragraphs for:</p> <ul style="list-style-type: none"> • Checking the bias and reference supplies. • Troubleshooting the CV/CC status annunciators. • Troubleshooting the A3 FET board.
Post-Repair Adjustments	Calibration and EEPROM initialization procedures required after the replacement of certain critical components.
Disassembly Procedures	Gaining access to and/or replacing components.

Test Equipment Required

Table 3-1. Test Equipment Required

Equipment	Purpose	Recommended Model
Logic Probe Test Clips Ammeter/Current Shunt	To check states of data lines. To gain access to IC pins. To measure output current.	Keysight 545A AP Products No. LTC Keysight 6571A & 6671A: Guildline 9230/300 Keysight 6572A-75A & 6672A-75A: Guildline 9230/100
Oscilloscope Signature Analyzer	To check waveforms and signal levels. To troubleshoot most of the primary and secondary interface circuits.	Keysight 54504A Keysight 5005A/B
GPIB Controller	To communicate with power supply via the GPIB (for system units).	Keysight BASIC Series
DC Voltmeter	To measure output voltage and current, bias and references.	Keysight 3458A

Troubleshooting Procedures

Power-On Selftest

Description

The procedures in the troubleshooting charts make use of the power-on selftest. The power-on selftest tests the front panel, GPIB interface (for GPIB system power supplies) or Isolator Board (bench supplies), and secondary interface circuits. If the power supply fails the selftest, the output remains disabled (turned off) and the front panel normally displays an error code or message (see Table 3-2). The message is displayed indefinitely and the power supply will not accept GPIB or front panel commands.

Disabling The Power-On Selftest

In order to perform troubleshooting procedures that require programming of the power supply, you must disable the power-on selftest. Do this as follows:

1. Turn off the power supply.
2. Hold down the **7** key and turn on the supply.
3. Continue holding down the **7** for 2 seconds and wait until the **PWR ON INIT** indicator goes off.
4. The power supply is now on without executing power-on selftest.

Using the *TST? Query (GPIB Systems Supplies Only)

You can get the power supply to execute a partial selftest by sending it the GPIB ***TST?** query command. Table 3-2 shows the tests that are performed in response to this command. These tests do not interfere with normal operation or cause the output to change. The command returns a value of "0" if all tests pass. Otherwise, the command returns the error code of the first test that failed. No error codes are displayed on the front panel and the power supply will attempt to continue normal operation.

Table 3-2. Selftest Error Codes/Messages

Code and/or Message	Description	Probable Cause Selftest Error Codes/Messages
E1 FP RAM	Front panel RAM test failed (power-on)	Microprocessor A1U3
E2 FP ROM	Front panel ROM test failed (power-on and *TST?)	ROM A1U4 or address latches A1U8
E3 EE CHKSM	Front panel EEPROM checksum test failed (power-on and *TST?)	Possibly due to power loss during a write operation. See Checksum Errors in Chapter 3 of Operating Manual. If power loss is not the problem, EEPROM A1U6 could be defective. (If you replace A1U6, the power supply must be reinitialized and calibrated.)
E4 PRI XRAM** ¹	Primary interface external RAM test failed (power-on)	RAM A2U108
E5 PRI IRAM**	Primary interface internal RAM test failed (power-on)	Microprocessor A2U114
E6 PRI ROM**	Primary interface ROM test failed (power-on and *TST?)	ROM A2U106
E7 GPIB **	GPIB interface test failed (power-on)	Talker/listener A2U117
E8 SEC RAM	Secondary interface RAM test failed (power-on)	Microprocessor A5U504
E9 SEC ROM	Secondary interface ROM test failed (power-on and *TST?)	Microprocessor A5U504
E10 SEC 5V	Secondary interface 5 volt readback test failed (power-on and *TST?)	Comparators A5U513, readback DAC A5U511/U512, or secondary bias supply (5Vs A4U304)
E11 TEMP	Ambient temperature readback test failed (power-on and *TST?)	Thermistor A5RT770 or comparator A5U513
E12 DACS	CV or CC DAC tests failed (power-on)	CV DAC A5U507/U508 or CC DAC A5U509/U510 (see Figure 3-7)
NOTE: The following error messages can appear due to a failure occurring either while the power supply is operating or during selftest.		
SERIAL TIMOUT	Serial data line failure on A2 board	See Figure 3-10 (system) or Figure 3-11 (bench).
SERIAL DOWN	Serial data line failure on A2 board	See Figure 3-10 (system) or Figure 3-11 (bench).
UART PARITY**	UART failed	UART A2U112
UART FRAMING**	UART failed	UART A2U112
UART OVERRUN**	UART failed	UART A2U112
SBUF OVERRUN**	Serial buffer failure UART	UART A2U112 defective or GPIB board is in SA mode
SBUF FULL**	Serial buffer failure	UART A2U112 defective or GPIB board is in SA mode
EE WRITE ERR	EEPROM write failure	EEPROM A1U6 defective or calibration error
SECONDARY DN	Serial data line failure on Main board	See Figure 3-12.

¹ A double asterisk indicates that the item applies only to 667xA system supplies.

Troubleshooting Charts

Figure 3-1 gives overall troubleshooting procedures to isolate the fault to a circuit board or particular circuit (see Figure 3-20 for the location of the circuit boards). These procedures include the use of power-on selftest (Table 3-2) and signature analysis techniques (Table 3-5 through Table 3-7). Some results of Figure 3-1 lead to more detailed troubleshooting charts that guide you to specific components. The troubleshooting charts are organized as follows:

Chart	Trouble or Circuit
Figure 3-1	Overall procedure checks selftest errors, calibration errors, ac input circuit, fan, readback circuits, A5 Control Board, GPIB cable, digital port, serial link, rotary controls, current amplifier.
Figure 3-2	No display (from Figure 3-1).
Figure 3-3	OV circuit not firing (from Figure 3-1).
Figure 3-4	OV circuit is on at turn-on (from Figure 3-1).
Figure 3-5	Output level is held low (from Figure 3-1).
Figure 3-6	Output level is held high (from Figure 3-1).
Figure 3-7	DAC circuits (from Figure 3-1).
Figure 3-8	DAC test waveforms.
Figure 3-9	CV and CC DAC and amplifiers (from Figure 3-1).
Figure 3-10	Serial interface circuit (from Figure 3-1).
Figure 3-11	Isolator board circuits.
Figure 3-12	Secondary interface down (from Figure 3-1).
Figure 3-13	Slow downprogramming circuit (from Figure 3-1).

Troubleshooting Test Points

The troubleshooting charts reference test points listed in Table 6-3 of Chapter 6. Test points are identified by an encircled number (such as $\textcircled{1}$ in schematic diagrams and component location drawings, also in Chapter 6).

Bias and Reference Supplies

Many of the following troubleshooting procedures begin by checking the bias and/or reference voltages. Table 6-3 lists the test points for these voltages and gives the correct reading for each. The circuit board component location diagrams identify these points on each board.

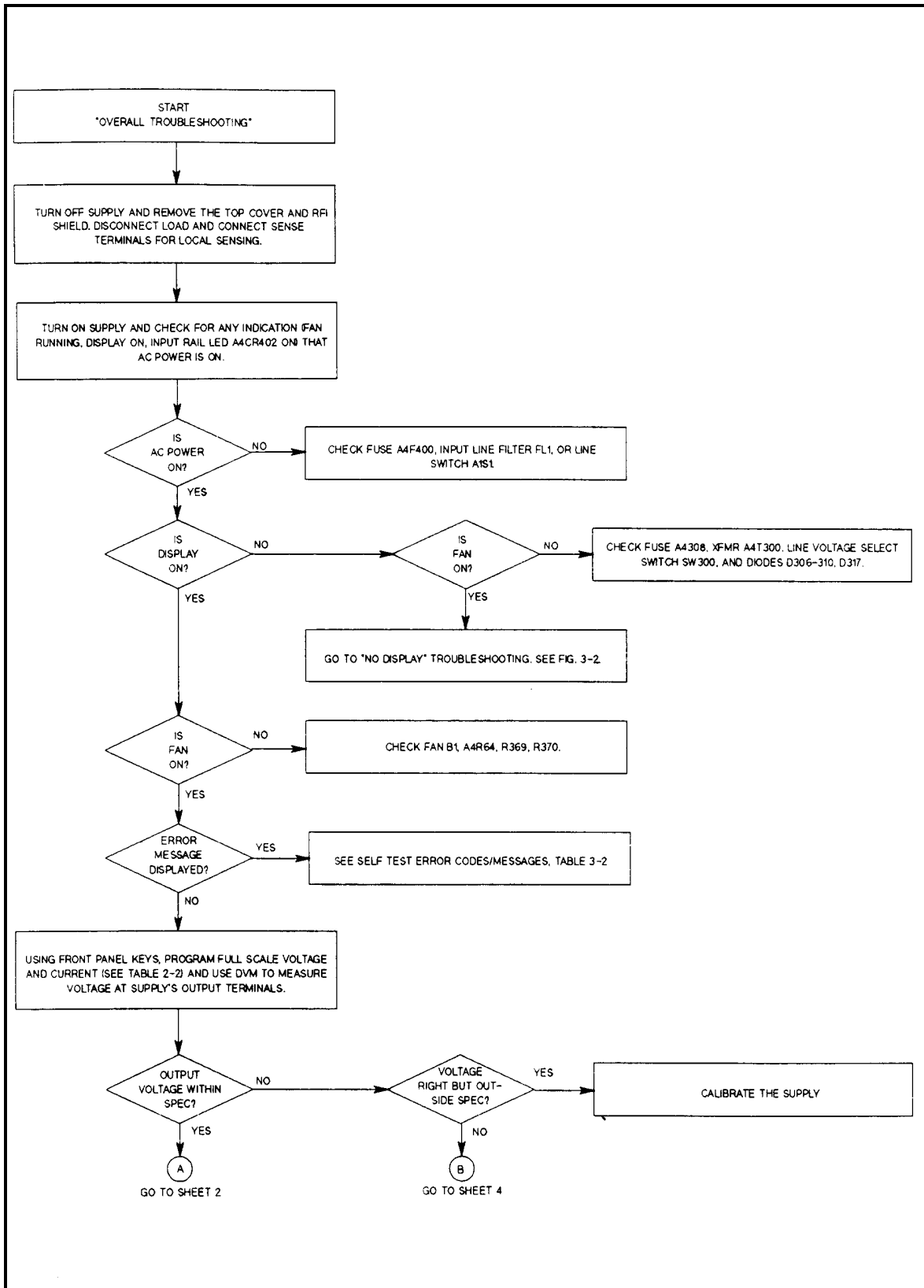

Figure 3-1. Overall Troubleshooting (Sheet 1 of 4)

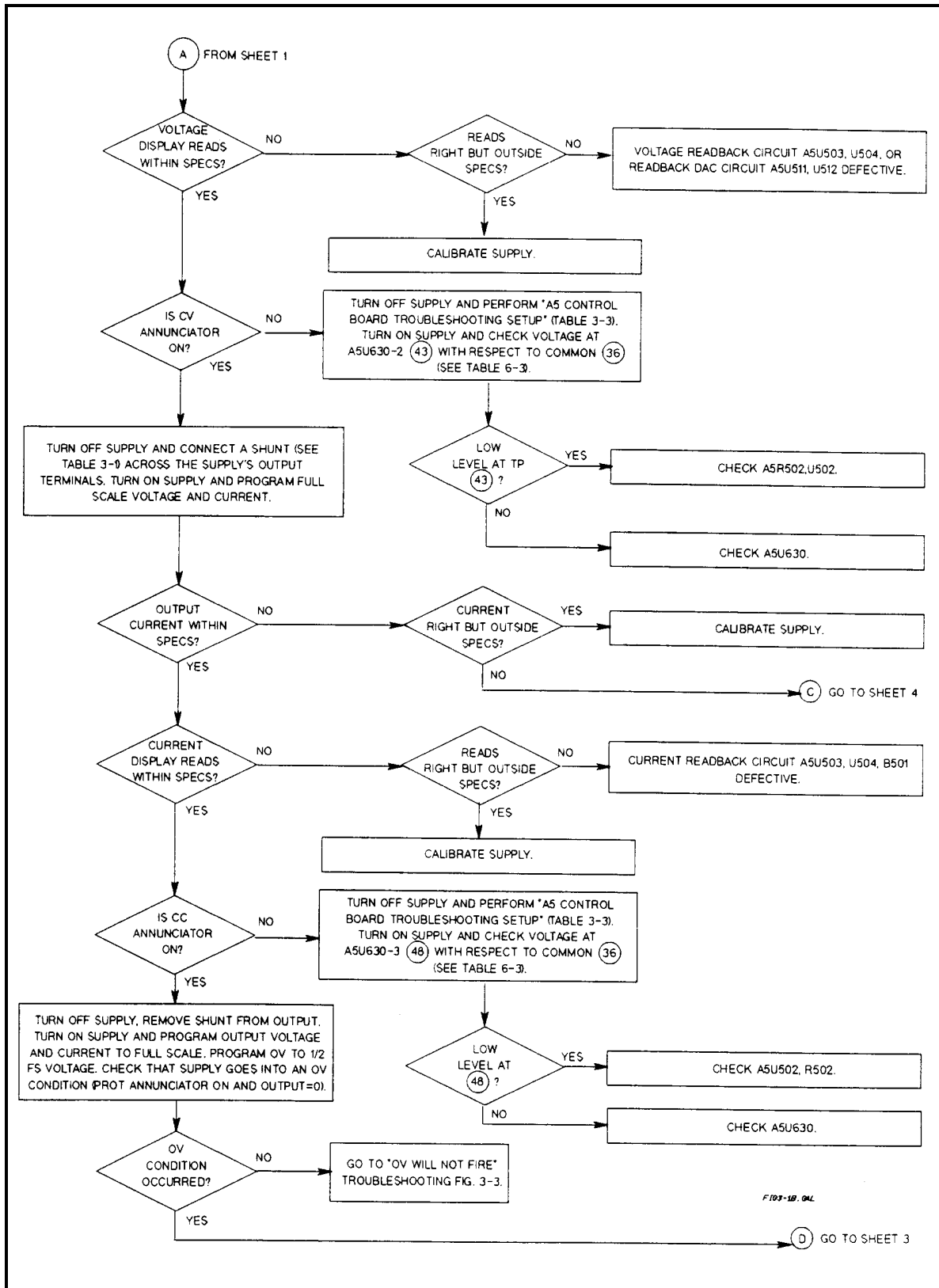

Figure 3-1. Overall Troubleshooting (Sheet 2 of 4)

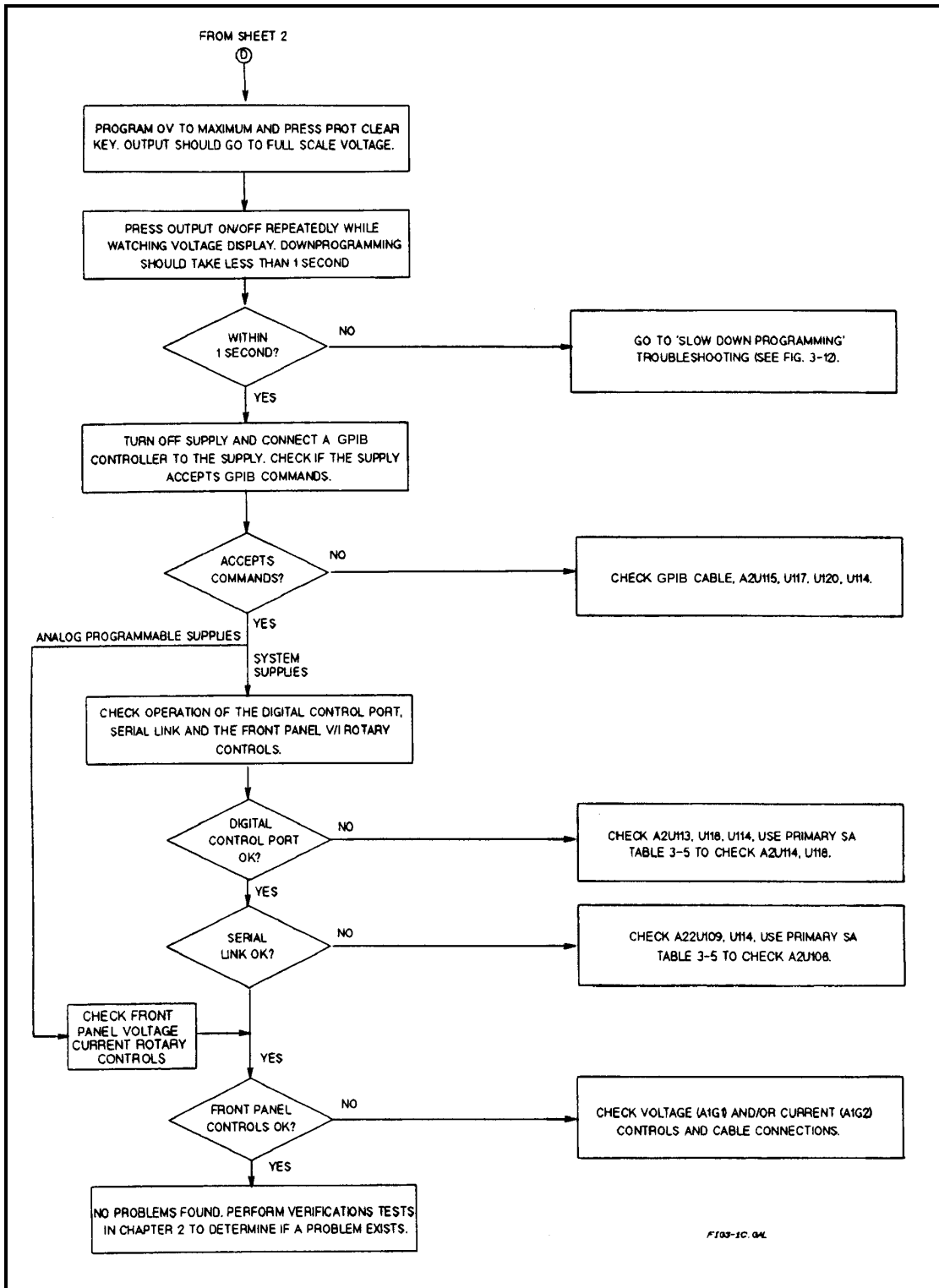

Figure 3-1. Overall Troubleshooting (Sheet 3 of 4)

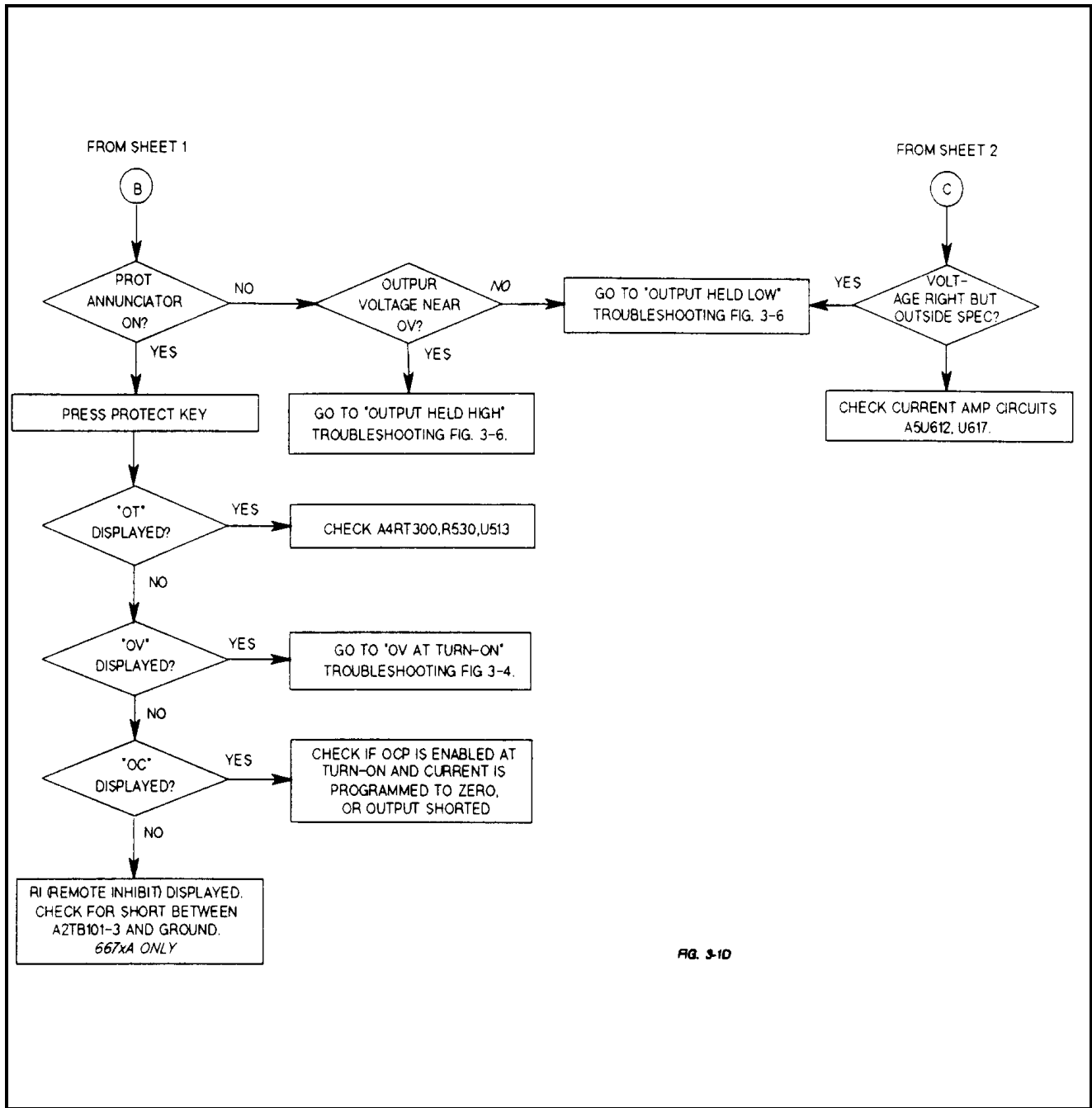

FIG. 3-1D

Figure 3-1. Overall Troubleshooting (Sheet 4 of 4)

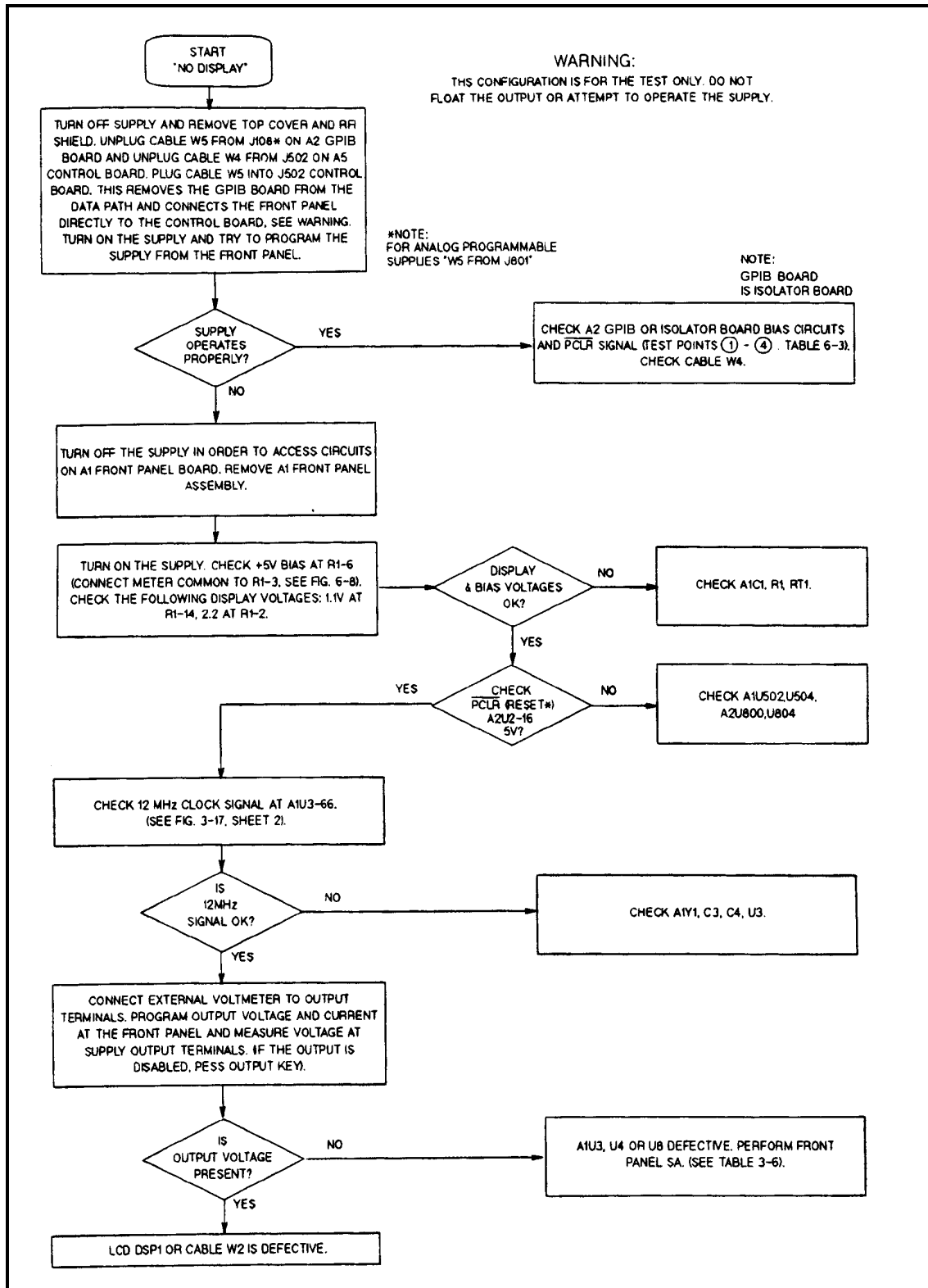

Figure 3-2. No Display Troubleshooting

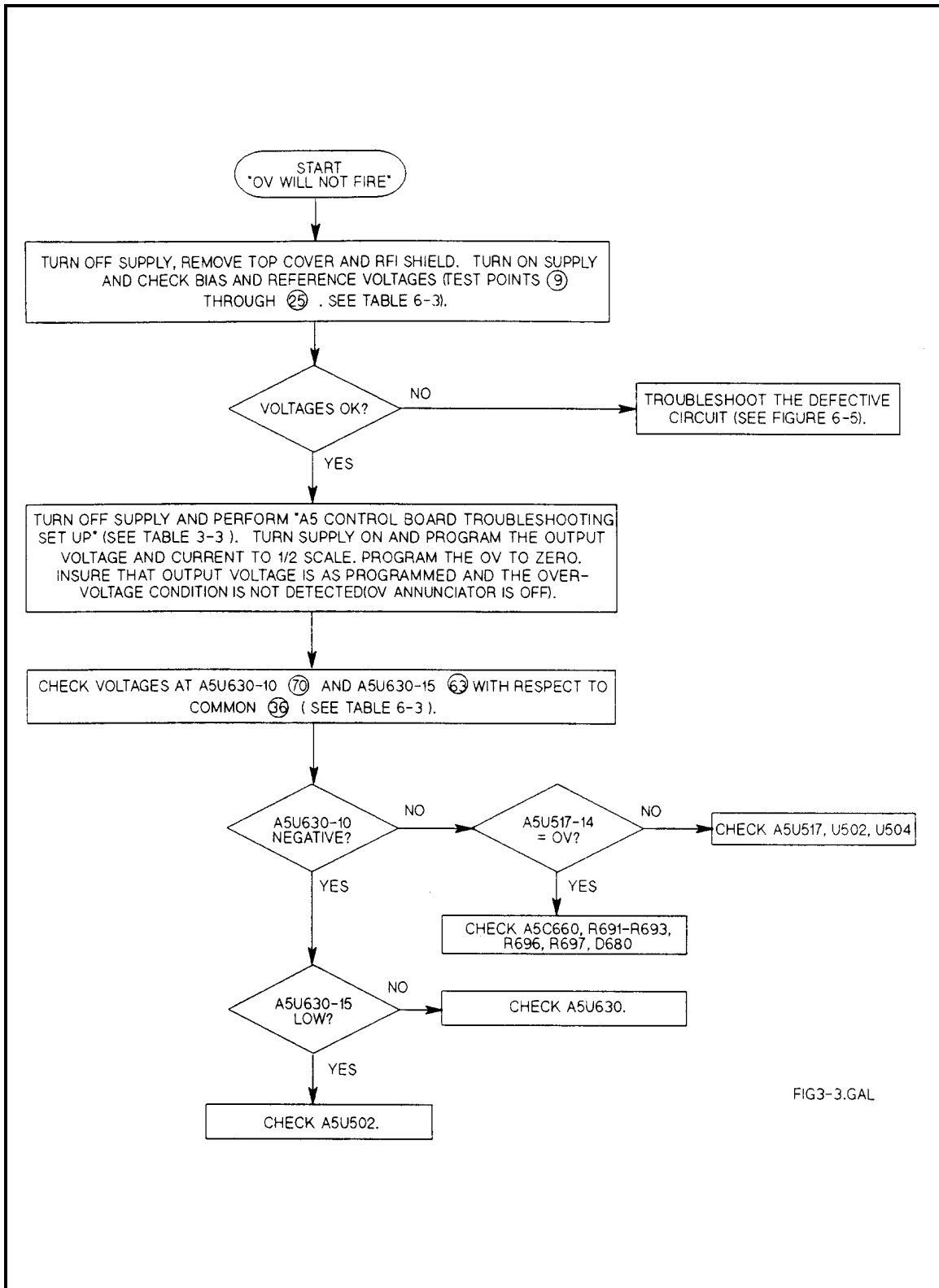

FIG3-3.GAL

Figure 3-3. OV Will Not Fire Troubleshooting

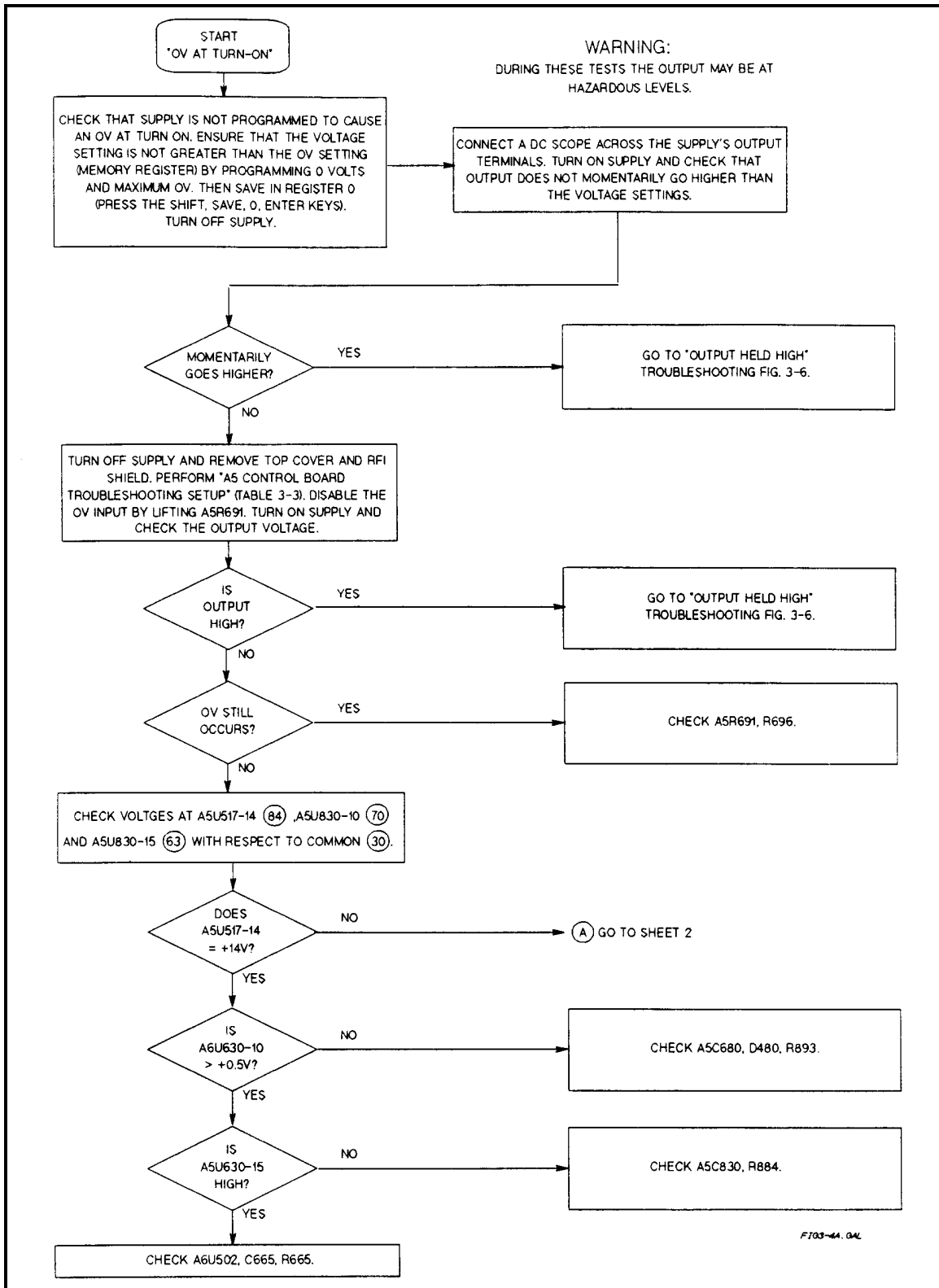

Figure 3-4. OV At Turn-On Troubleshooting (Sheet 1 of 2)

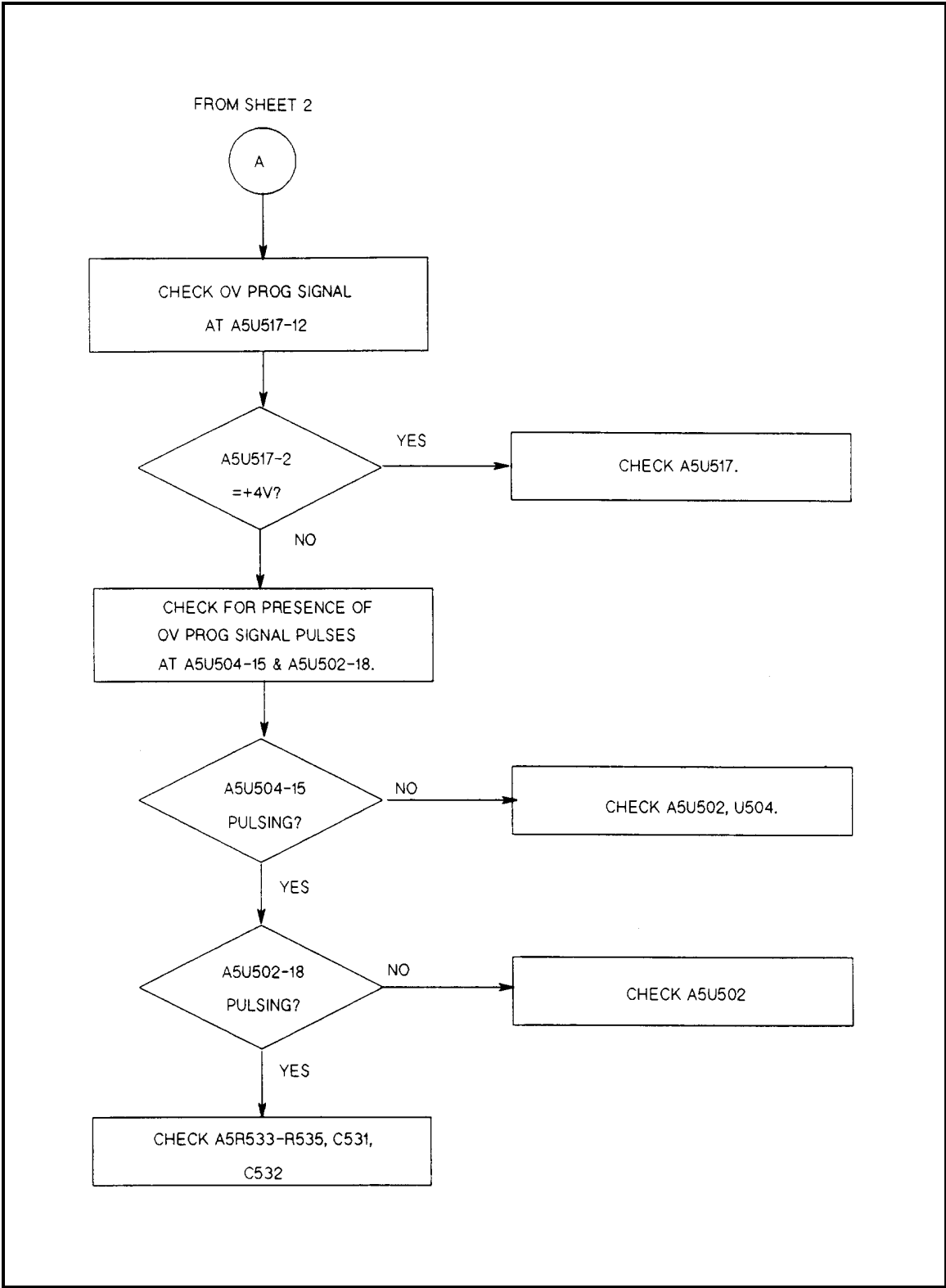

Figure 3-4. OV At Turn-On Troubleshooting (Sheet 2 of 2)

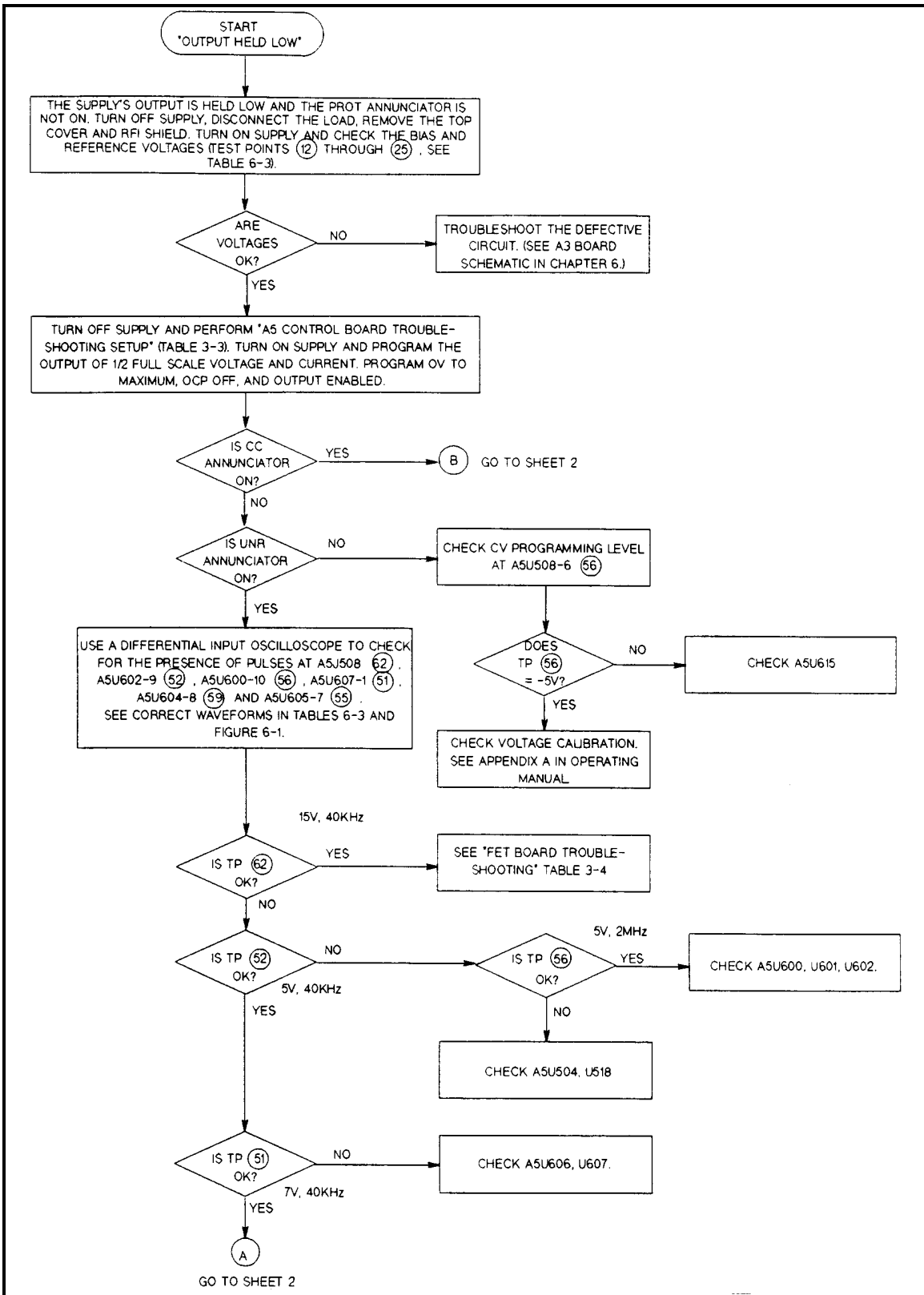

Figure 3-5. Output Held Low Troubleshooting (Sheet 1 of 2)

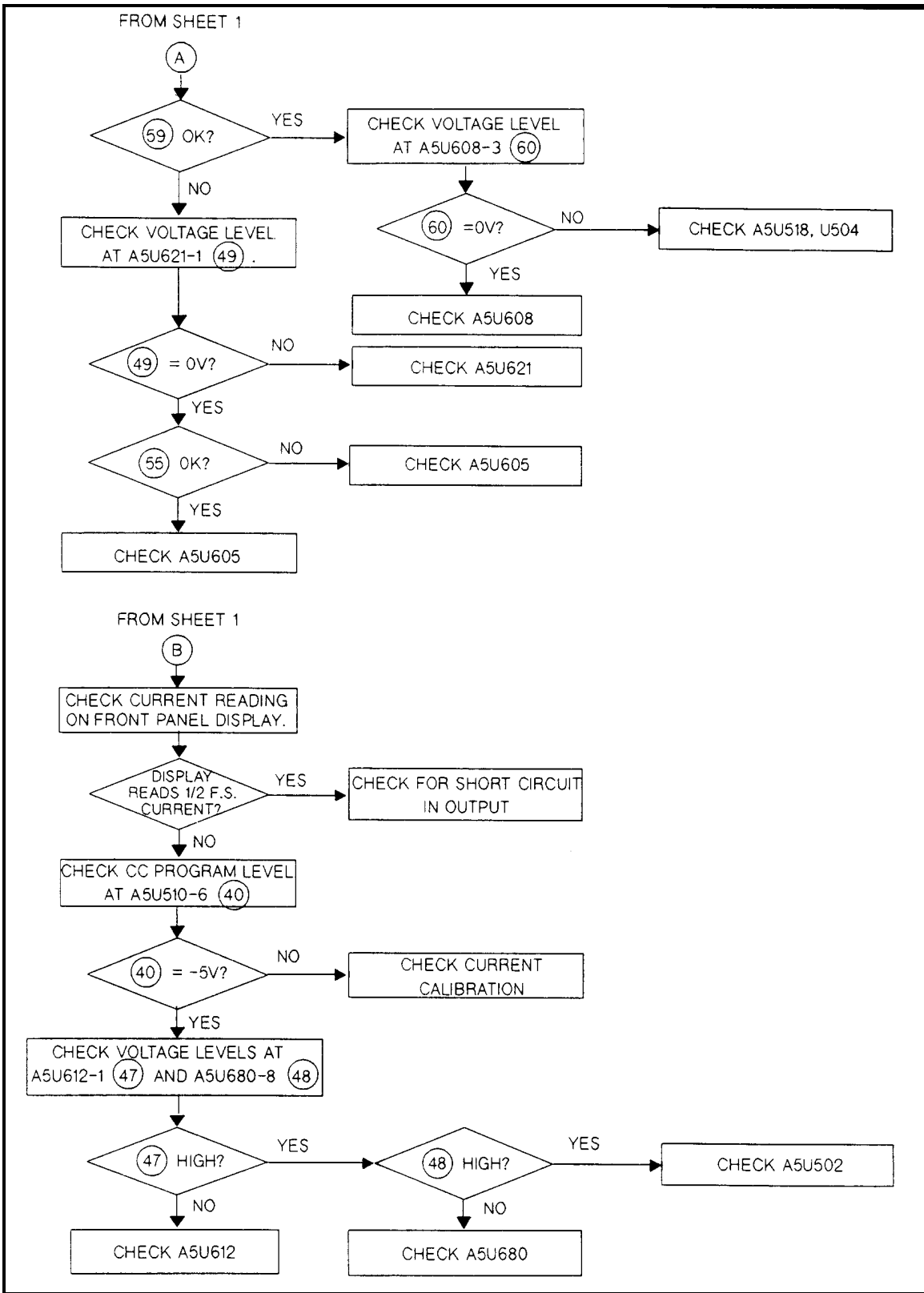

Figure 3-5. Output Held Low Troubleshooting (Sheet 2 of 2)

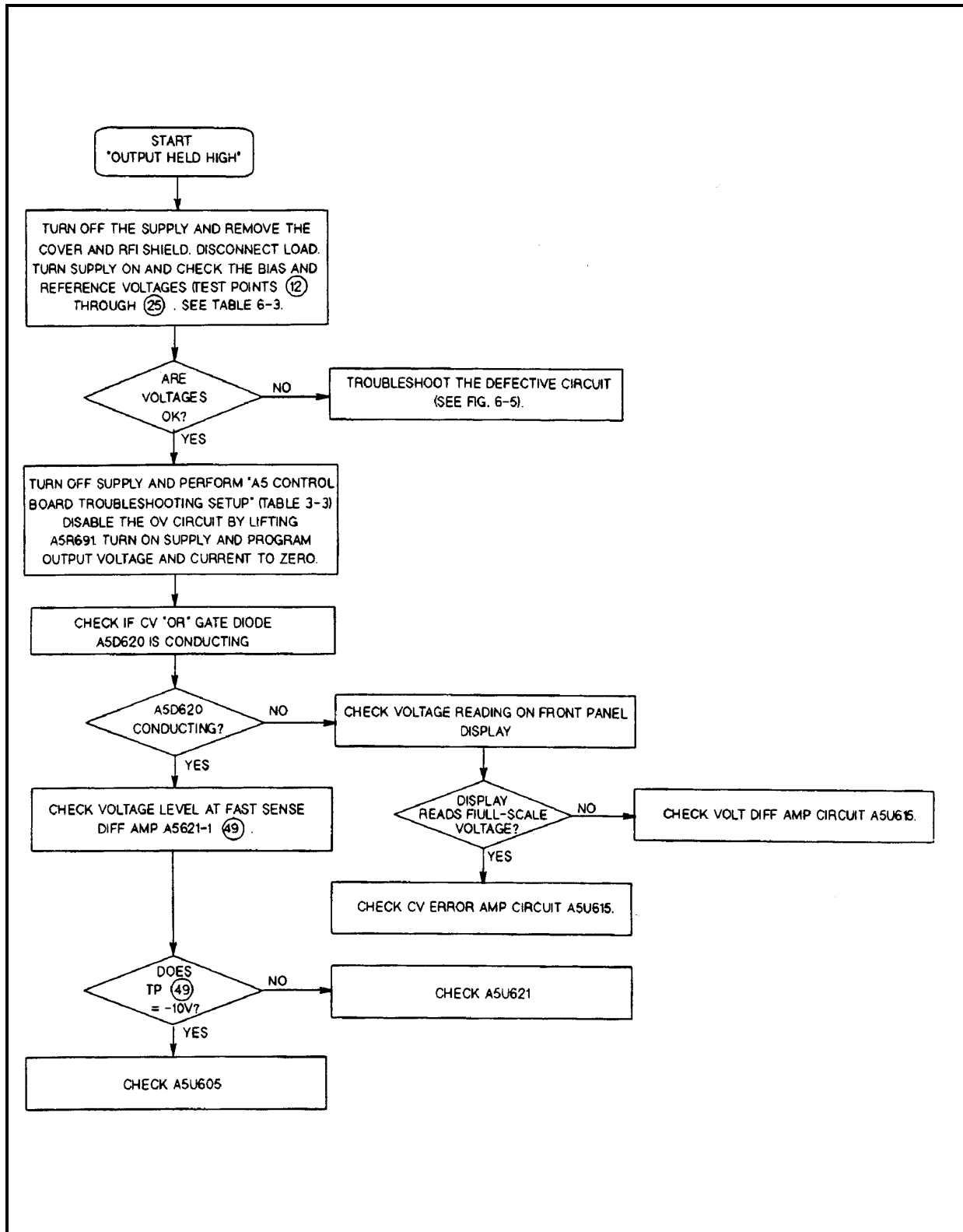

Figure 3-6. Output Held High Troubleshooting

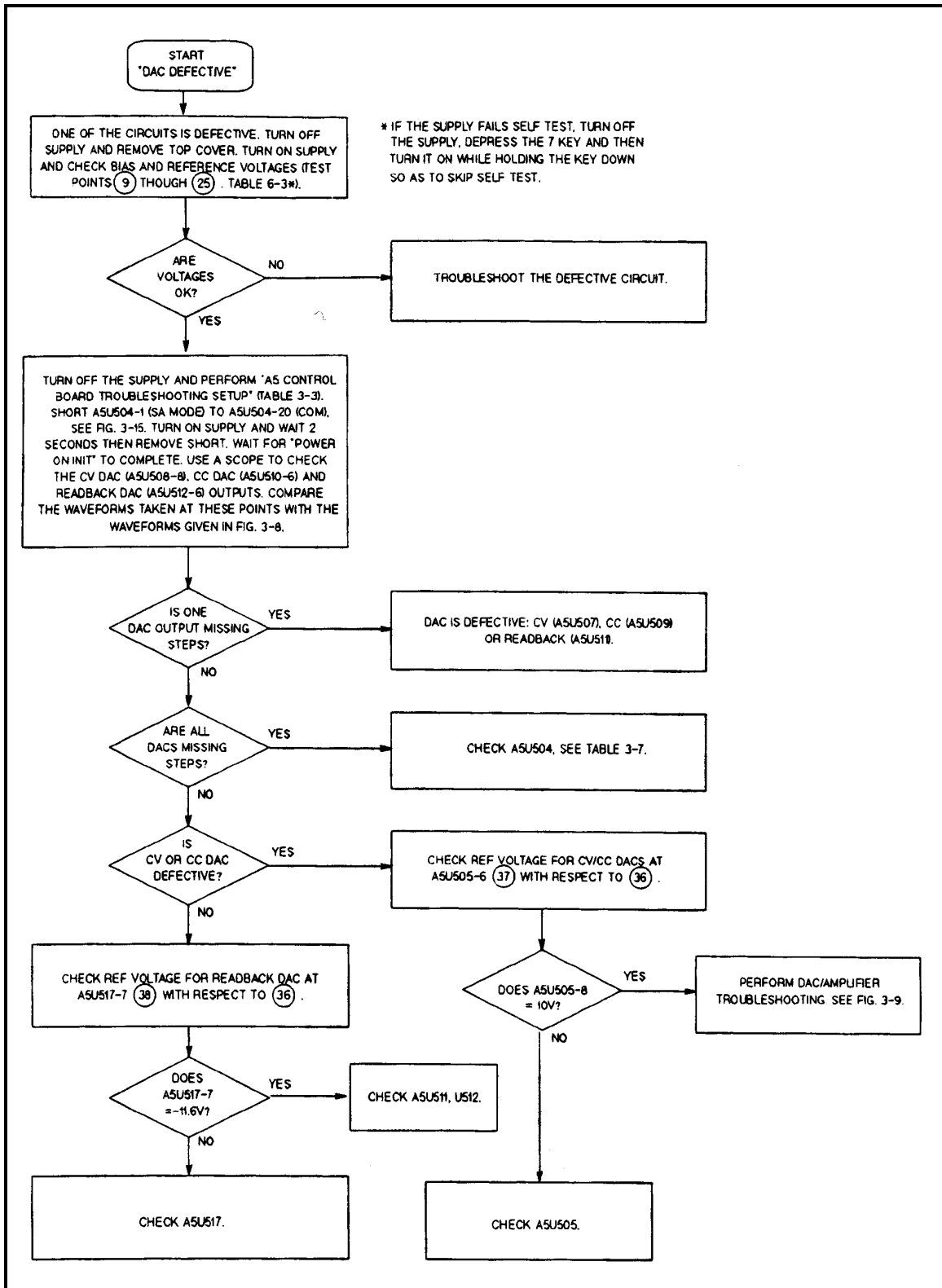
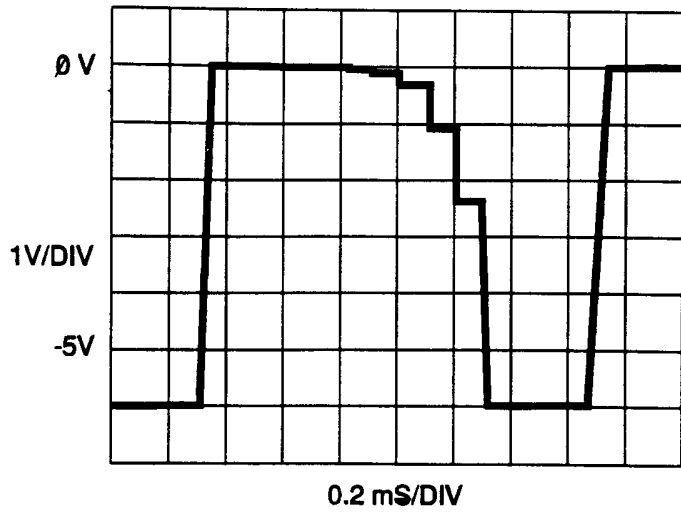
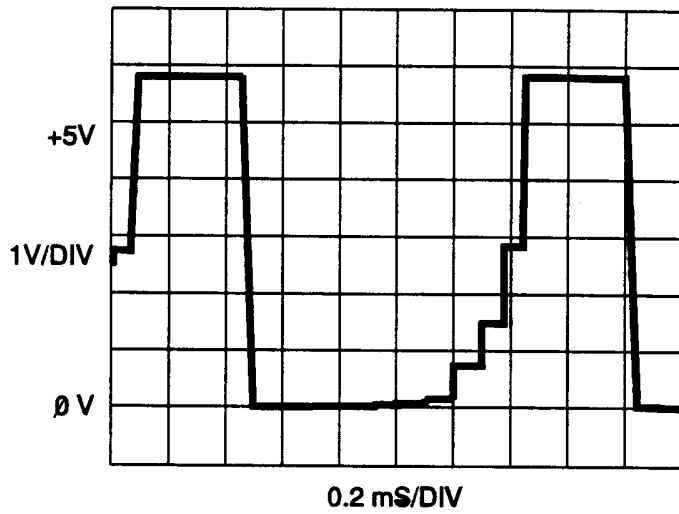

Figure 3-7. DAC Circuits Troubleshooting



A. CV DAC (U508-6) AND
CC DAC (U510-6) OUTPUTS



B. READBACK DAC (U512-6) OUTPUT

FIG3-8.GAL

Figure 3-8. DAC Test Waveforms

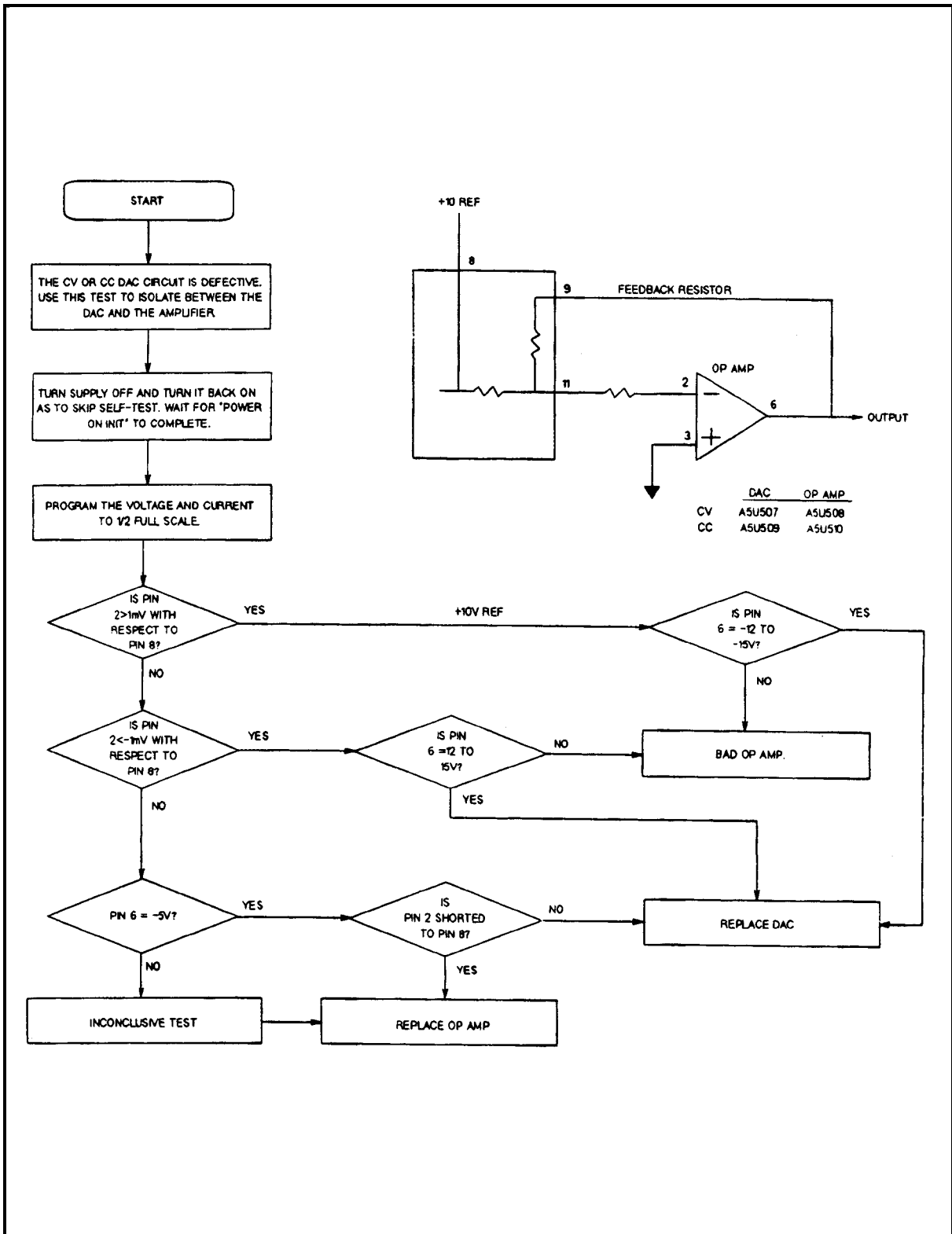

Figure 3-9. CV/CC DAC and Amplifier Circuit Troubleshooting

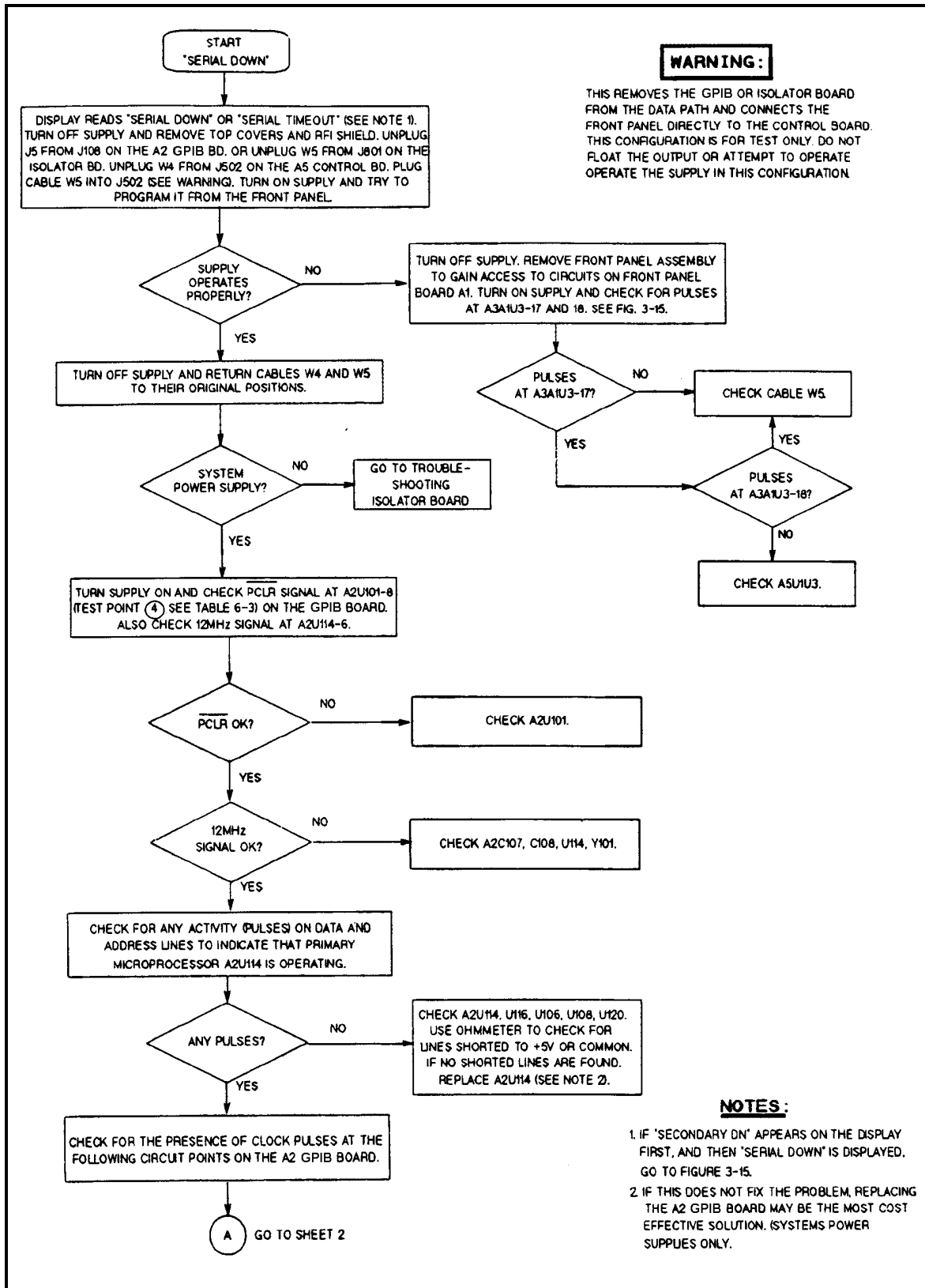

Figure 3-10. Serial Down Troubleshooting (Sheet 1 of 2)

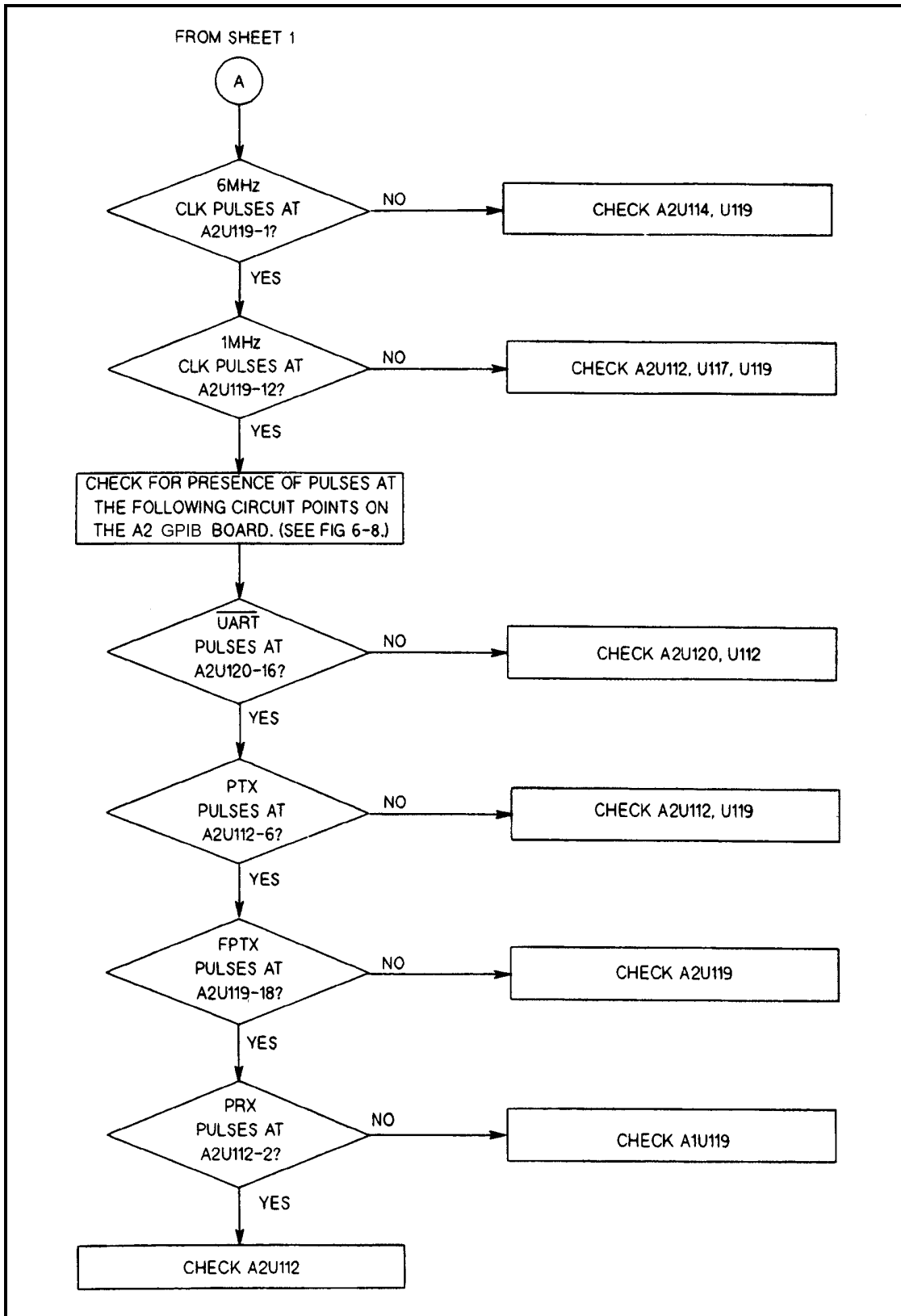

Figure 3-10. Serial Down Troubleshooting (Sheet 2 of 2)

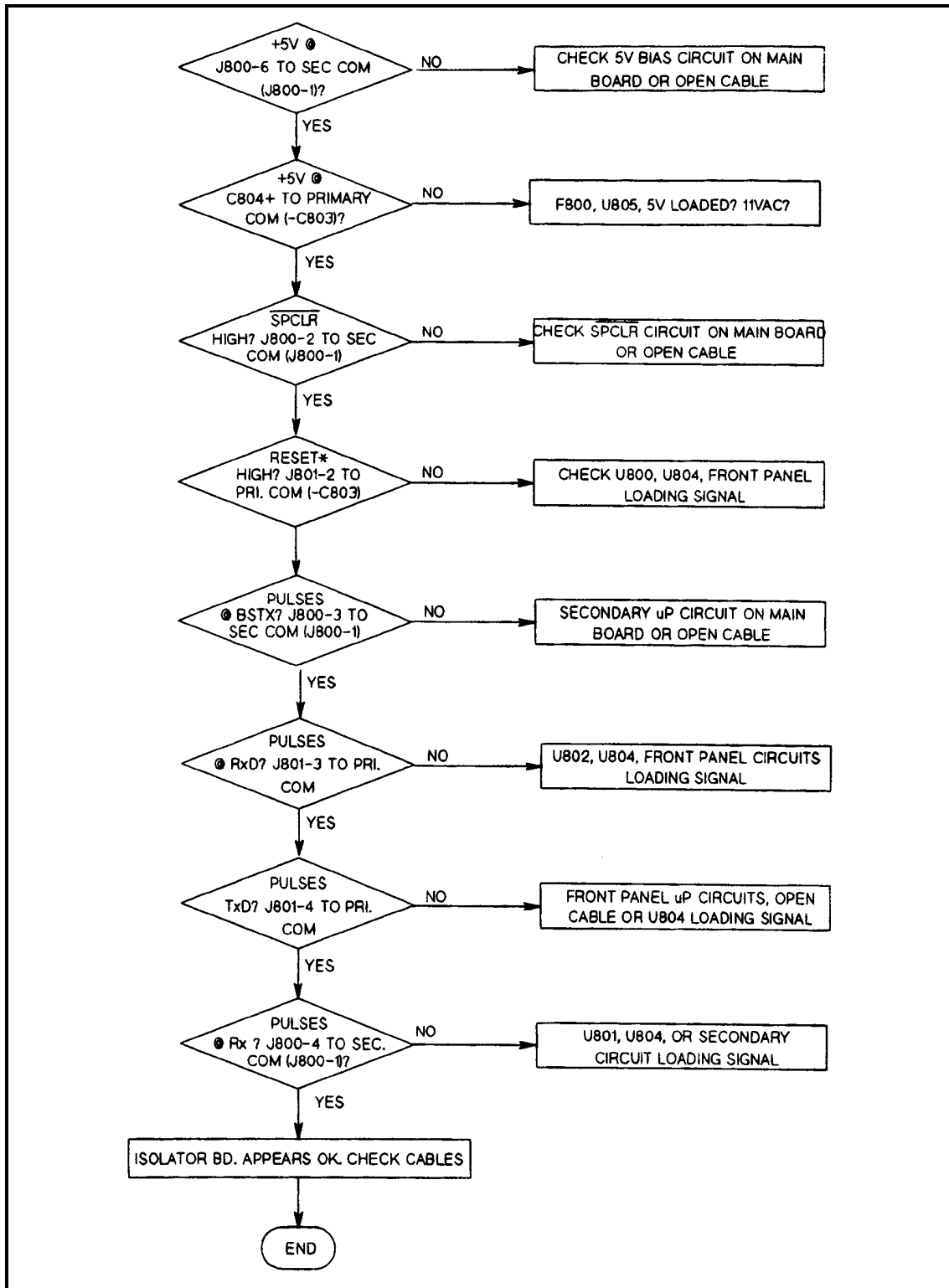

Figure 3-11. Isolator Board Troubleshooting

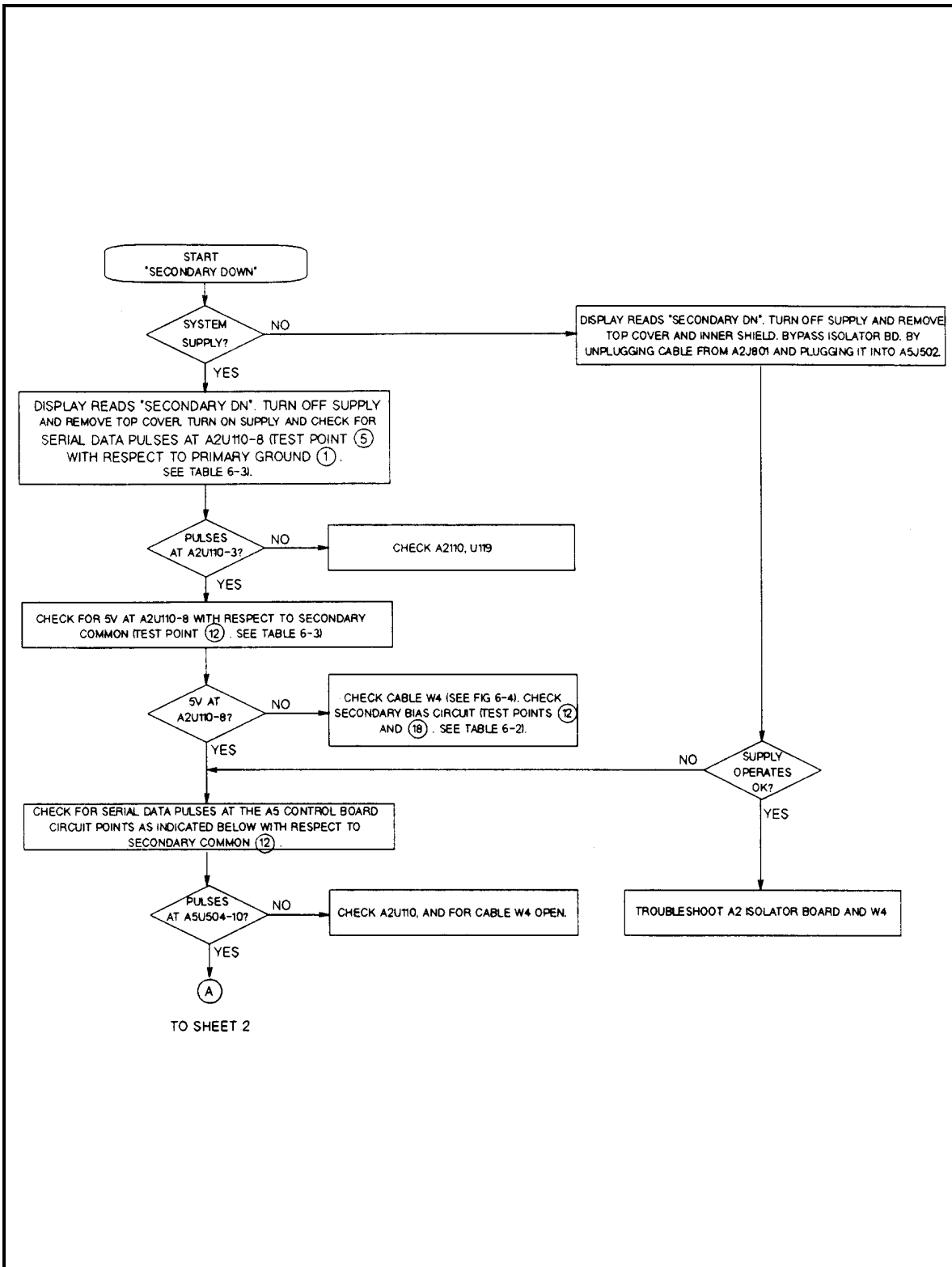

Figure 3-12. Secondary Interface Down (Sheet 1 of 2)

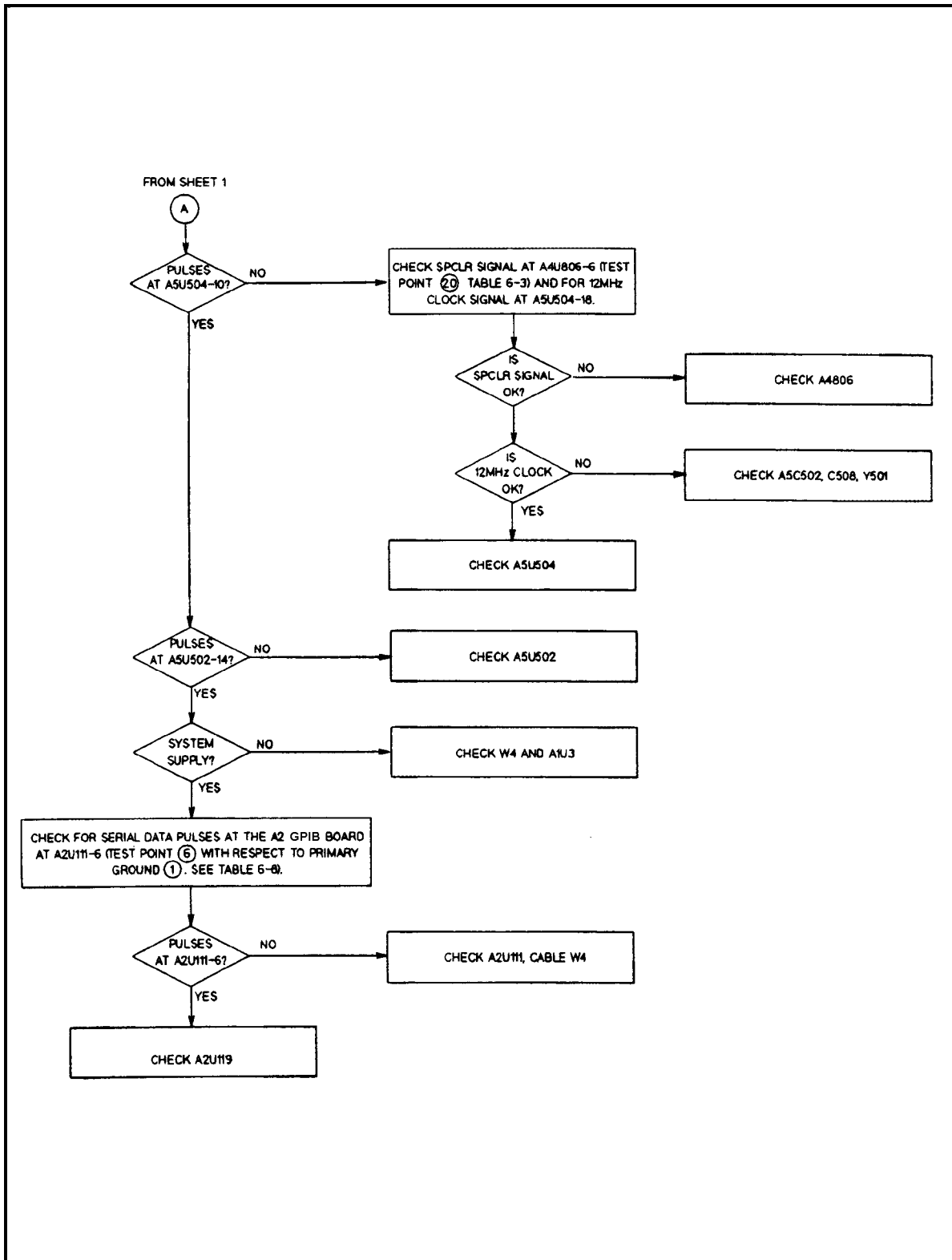

Figure 3-12. Secondary Interface Down (Sheet 2 of 2)

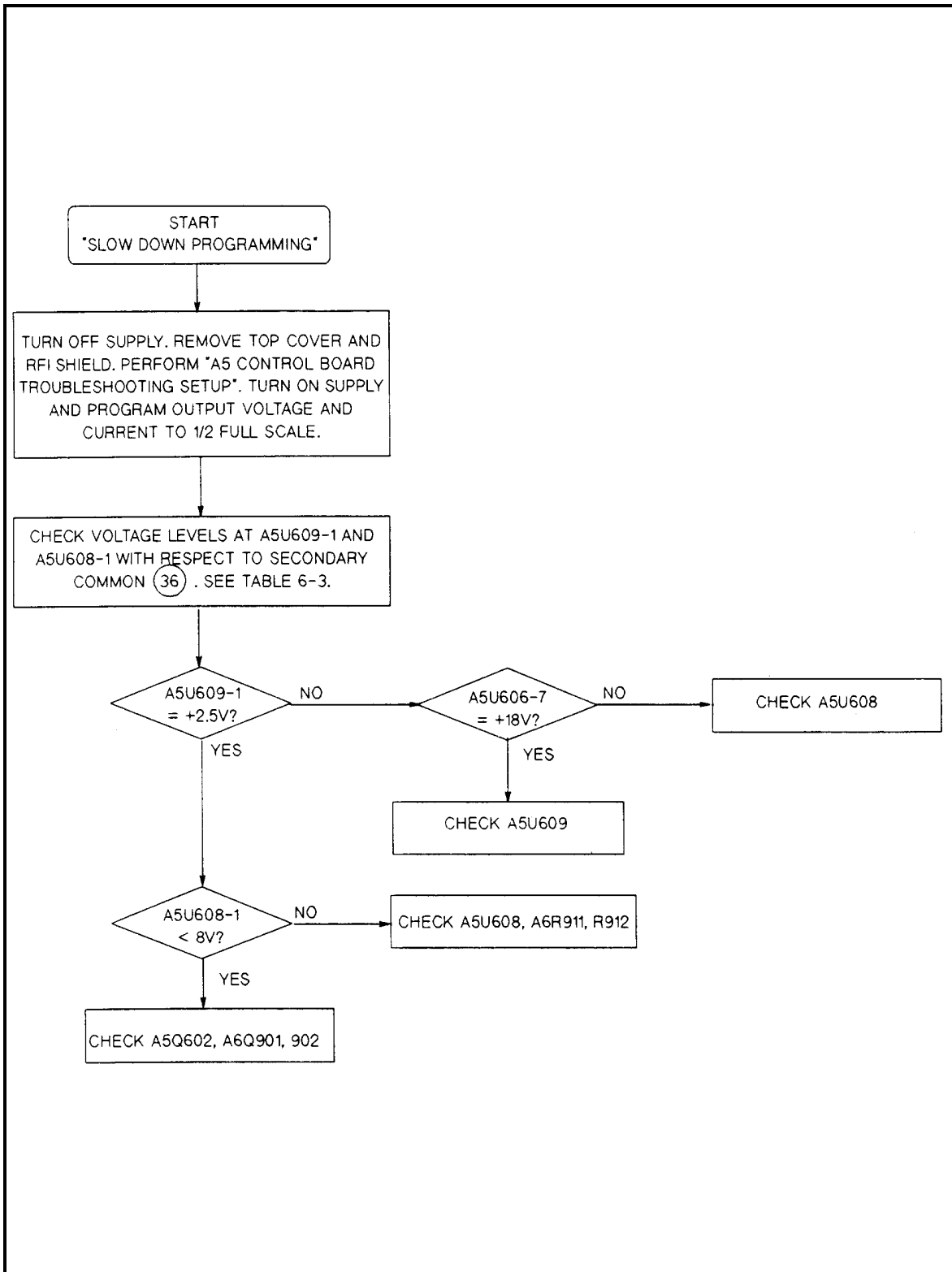

Figure 3-13. Slow Downprogramming Troubleshooting

CV/CC Status Annunciators Troubleshooting

When troubleshooting the CV/CC status annunciators or status readback circuits, first measure the voltage drop across the gating diodes, which are A5D615 for the CC circuit and A5D620 for the CV circuit (see A5 Control Board schematic diagram, Sheet 2). A conducting diode indicates an active (ON) control circuit. This forward drop is applied to the input of the associated status comparator (A5U630) and drives the output low. The low signal indicates an active status which is sent to the secondary microprocessor A5U504 via Programmed GAL A5U502 (see schematic Sheet 1). The front panel CV annunciator lights when the CV mode is active (CV is low) and the CC annunciator lights when the CC mode is active (CC is low). If neither is active, the UNREGULATED (Unr) annunciator comes on.

A5 Control Board Troubleshooting Setup

Several troubleshooting procedures in this chapter require you to gain access to the components and test points on the A5 Control Board. To do this, follow the procedure given in Table 3-3.

To gain access to components and test points on the A5 Control Board, proceed as follows:
1. Turn off power supply and remove the top cover and RFI shield (see Disassembly Procedures).
2. Remove the A5 Control Board from the output subchassis (see Disassembly Procedures).
3. Lay the board, component side up, on a piece of insulating material adjacent and close to the supply.
4. Make the following connections; <ol style="list-style-type: none"> Ribbon cable W3 from A5J509 to A4J500. Phone cable W4 from A5J502 to A2J107. Test cable (2-wire cable assembly Keysight P/N 5080-2169) from A5J503 to A3J200. Make a 12-inch test jumper cable from two 20-pin connectors (Keysight P/N's 1251-8666 and 1251-8667) and 20 feet of wire (24-26 AWG). Use the cable to connect A5J510 to A6J900.
You may now proceed with the specific tests for the A5 Control Board.

A3 FET Board Troubleshooting

Because test points on the FET board are not accessible when the board is installed, troubleshooting must be performed with the board removed from the power supply. Both static (power removed) and dynamic (power applied) troubleshooting procedures are provided. The location of different test points are shown by encircled numbers on the A3 FET Board schematic and component location diagrams (see Chapter 6).

Note	If any power FET (Q201-204, Q211, Q222, Q233 or Q244) is defective, you must replace all eight with a matched set.
-------------	--

Table 3-4. FET Troubleshooting Chart

Procedure	Result
Static Troubleshooting	
1. Turn the power supply off and remove the A3 FET board with its heatsink assembly attached (see "Disassembly Procedures").	
2. Measure the resistance between the + Rail (E502) and the - Rail (E501).	$\geq 20 \text{ M}\Omega$.
3. Measure the resistance between the gate of each FET (Q201-204, Q211, Q222, Q233, and Q244) and common (-Rail).	$>15 \text{ k}\Omega$.

Table 3-4. FET Troubleshooting Chart (continued)

Procedure	Result
Static Troubleshooting	
4. Measure the resistance across capacitor C201.	≈ 150 Ω.
5. Measure the resistance across the 15V bias input (E506 to E507).	≈ 1 kΩ in the forward direction and 490 Ω in the reverse direction.
Dynamic Troubleshooting	
1. Turn off the power supply and remove the A3 FET Board with its heat sink assembly.	See "Disassembly Procedures".
2. Short the collectors of Q251 and Q252 by connecting the collector (case) of each transistor to common (E507) .	
3. Connect waveform generator to J200-1 and J200-2.	
4. Set generator to produce a 20KHz, 20V p-p triangular waveform.	See Figure 3-14A.
5. Connect 15V from an external supply to E506 (positive) and E507 (common). Note: All of the following measurements are taken with respect to E507 common, test point (26) on A3 FET Board schematic diagram.	
6. Check bias voltage at U203-1 (27) .	+5V
7. While adjusting the external 15V supply input, check the bias trip point at U204-1 (28) .	Voltage goes from low (0V) to high (5V) at an input of approximately 12V; and from high to low at an input of approximately 13V.
8. Set external supply input to + 15V and check drive 1 waveform at U201-10 (29) and drive 2 waveform at U201-12 (30) .	See Figure 3-14B.
9. Check that pulses are present at U201-1 (31) , U201-7 (32) , U202-1 (33) , and U202-7 (34) .	See Figure 3-14C.
10. Pulses should be present on both sides of inductors L201-204 and L213-216 as follows: Check the pulses on the driver transistor side (Q251-Q254) of each inductor. Check the pulses on the FET regulator side (Q201-Q204, Q211, Q222, Q233, and Q244) of each inductor. If the waveforms do not have the fast step as shown in Figure 3-14, then the associated FET gate input has an open circuit.	See Figure 3-14D. See Figure 3-14E.
11. Measure the VREF voltage at U204-4 (35) .	≈ 1.7V
12. Check the peak current limit by connecting a 68KΩ resistor from +5V (U201-9) to U204-5.	All pulses turn off.

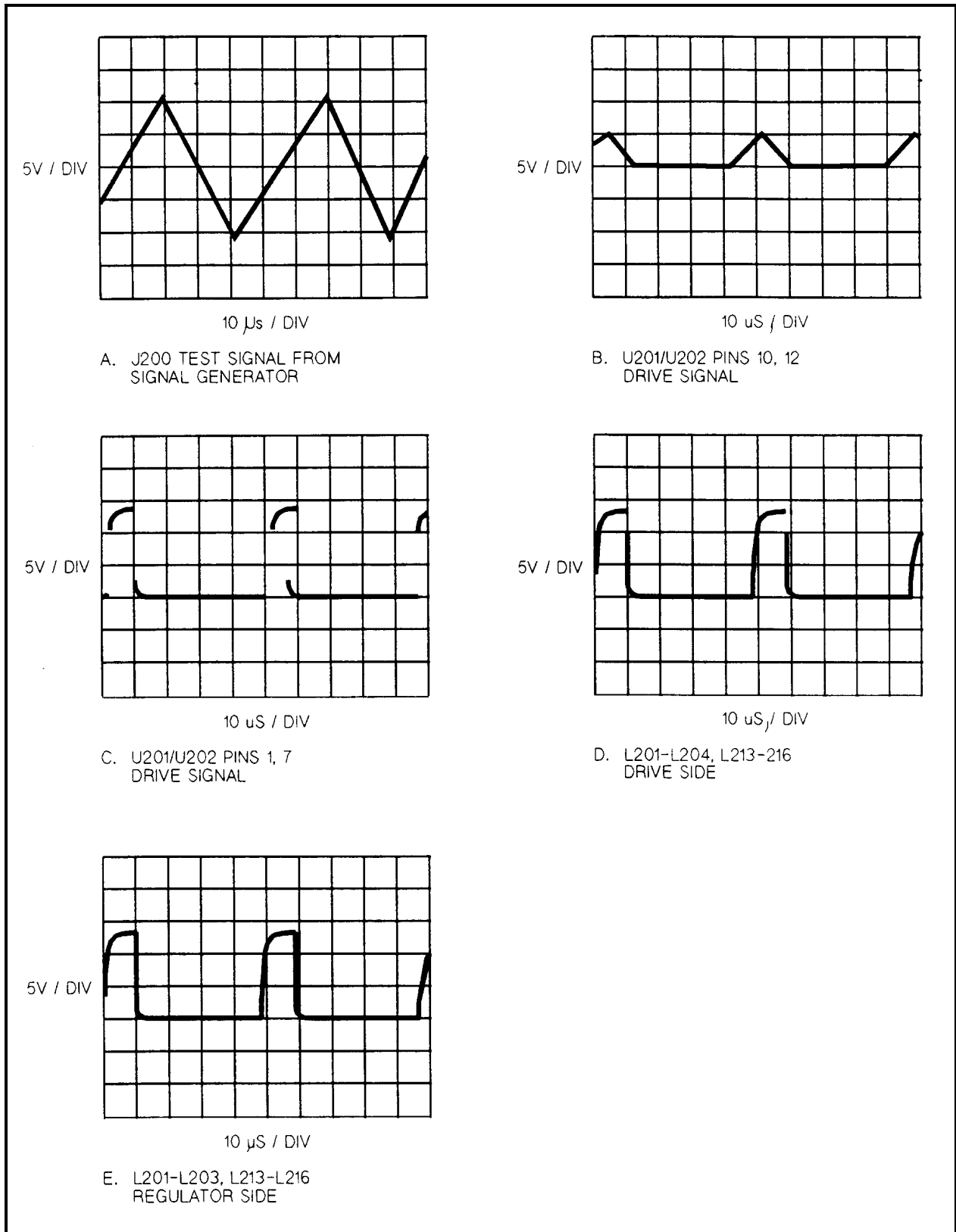

Figure 3-14. A3 FET Board Test Waveforms

Signature Analysis

Introduction

The easiest and most efficient method of troubleshooting microprocessor-based instruments is with signature analysis (SA). This technique is similar to signal tracing with an oscilloscope in linear circuits. Part of the microprocessor memory is dedicated to SA, and a known bit stream is generated to stimulate as many nodes as possible within a circuit. Because it is virtually impossible to analyze a bit stream with an oscilloscope, a signature analyzer is used to compress the bit stream into a four-character signature. By comparing the signatures of the IC under test to the correct signature for each node, you can isolate faults to one or two components .

The following general rules apply to signature analysis testing:

1. Be sure to use the correct test setup connections for the specific test.
2. When examining an IC, note the correct signatures for Vcc (+5V) and for common. If an incorrect signature matches either one, it probably indicates a short to that part of the circuit.
3. If two IC pins have identical signatures, they are probably shorted.
4. If two IC signatures are similar, it is only a coincidence.
5. If an input pin of an IC has an incorrect signal but the signal source (output of the previous IC) is correct, then look for an open printed circuit track or soldering problems.
6. If the output signature of an IC is incorrect, it could be caused by that IC. However, it could also be caused by a short at another component that is connected to that output.

Firmware Revisions

Each signature analysis table in this chapter shows the power supply firmware revision for which the table is valid. If needed, for a Bench Supply you can confirm the firmware revision of your power supply by checking the label on the Front Panel ROM, AIU3, and on the Secondary microprocessor, A5U504. You can obtain the revisions on a Systems Supply with the GPIB \$IDN? query command. The following sample Keysight BASIC program does this:

```
10 ALLOCATE L$(52)
20 OUTPUT 705;"*IDN?"
30 ENTER 705;L$
40 DISP L$
50 END
```

For a typical Model 6671A, the controller will return a string with four comma-separated fields, as follows:

```
"Keysight Technologies,6671A,0,fA.01.05sA.01.04pA.01.01"
```

The first three fields in the string are the manufacturer, model number and 0. The last field gives the firmware information as follows:

```
f= front panel firmware revision (A.01.05).
s= secondary interface firmware revision (A.01.04).
p= primary interface firmware revision (A.01.01).
```

Test Headers

The power supply has two test headers as shown in Figure 3-15, each with a jumper that can be moved to different positions for SA testing and for other functions. To gain access to the headers, remove the power supply top cover.

Pins	Description
Primary Interface Test Connector A2J106 (Systems Supplies Only)	
7 and 8 (FLT/INH)	Normal operating (and storage) position. DIG CNTL port** is configured for fault indicator (FLT) output and remote inhibit (RI) input .
1 and 2 (SA Mode)	Install jumper here for SA mode.
3 and 4 (DIG I/O)	Install jumper here to configure DIG CNTL port** for digital I/O operation .
5 and 6 (RELAY LINK)	Install jumper here to configure DIG CNTL port** for control of external relay accessories. ** See Appendix D in Power Supply Operating Manual for information about the digital control port.
Front Panel Test Connector A1J3	
7 and 8 (NORM)	Normal operating (and storage) position of jumper.
1 and 2 (SA Mode)	Install jumper here for SA mode.
3 and 4 (INHIBIT CAL)	Install jumper here to disable calibration commands and prohibit calibration.
5 and 6 (FACTORY PRESET CAL)	Install jumper here to restore original factory calibration constants.

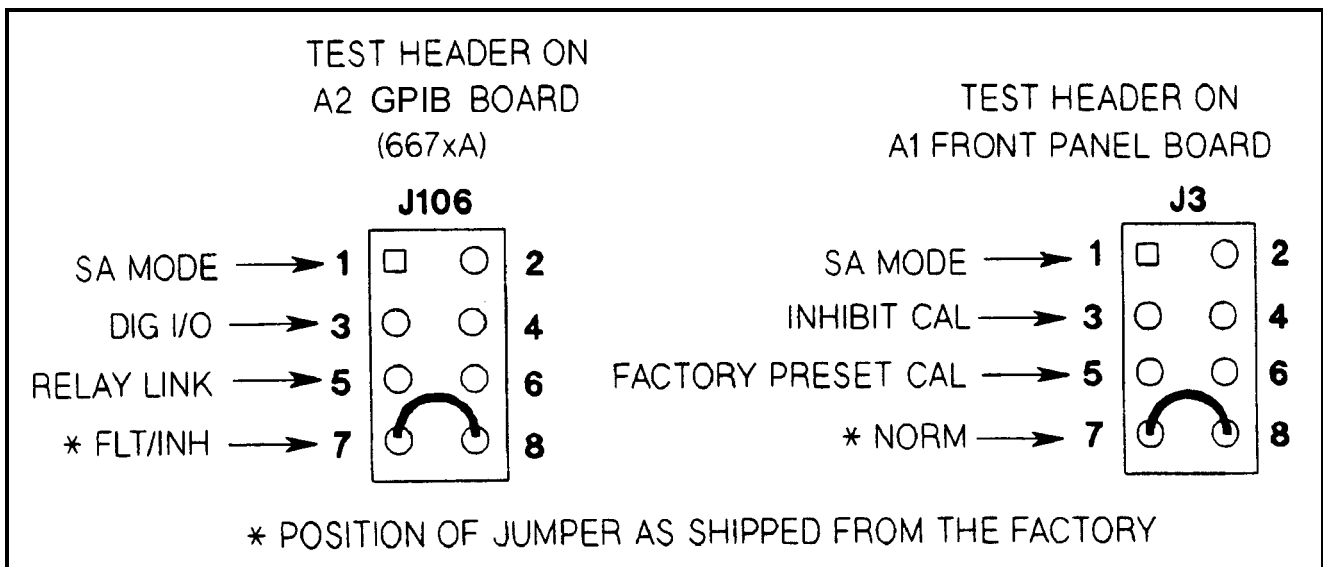

Figure 3-15. Test Header Jumper Positions

Table 3-5. Primary Interface SA Test

<p>Description: These signatures check some primary interface circuits on the Systems Supply A2 GPIB Board. Valid A2U106 ROM Firmware Revision: A.01.06 Test Setup: See Figure 3-17.</p>
1. Turn off the power supply and remove the top cover.
2. Connect SA jumper of connector J106 on A2 GPIB Board (see Figure 3-15).
3. Connect signature analyzer CLOCK, START, STOP, and GROUND inputs as show in Figure 3- 16 .
<p>4. Turn on the power supply and use the signature analyzer probe to take the following signatures:</p> <p>Power: 5V = 9FFP Serial Link: A2U109-3 = 0104 Microprocessor: A2U114-24 = 9FFP A2U114-25 = UF39 Digital Control Interface: A2U118-1 = 9AF1 A2U118-9 = 40A5 A2U118-10 = 1029 A2U118-15 = 0010 A2U118-16 = 040A Gated Array Logic: A2U119-2 = 0A55 A2U119-5 = 0040 A2U119-15 = 0040</p>
5. After completing the tests, be sure to return the J106 jumper to its original position.





Signature Analyzer Input	Edge Setting	A2 Board Connection	A1A1 Front Panel Board Connection	A10 Board Connection
CLOCK		J106-5	J2-9	U504-32
START		J106-6	J2-11	U502-7
STOP		J106-6	J2-11	U502-7
GROUND		J106-4	J2-8	U502-10

Figure 3-16. Signature Analysis Signal Inputs

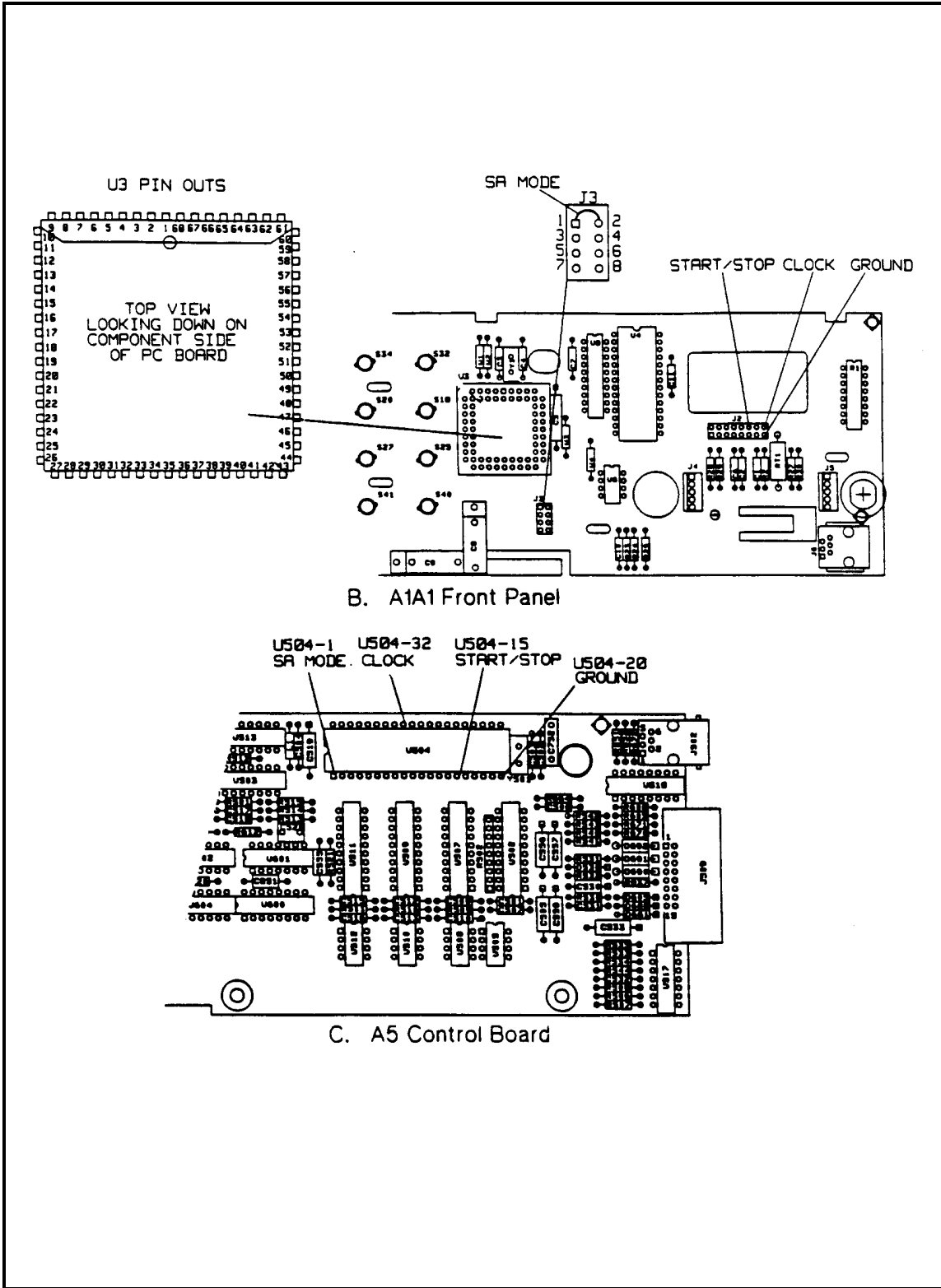

Figure 3-17. Signature Analysis Connections for Model 657xA Only

Table 3-6. Front Panel SA Test

<p>Description: These signatures check front panel microprocessor AIU3. Valid A1U4 ROM Firmware Revision: A.01.07 Test Setup: See Figure 3-17.</p>																																					
1.	Turn off the power supply and remove the top cover.																																				
2.	To gain access to A1 Front Panel Board, perform steps 1 and 2 of the disassembly procedure for A1 Front Panel Assembly (see "Disassembly Procedures").																																				
3.	Connect SA jumper of connector J3 on A1 Front Panel Board (see Figure 3-15).																																				
4.	Connect signature analyzer CLOCK, START, STOP, and GROUND inputs and setup as shown in Figure 3-16.																																				
5.	<p>Turn on the power supply and use the signature analyzer probe to take the following signatures:</p> <table border="0"> <tr> <td>Power:</td> <td>5V = 3395</td> <td></td> </tr> <tr> <td>Microprocessor:</td> <td>AIU3-15 = 0000</td> <td>AIU3-29 = 1029</td> </tr> <tr> <td></td> <td>AIU3-19 = 552U</td> <td>AIU3-30 = 0295</td> </tr> <tr> <td></td> <td>AIU3-20 = 954C</td> <td>AIU3-31 = 0000</td> </tr> <tr> <td></td> <td>AIU3-21 = A552</td> <td>AIU3-32 = 3395</td> </tr> <tr> <td></td> <td>AIU3-22 = 2954</td> <td>AIU3-33 = 0008</td> </tr> <tr> <td></td> <td>AIU3-23 = 0A55</td> <td>AIU3-34 = 040A</td> </tr> <tr> <td></td> <td>AIU3-24 = 3395</td> <td>AIU3-35 = 0102</td> </tr> <tr> <td></td> <td>AIU3-25 = 3395</td> <td>AIU3-38 = 0002</td> </tr> <tr> <td></td> <td>AIU3-26 = 0000</td> <td>AIU3-39 = 0020</td> </tr> <tr> <td></td> <td>AIU3-27 = 0000</td> <td>AIU3-42 = 0000</td> </tr> <tr> <td></td> <td>AIU3-28 = 40A5</td> <td></td> </tr> </table>	Power:	5V = 3395		Microprocessor:	AIU3-15 = 0000	AIU3-29 = 1029		AIU3-19 = 552U	AIU3-30 = 0295		AIU3-20 = 954C	AIU3-31 = 0000		AIU3-21 = A552	AIU3-32 = 3395		AIU3-22 = 2954	AIU3-33 = 0008		AIU3-23 = 0A55	AIU3-34 = 040A		AIU3-24 = 3395	AIU3-35 = 0102		AIU3-25 = 3395	AIU3-38 = 0002		AIU3-26 = 0000	AIU3-39 = 0020		AIU3-27 = 0000	AIU3-42 = 0000		AIU3-28 = 40A5	
Power:	5V = 3395																																				
Microprocessor:	AIU3-15 = 0000	AIU3-29 = 1029																																			
	AIU3-19 = 552U	AIU3-30 = 0295																																			
	AIU3-20 = 954C	AIU3-31 = 0000																																			
	AIU3-21 = A552	AIU3-32 = 3395																																			
	AIU3-22 = 2954	AIU3-33 = 0008																																			
	AIU3-23 = 0A55	AIU3-34 = 040A																																			
	AIU3-24 = 3395	AIU3-35 = 0102																																			
	AIU3-25 = 3395	AIU3-38 = 0002																																			
	AIU3-26 = 0000	AIU3-39 = 0020																																			
	AIU3-27 = 0000	AIU3-42 = 0000																																			
	AIU3-28 = 40A5																																				
6.	After completing the tests, be sure to return the J3 jumper to its original position.																																				

Table 3-7. Secondary Interface SA Test

<p>Description: These signatures check the secondary microprocessor A5U504. Valid A5U504 ROM Firmware Revision: A . 01. 04 Test Setup: See Figure 3-17.</p>																																									
1. Turn off the power supply and remove the top cover.																																									
2. To obtain a setup that allows access to components and test points on the A5 Control Board, follow the procedure given in Table 3-3 under "A5 Control Board Setup".																																									
3. Connect signature analyzer CLOCK, START, STOP, and GROUND inputs and setup as shown in Figure 3-15.																																									
4. To place the secondary interface in the SA mode, turn on the power supply while momentarily (for 2 seconds) shorting A5U504-1 to A5U504-20 (common).																																									
5. Use the signature analyzer probe to take the following signatures:																																									
Power:	5 V = IC4C																																								
Microprocessor:	<table border="0"> <tr> <td>A5U504-1 = F77H</td> <td>A5U504-21 = 0C98</td> </tr> <tr> <td>A5U504-2 = C98P</td> <td>A5U504-22 = 5PC7</td> </tr> <tr> <td>A5U504-3 = 1573</td> <td>A5U504-23 = 0000</td> </tr> <tr> <td>A5U504-4 = P42A</td> <td>A5U504-24 = 6CAP</td> </tr> <tr> <td>A5U504-5 = UHF8</td> <td>A5U504-25 = A339</td> </tr> <tr> <td>A5U504-6 = F5UC</td> <td>A5U504-26 = A319</td> </tr> <tr> <td>A5U504-7 = UH8C</td> <td>A5U504-27 = A339</td> </tr> <tr> <td>A5U504-8 = 23UC</td> <td>A5U504-28 = 0C98</td> </tr> <tr> <td>A5U504-9 = 0000</td> <td>A5U504-29 = IC4C</td> </tr> <tr> <td>A5U504-10 = IC4C</td> <td>A5U504-30 = 0000</td> </tr> <tr> <td>A5U504-11 = IC4C</td> <td>A5U504-31 = IC4C</td> </tr> <tr> <td>A5U504-12 = C76F</td> <td>A5U504-32 = 0000</td> </tr> <tr> <td>A5U504-13 = U042</td> <td>A5U504-33 = 0000</td> </tr> <tr> <td>A5U504-14 = 2189</td> <td>A5U504-34 = IC47</td> </tr> <tr> <td>A5U504-15 = IC4C</td> <td>A5U504-35 = 0000</td> </tr> <tr> <td>A5U504-16 = IC45</td> <td>A5U504-36 = 0UPU</td> </tr> <tr> <td>A5U504-17 = 0010</td> <td>A5U504-37 = UF7P</td> </tr> <tr> <td>A5U504-18 = IC4C</td> <td>A5U504-38 = 347F</td> </tr> <tr> <td>A5U504-19 = IC4C</td> <td>A5U504-39 = CP47</td> </tr> <tr> <td>A5U504-20 = 0000</td> <td>A5U504-40 = IC4C</td> </tr> </table>	A5U504-1 = F77H	A5U504-21 = 0C98	A5U504-2 = C98P	A5U504-22 = 5PC7	A5U504-3 = 1573	A5U504-23 = 0000	A5U504-4 = P42A	A5U504-24 = 6CAP	A5U504-5 = UHF8	A5U504-25 = A339	A5U504-6 = F5UC	A5U504-26 = A319	A5U504-7 = UH8C	A5U504-27 = A339	A5U504-8 = 23UC	A5U504-28 = 0C98	A5U504-9 = 0000	A5U504-29 = IC4C	A5U504-10 = IC4C	A5U504-30 = 0000	A5U504-11 = IC4C	A5U504-31 = IC4C	A5U504-12 = C76F	A5U504-32 = 0000	A5U504-13 = U042	A5U504-33 = 0000	A5U504-14 = 2189	A5U504-34 = IC47	A5U504-15 = IC4C	A5U504-35 = 0000	A5U504-16 = IC45	A5U504-36 = 0UPU	A5U504-17 = 0010	A5U504-37 = UF7P	A5U504-18 = IC4C	A5U504-38 = 347F	A5U504-19 = IC4C	A5U504-39 = CP47	A5U504-20 = 0000	A5U504-40 = IC4C
A5U504-1 = F77H	A5U504-21 = 0C98																																								
A5U504-2 = C98P	A5U504-22 = 5PC7																																								
A5U504-3 = 1573	A5U504-23 = 0000																																								
A5U504-4 = P42A	A5U504-24 = 6CAP																																								
A5U504-5 = UHF8	A5U504-25 = A339																																								
A5U504-6 = F5UC	A5U504-26 = A319																																								
A5U504-7 = UH8C	A5U504-27 = A339																																								
A5U504-8 = 23UC	A5U504-28 = 0C98																																								
A5U504-9 = 0000	A5U504-29 = IC4C																																								
A5U504-10 = IC4C	A5U504-30 = 0000																																								
A5U504-11 = IC4C	A5U504-31 = IC4C																																								
A5U504-12 = C76F	A5U504-32 = 0000																																								
A5U504-13 = U042	A5U504-33 = 0000																																								
A5U504-14 = 2189	A5U504-34 = IC47																																								
A5U504-15 = IC4C	A5U504-35 = 0000																																								
A5U504-16 = IC45	A5U504-36 = 0UPU																																								
A5U504-17 = 0010	A5U504-37 = UF7P																																								
A5U504-18 = IC4C	A5U504-38 = 347F																																								
A5U504-19 = IC4C	A5U504-39 = CP47																																								
A5U504-20 = 0000	A5U504-40 = IC4C																																								
6. After completing the tests, be sure to return the J3 jumper to its original position.																																									

Note After completing this test, you can exit the SA mode only by performing a power-on reset.

Post-Repair Calibration

When Required

Calibration is required annually and also whenever certain components are replaced. If components in any of the circuits listed below are replaced, the supply must be recalibrated.

Note For calibration procedures, see Appendix A of the Operating Manual.

Location	Component
A5 Control Board	CV/CC DACs/operational amplifiers, CV/CC control circuit amplifiers, readback DAC/operational amplifier, readback comparators.
A1 Front Panel Assy	A1 Front Panel Board or EEPROM AIU6. Note: If either of these front panel components is replaced, the power supply must first be reinitialized before calibration (see "EEPROM Initialization").

Inhibit Calibration Jumper

If **CAL DENIED** appears on the display when front panel calibration is attempted (or error code 1 occurs when GPIB calibration is attempted on a Systems Supply), the INHIBIT CAL jumper (see Figure 3-15) is installed. This prevents the power supply calibration from being changed. To calibrate the power supply first move this jumper from the INHIBIT CAL position to the NORM position.

Calibration Password

In order to enter the calibration mode, you must use the correct password as described in Appendix A of the Operating Manual. As shipped from the factory, the supply's model number (e.g., "6671") is the password. If you use an incorrect password, **PASSWD ERROR** appears on the display during front panel calibration, or error code 2 occurs during GPIB calibration, and the calibration mode is disabled. If you do not know the password, you can recover the calibration function by restoring the preset factory calibration constants as described below.

Restoring Factory Calibration Constants

This procedure allows you to recover the factory calibration constants. The ability to do this allows you to operate the power supply for troubleshooting and/or to recalibrate it as required. To restore the original factory calibration constants, proceed as follows:

- | | |
|---|--|
| 1 | Turn off the supply and remove the top cover. |
| 2 | Move the jumper in test header J3 on the A1 Front Panel Board from the NORM to the FACTORY PRESET CAL position (see Figure 3-15). |
| 3 | Turn on the power supply and note that ADDR 5 and then PWR ON INIT appear briefly on the front panel display. |
| 4 | When PWR ON INIT no longer appears, the supply's factory calibration constants have been restored and the password has been changed to 0. There is no longer any password protection. You can now turn off the supply and restore the calibration jumper to the NORM position (see Figure 3-15). |
| 5 | Turn on the supply. You may now set a new password (if desired) and recalibrate the power supply. |

EEPROM Initialization

EEPROM AIU6 on the A1 Front Panel Board stores the supply's GPIB address, model number, and constants required to program and calibrate the power supply. If either the front panel board or the EEPROM is replaced, the power supply must be reinitialized with the proper constants by running the program listed in Figure 3-18.

When the program pauses and asks you to make a selection, respond as follows:

Initialization (I) or Factory Preset Replacement (F)? I

After the power supply has been initialized, *it must be calibrated* as described in Appendix A of the Operating Manual. After calibration, transfer the new calibration constants to the EEPROM's "Factory Cal" locations as described next.

Transferring Calibration Constants To Factory Preset Locations

A newly initialized and calibrated power supply has calibration constants in operating locations but does not have the new factory calibration constants stored in EEPROM. This procedure transfers the calibration constants into the EEPROM FACTORY PRESET CAL locations by running the program listed in Figure 3-18.

When the initialization program pauses and asks you to make a selection, respond as follows:

Initialization (I) or Factory Preset Replacement (F)? F

The new calibration constants will then be stored. Pre-initialized and tested A1 Front Panel boards are available for Analog Programmable "bench" series supplies. (see Chapter 5, Table 5-4 for part numbers.)

A Bench Series Supply can be initialized and the new Factory Preset calibration constants loaded by temporarily replacing the A2 Isolator board with an A2 GPIB board. Then follow the instructions above for "EEPROM INITIALIZATION" and also "TRANSFERRING CALIBRATION CONSTANTS TO THE FACTORY PRESET LOCATIONS" described above.

After the supply has been Initialized, Calibrated, and the new Factory Presets stored, remove the GPIB board and reinstall the original Isolator board.

```
10  ! Program to initialize EPROM or move factory preset data in 657xA
20  ! and 667xA power supplies.
30  ! RE-STORE " INIT_2KW"
40  ! Rev A.00.00 dated June 28, 1993
50  !
60  DIM Init_data(1:45),Model${5},Idn${21},Cal_data${40}
70  INTEGER Addr(1:45),Length(1:45)
80  ASSIGN @Ps TO 705                ! Supply must be at address 705
90  CLEAR SCREEN
100 !
110 Eprom_data_addr:                ! Data address
120 DATA 2,6,10,14,18,19,20,24,28,32
130 DATA 36,37,38,42,46,50,54,55,56,57
140 DATA 64,68,72,76,80,150,152,153,154,155
```

Figure 3-18. Initialization and Factory Preset Replacement Program Listing (Sheet 1 of 6)

```

150 DATA 156,158,160,162,163,164,165,166,167,168
160 DATA 169,170,171,172,174
170 !
180 Eprom_data_len: ! Data for word length
190 DATA 4,4,4,4,1,1,4,4,4,4
200 DATA 1,1,4,4,4,4,1,1,1,1
210 DATA 4,4,4,4,4,2,1,1,1,1
220 DATA 2,2,2,1,1,1,1,1,1,1
230 DATA 1,1,1,2,1
240 !
250 Eprom_data_6x71: ! EEPROM data for 6571A and 6671A
260 DATA 459,70,8.19,0,83,0,14.561,39.45,225.23,0
270 DATA 98,3,88.65,0,10,0,83,255,20,10
280 DATA 6571,455,168,13.7,163,1768,5,255,0,0
290 DATA 1296,6571,0,20,180,20,180,175,33,98
300 DATA 115,30,20,1,58
310 !
320 Eprom_data_6x72: ! EEPROM data for 6572A and 6672A
330 DATA 181,75.038,20.475,0,99,0,31,88.988,102.375,0
340 DATA 82,1,35.416,18,24,0,99,255,20,10
350 DATA 6572,161,500,31,500,1768,5,255,0,0
360 DATA 1296,6572,0,20,180,20,180,175,33,98
370 DATA 115,30,20,1,58
380 !
390 Eprom_data_6x73: ! EEPROM data for 6573A and 6673A
400 DATA 111,16.35,35.8,0,99,0,53.39,100,61.5,0
410 DATA 82,1,18.68,79.5,42,0,99,255,20,10
420 DATA 6573,92,166.322,52,162.759,11768,5,255,0,0
430 DATA 1296,6573,0,20,180,20,180,175,33,98
440 DATA 115,30,20,1,58
450 !
460 Eprom_data_6x74: ! EPROM data for 6574A and 6674A
470 DATA 60,70,61.425,0,82,0,80,70,35.83,0
480 DATA 99,1,11.4,0,72,0,82,255,20,10
490 DATA 6574,55,500,90,500,1768,5,255,0,0
500 DATA 1296,6574,0,20,180,20,180,175,33,98
510 DATA 115,30,20,1,58
520 !
530 Eprom_data_6x75: ! EEPROM data for 6575A and 6675A
540 DATA 29,85,123,0,82,0,179,84,18.5,0
550 DATA 99,1,5.069,130.25,144,0,82,255,20,10
560 DATA 6575,27,646,170,645,1768,5,255,0,0
570 DATA 1296,6575,0,20,180,20,180,175,33,98
580 DATA 115,50,20,1,58
590 !
600 INPUT "Input Power Supply model number. Example: ""6671A""",Model$
610 Model$=TRIM$(UPC$(Model$))
620 CLEAR SCREEN
630 !
640 RESTORE Eprom_data_addr

```

Figure 3-18. Initialization and Factory Preset Replacement Program Listing (Sheet 2 of 6)

```

650      !
660      FOR I=1 TO 45
670          READ Addr(I)
680      NEXT I
690      !
700      RESTORE Eprom_data_len
710      !
720      FOR I=1 TO 45
730          READ Length(I)
740      NEXT I
750      !
760      SELECT Model$
770      !
780      CASE "6571A"
790          RESTORE Eprom_data_6x71
800      CASE "6572A"
810          RESTORE Eprom_data_6x72
820      CASE "6573A"
830          RESTORE Eprom_data_6x73
840      CASE "6574A"
850          RESTORE Eprom_data_6x74
860      CASE "6575A"
870          RESTORE Eprom_data_6x75
880      !
890      CASE "6671A"
900          RESTORE Eprom_data_6x71
910      CASE "6672A"
920          RESTORE Eprom_data_6x72
930      CASE "6673A"
940          RESTORE Eprom_data_6x73
950      CASE "6674A"
960          RESTORE Eprom_data_6x74
970      CASE "6675A"
980          RESTORE Eprom_data_6x75
990      !
1000     CASE ELSE
1010         PRINT "Model number not found. Program is for Keysight Models"
1020         PRINT "6571A, 6572A, 6573A, 6574A and 6575A"
1030         PRINT "6671A, 6672A, 6673A, 6674A and 6675A"
1040         STOP
1050     END SELECT
1060     !
1070     FOR I=1 TO 45                                     ! Read model dependent data
1080         READ Init_data(I)
1090         IF I=21 OR I=32 THEN Init_data(I)=VAL(Model$)
1100     NEXT I
1110     !
1120     OUTPUT @Ps;"*CLS"
1130     !
1140     OUTPUT @Ps;"CAL:STATE ON,"                       ! Turn on cal mode, "0" passcode

```

Figure 3-18. Initialization and Factory Preset Replacement Program Listing (Sheet 3 of 6)

```

1150 !
1160 GOSUB Ps_error ! Error if passcode is not "0" !
1170 IF Err THEN
1180     OUTPUT @Ps;"*IDN" ! Get data from # location
1190     ENTER @Ps;Idn$
1200     Model=VAL(Idn$[POS(Idn$,"")+1])
1210 ELSE
1220     GOTO START
1230 END IF
1240 !
1250     OUTPUT @Ps;"CAL:STATE ON, ";Model ! Turn on cal mode, passcode =
1260 ! data at model number location
1270 !
1280     GOSUB Ps_error ! Error if passcode is not same as
1290 ! data at model # location
1300     IF Err THEN
1310     OUTPUT @Ps;"CAL:STATE ON, ";Model$[1,4] ! Turn on cal mode, passcode =
1320 ! model #
1330     GOSUB Ps_error
1340     IF Err THEN
1350     PRINT "Change pass code to the power supply model # or zero then restart the program."
1360     STOP
1370     ELSE
1380     GOTO Start
1390     END IF
1400 END IF
1410 !
1420 Start: !
1430 !
1440 !
1450 INPUT "Select Initialization (I) or Factory preset replacement (F).",Sel$
1460 CLEAR SCREEN
1470 SELECT (UPC$(Sel$))
1480 CASE "I" ! Select Initialization
1490     GOTO Init_eeprom
1500 CASE "F" ! Select install new factory data
1510     GOTO Fact_preset
1520 CASE ELSE
1530     BEEP
1540     GOTO Start
1550 END SELECT
1560 !
1570 Init_eeprom: !
1580 PRINT "Initializing EEPROM"
1590 !
1600 FOR I=1 TO 45
1610     OUTPUT @Ps;"DIAG:EEPR ";Addr(I);";Length(I);";Init_data(I)
1620 NEXT I
1630 GOTO Cal_off
1640 !

```

Figure 3-18. Initialization and Factory Preset Replacement Program Listing (Sheet 4 of 6)

```

1650  !
1660 Fact_preset:      !
1670  CLEAR SCREEN
1680  PRINT "This program should ONLY be completed if your power supply"
1690  PRINT "EEPROM has been replaced or a component that will effect"
1700  PRINT "the calibration AND the alignment of voltage, overvoltage"
1710  PRINT "and current is complete AND unit has passed the performance"
1720  PRINT "test.          Enter C to continue, any other key to abort."
1730  INPUT Cont_prog$
1740  IF (UPC$(Cont_prog$))<>"C" THEN GOTO Cal_off
1750  !
1760  CLEAR SCREEN
1770  PRINT "Transferring calibration data to factory preset locations."
1780  !
1790 Fact_cal_sour:    ! Address of factory calibration data source
1800  DATA 2,6,68,72,20,24,76,80,150
1810  !
1820 Fact_cal_dest:   ! Address of factory calibration data destination
1830  DATA 84,88,92,96,100,104,108,112,116
1840  !
1850 Fact_cal_len:    ! Length of factory calibration data
1860  DATA 4,4,4,4,4,4,4,4,2
1870  !
1880  RESTORE Fact_cal_sour
1890  FOR I=1 TO 9
1900    READ Cal_sour_addr(I)
1910  NEXT I
1920  !
1930  RESTORE Fact_cal_dest
1940  FOR I=1 TO 9
1950    READ Cal_dest_addr(I)
1960  NEXT I
1970  !
1980  RESTORE Fact_cal_len
1990  FOR I=1 TO 9
2000    READ Cal_length(I)
2010  NEXT I
2020  !
2030  FOR I=1 TO 9                                ! Locations of good data
2040    OUTPUT @Ps;"DIAG:EEPR? ";Cal_sour_addr(I);",";Cal_length(I)  ! Read good data
2050    ENTER @Ps;Cal_data$                                ! Enter good data
2060    OUTPUT @Ps;"DIAG:EEPR";Cal_dest_addr(I);",";Cal_length(I);",";Cal_data$
! Write good data to factory preset locations
2070  NEXT I
2080  !
2090  !
2100 Cal_off
2110  CLEAR SCREEN
2120  OUTPUT @Ps;"CAL:STATE OFF"                    ! Turn off cal mode
2130  !
2140  GOSUB Ps_error                                ! Check for errors

```

Figure 3-18. Initialization and Factory Preset Replacement Program Listing (Sheet 5 of 6)

```

2150 IF Err THEN
2160     PRINT "An error occurred during the EEPROM read/write, Check for"
2170     PRINT "programming errors. Initialization data may be incorrect."
2180     STOP
2190 END IF
2200 !
2210 PRINT "Operation complete. Program stopped."
2220 STOP
2230 !
2240 Ps_error:                ! Error handling subroutine
2250 OUTPUT @Ps;"SYST:ERR?"   ! Check for errors
2260 ENTER @Ps;Err
2270 RETURN
2280 !
2290 END

```

Figure 3-18. Initialization and Factory Preset Replacement Program Listing (Sheet 6 of 6)

Disassembly Procedures

WARNING

Shock Hazard: To avoid the possibility of personal injury, remove the power supply from service before removing the top cover. Turn off the ac power and disconnect the line cord, GPIB cable, load leads, and remote sense leads before attempting any disassembly.

Cable connections are shown in Figure 6-2 of Chapter 6 and component part numbers are given in Chapter 5. Reassembly procedures are essentially the reverse of the corresponding disassembly procedures.

CAUTION

Most of the attaching hardware is metric. Use of other types of fasteners will damage threaded inserts. Older power supplies use TORX screws for securing the carrying straps. When removing or installing these screws, use TORX screwdriver size T-15 unless T-10 is specified.

Top Cover

1. Remove the four screws that secure both the carrying straps and the cover to the chassis.
2. Spread the bottom rear of the cover and then pull back to disengage it from the front panel.
3. Remove the cover by sliding it back towards the rear of the power supply.

WARNING

Shock Hazard: Hazardous voltage can remain inside the power supply even after it has been turned off. Check the INPUT RAIL LED (A4CR402) under the RFI shield (see Figure 3-20). If the LED is on, there is still hazardous voltage inside the supply. Wait until the LED goes off (approximately 7 minutes after power is removed) before proceeding.

RFI Shield

The RFI shield covers most components on the A3 through A6 circuit boards, as well as, many of the chassis-mounted components. Remove the shield as follows:

1. Remove four screws on each side securing shield to chassis.
2. Lift the RF shield out of the chassis.
3. Connect a dc voltmeter across A4TP1 and A4TP2 (see Figure 3-19). When the reading is 42 volts or less, it is safe to work inside the power supply.

Front Panel Assembly

1. Peel off vinyl trim (one strip on each side of front panel) to access the four screws that secure the front panel assembly to the chassis.
2. Remove the four screws (two on each side) using a size T-10 TORX.
3. Disconnect phone cable W5 from J6 on the A1 Front Panel Board.
4. Record the color code and the location of each of the four wires connected to line switch S1.
5. Disconnect the wires from the switch assembly.
6. Remove the front panel assembly.

S1 Line Switch

1. Remove Front Panel Assembly and disconnect switch wires as described in that procedure.
2. Release the switch locking tabs by pressing them inward against the body of the switch and removing the switch.

A1 Front Panel Board

1. Remove the Front Panel Assembly and disconnect the switch as described under "Front Panel Assembly".
2. Disconnect LCD display ribbon cable W2 from J2 on the A1 Front Panel Board.

Note When reinstalling the LCD ribbon cable, be sure to line up the "stripe" of the ribbon cable with pin 1 on J2.

3. Use a small Allen wrench (0.050") to loosen the set screws that are inset in the knobs. (These are the A1G1 and A1G2 Voltage/Current control shafts that extend through the front panel.) Remove knobs and shaft bushings.

Note Be careful not to unscrew the knob set screws too far out as they can easily fall out of the knob and become lost.

4. Remove screw (if installed) that secures board to the Front Panel Assembly. The screw is located near J4 on the Front Panel Board.
5. Lift tab (near J6 on front panel board) and slide left to release board from the A1 Front Panel Assembly and remove board.

A1DSP1 LCD Display

1. Remove the A1 Front Panel Board as described in that procedure.
2. Remove the nuts securing the LCD display to the front panel assembly and remove the LCD and attached ribbon cable (see CAUTION below). (When reinstalling this cable, be sure to line up the cable stripe over the LCD connector pin marked with a square.)



The display connector is fragile. When removing the cable from the LCD display, carefully rock the cable connector back and forth while gently pulling it back.

A1G1 and A1G2 Rotary Controls

1. Remove the A1 Front Panel Board as described in that procedure.
2. Remove the A1G1 and A1G2 cables from connectors A1J4 and A1J5.
3. Remove nuts securing the A1G1 A1G2 controls to the board and remove controls.

A1KPD Keypad

1. Remove the A1 Front Panel Board as described in that procedure.
2. With board removed, keypad can easily be lifted out of the Front Panel Assembly.

Rear Panel and/or A2 GPIB or Isolator Board

To remove these two assemblies together, proceed as follows:

1. Disconnect the cables from the following connectors on the A2 board:
 - a. Ac bias cable W6 from P101 (or J803 on 657xA).
 - b. Phone cable W4 from J107 (or J800 on 657xA).
 - c. Phone cable W5 from J108 (or J801 on 657xA).
2. Remove the AC input safety cover (2 screws) and line cord connections on rear panel.
3. Remove the DC output safety cover (4 screws) and the \pm Output and \pm LS sense connections on the rear panel.
4. Remove the "quick disconnect" plug (if present) from the analog connector (near **OUT** terminal) on rear panel.
5. Remove two screws securing the plastic output name plate to the \pm bus bars.
6. Remove two screws securing the heatsink assembly brackets to rear panel.
7. Remove the nut securing the ground wire to the Output Signal ground terminal on the rear panel.
8. Remove two screws (one on each side) securing the rear panel to the chassis and remove the Rear Panel/A2 board.

To remove only the A2 board, proceed as follows:

1. Disconnect cables from the A2 board as described in Step 1.
2. Remove two screws securing A2 board to rear panel.
3. (667xA Only) Remove the two hex standoffs and washers securing the GPIB connector to the rear panel.
4. (667xA Only) Release GPIB board from holding bracket and remove board from the chassis.

Output Subchassis

The Output Subchassis houses the A5 Control Board, A6 Output Board, A7 Snubber Board, power output transformer, choke and output heatsink assembly. The output power rectifier (D900) and the downprogrammer FETS (A6Q901/902) are mounted on the output heatsink assembly. To remove the Output Subchassis, proceed as follows:

1. Remove Top Cover and RFI Shield as described under their respective procedures.
2. Remove the Rear Panel and A2 Board as described in the combined procedure.
3. Disconnect the two transformer T900 primary leads from the TB201 terminals (fuse clip type) on the A3 FET Board.
4. Disconnect cables from the following connectors on the A5 Control Board:
 - a. Phone cable W4 from A5J502
 - b. Ribbon cable W3 from A5J509
 - c. 2-wire cable W7 from A5J503 (position the cable away from and clear of output heatsink assembly)
5. Remove screw securing output heatsink bracket to the fan assembly.
6. Remove the screw (located between T900 and L200) securing the bottom of the Output Subchassis to the main chassis.
7. Remove three screws securing the side of the Output Subchassis to the side of the main chassis.
8. Slide Output Subchassis to rear, lift it up, and remove it from the main chassis.

A5 Control Board

Note The A5 Control Board can be removed from the power supply without first removing the Output Subchassis as previously described.

If the output subchassis has not been removed, disconnect cables from the A5 board as described in Step 4 of the "Output Subchassis" and then remove the A5 board as follows:

1. Remove two screws securing the board to the Output Subchassis.
2. Slide the A5 board upward and free of the two standoff mounts and the plug-in connection A5J510/A6J900 with the A6 Output Board.
3. Remove board from the output subchassis.

A6 Output Filter Board

1. Remove the A5 Control Board as described in that procedure.
2. On the Output Filter Board, remove the nut securing the lead from choke L900.
3. Remove the bolt that secures the Output Filter Board + OUT out bus bar to the heat sink.
4. Remove the screws that secure the Output Filter Board downprogrammer MOSFETs (Q901/Q902) to the heat sink. (Use size T-10 TORX screwdriver.)

Note Apply a thermal compound before you reconnect Q901/Q902 to the heat sink.

5. Remove three screws that secure the Output Filter Board to the Output Subchassis.
6. Slide the Output Filter Board forward to release it from stand offs (5) and lift the board out of the subchassis.

A7 Snubber Board and D900 Output Rectifier

1. Remove two bolts securing the leads from the Snubber Board and transformer T900 to output rectifiers D900, mounted on the heat sink assembly.
2. Remove screw securing the Snubber Board to the heat sink and remove the board.
3. Remove two bolts securing D900 to the heat sink and remove D900.

Note When replacing D900, follow the procedure given in Figure 3-19.

T900 Output Power Transformer/L900 Output Choke

1. Remove the bolt and nut that connect transformer T900 and choke L900 leads together (two from T900 and one from L900). (The bolt is accessible through a hole in the Output Subchassis).
2. Remove T900 or L900 by removing the four screws that secure each component to the Output Subchassis.

AC Input Filter

1. Remove the Top Cover and the RFI Shield as described in their respective procedures.
2. Remove the A2 board as described under, "Rear Panel and/or A2 GPIB or Isolator Board" earlier.
3. Disconnect the ac line and neutral output lines going to the A4 AC Input Board (load) side of the filter.
4. Remove four screws securing the Input Filter to the chassis and lift the filter out of chassis. (When you replace the filter, connect the "load" side to the AC Input Board.

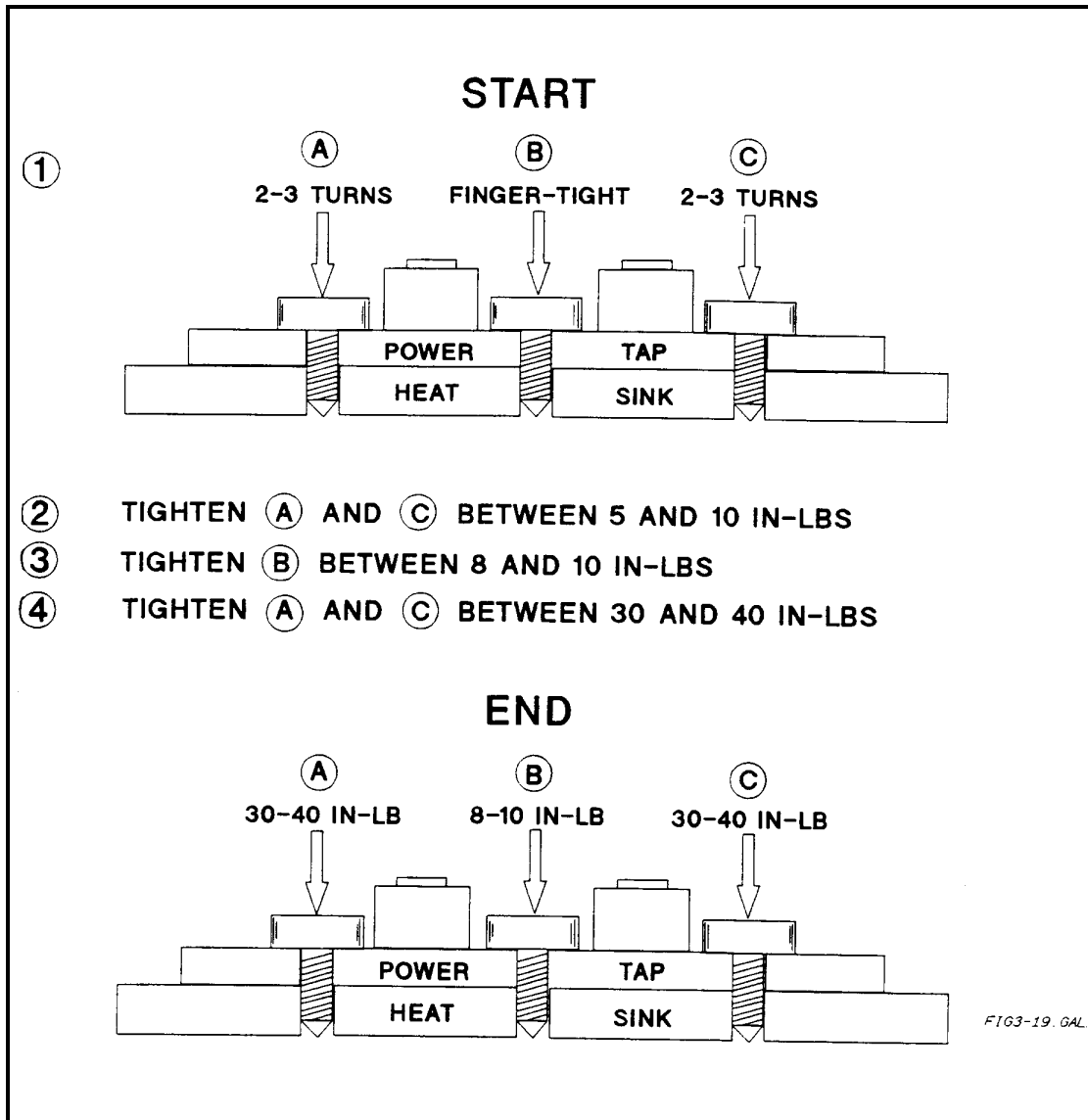

Figure 3-19. Proper Mounting Procedure for Output Rectifiers D900

A3 FET Board and Heatsink Assembly

1. Disconnect cables/wires from the following points:
 - a. + 15V_p bias cable W8 from A4J400 on the AC Input Board.
 - b. + (red) and -(black) rail cable W9 leads from E411 and E412 on the AC Input Board;
 - c. 2-wire cable W7 from A3J200 on the FET Board.
2. Remove screw securing the FET heatsink to the fan assembly.
3. Remove screw securing the FET heatsink to the bottom of the main chassis.
4. Slide the FET Board/Heatsink Assembly forward and lift it out of chassis.
5. Pry up the plastic tabs securing the FET Board and the Heatsink Assembly to the metal bracket and separate the heatsink from the bracket.

To further separate the A3 FET Board from the Heatsink Assembly, proceed as follows:

CAUTION

Observe standard antistatic practices against ESD when working with the MOSFETs. Refer to Chapter 1 for more information on antistatic procedures.

1. Remove four screws securing the FET Board to the Heat Sink Assembly.
 2. Remove the two screws securing each of the eight MOSFET's to the Heatsink Assembly and the sockets on the FET Board. (Use a size T-10 TORX screwdriver to remove these screws.)
 3. Unplug each MOSFET from the socket on the FET Board and separate the board from the Heat Sink Assembly.
-

Note

When you replace these MOSFETs (Q201-204, 211, 222, 233, 244), be sure to install the appropriate mica insulator (see "Replaceable Parts") between each MOSFET and the heat sink.

A4 AC Input Board

1. Remove the A3 FET Board and Heatsink Subassembly as described in the combined procedure.
 2. Disconnect the cable from A4J302.
 3. Remove the 13 screws securing the AC Input Board to the chassis.
 - 4.
-

Note

8 of these screws also fasten L400 and T300 to the board via standoffs between the board and the chassis.

5. Slide board forward and remove it from chassis.

B1 Fan

1. Remove the fan cable from A4J302.
2. Remove the two screws securing the heatsink brackets to the fan bracket.
3. Remove the two screws securing the fan bracket to the bottom of the chassis.
4. Remove fan assembly (fan and bracket) from supply.
5. Remove the screws, washers, nuts securing the fan to the bracket and separate the two. (Use size T-10 TORX screwdriver.)

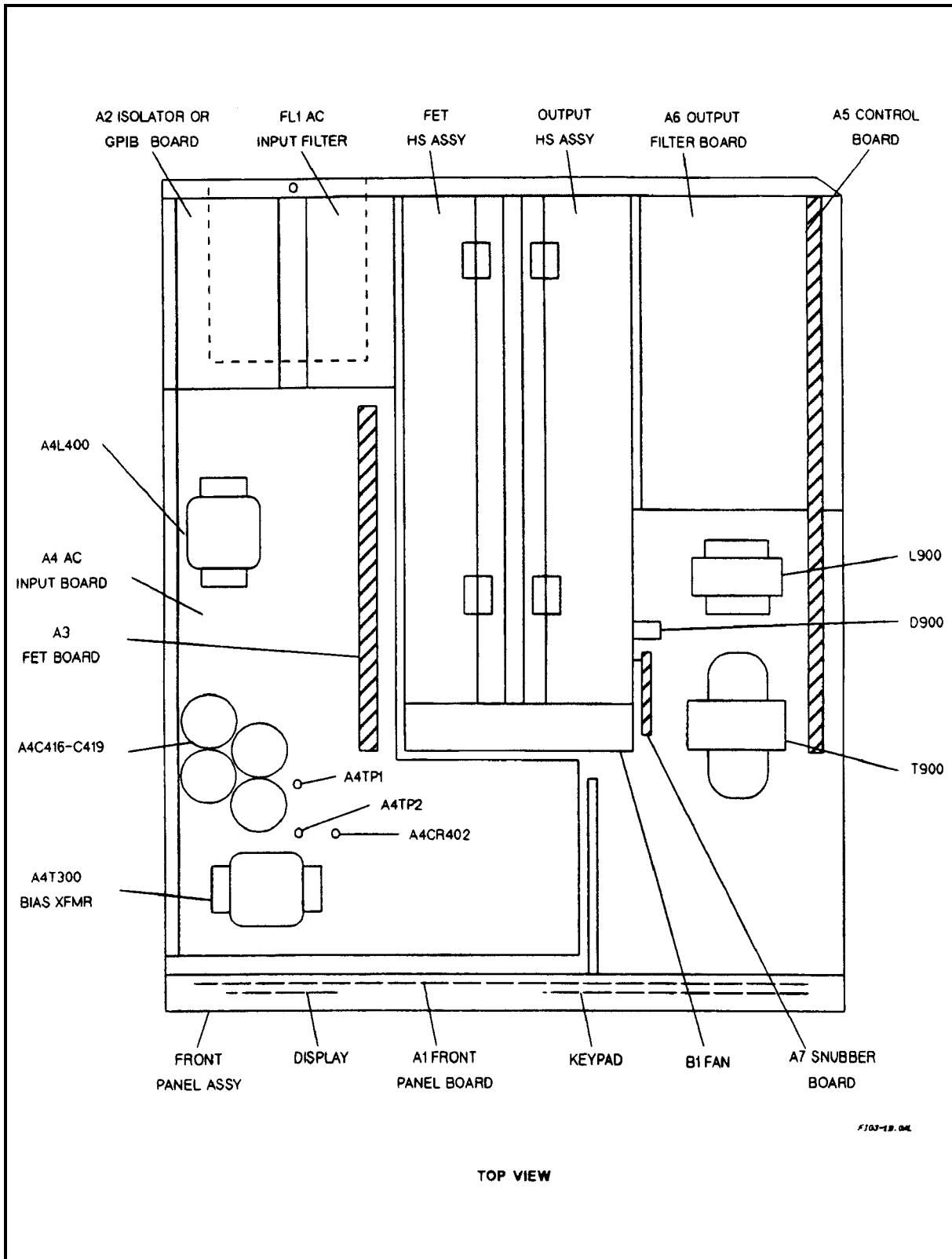

Figure 3-20. Component Locations (Top Cover and RFI Shield Removed)

Principles of Operation

Introduction

Figure 4-1 (at the end of this chapter) is a block diagram showing the major circuits within the power supply. The supply's interface and control circuits consist of circuits on the A1 Front Panel Board, A2 GPIB or Isolator Board, and A5 Control Board. The power circuits are the A4 AC Input Board, A3 FET Board, A7 Snubber Board, A6 Output Filter Board, and a few components mounted on the chassis.

Each block in Figure 4-1 identifies a schematic diagram in Chapter 6 where the circuits are shown in detail. You can refer to the schematic to locate specific components mentioned in this description. Chapter 6 also has a cabling diagram (Figure 6-2) showing the circuit board interconnections.

INTERFACE CONTROL CIRCUITS

A2 GPIB Board (667xA Series Only)

Circuits on the A2 GPIB board (see A2 GPIB Board schematic) provide the interface between the GPIB controller and the power supply. All communications between the power supply and the GPIB controller are processed by the GPIB interface and primary microprocessor circuits on the A2 board. The primary microprocessor circuits (microprocessor U114, ROM U106, and RAM U108) ICs decode and execute all instructions and control all data transfers between the GPIB controller and the Secondary Interface on the A5 Control Board. The primary microprocessor also processes measurement and status data received from the Secondary Interface.

A UART (universal asynchronous receive/transmit) IC (U112) on the A2 board converts data between the primary microprocessor's 8-bit, parallel bus and the serial I/O port. The serial data is transferred between the primary interface and the secondary interface via a programmed GAL (gated array logic) IC (U119) and optical isolator ICs (U110/U111). These ICs isolate the primary interface circuits (referenced to earth ground) from the secondary interface circuits (referenced to power supply common). The GAL IC also provides a serial I/O port to the A1 Front Panel Board to enable front panel control of the power supply.

A serial link interface IC (U109) on the A2 GPIB Board allows up to sixteen supplies to be connected together and programmed from one GPIB address. The first supply is the only supply connected directly to the GPIB controller and is set to the primary GPIB address. The remaining supplies are set to secondary addresses and are linked (daisy chained) together via the J1/J2 phone jacks at the rear of each supply. The serial link configuration is described in the Power Supply Operating Manual.

A digital control interface on the A2 GPIB Board provides the following power supply functions:

- Relay link.
- Digital I/O.
- Remote inhibit (INH).
- Discrete fault indicator (FLT).

An optical isolator IC (U113) isolates the FLT output signal common from the external fault circuit common.

The desired digital interface function is selected by placing a jumper in a header (J106) on the A2 GPIB Board. Appendix D in the Power Supply Operating Manual describes how to select one of these functions and how to make the appropriate external connections to the DIG CNTL connector on the supply's rear panel. Another jumper position on the header selects the SA (signature analysis) mode, which is used for troubleshooting (see Chapter 3).

The A2 Board has a bias supply regulator IC (U121) that provides +5V (with respect to earth ground) for the primary interface circuits and the bias voltage for the front panel board circuits, the LCD, and the keypad. The A2 Board also has a line or bias voltage detector IC (U101) that generates a power clear signal (PCLR). This signal initializes certain primary interface and front panel circuits when normal ac line voltage is applied, and also shuts these circuits down when the line voltage drops below the required minimum.

A2 Isolator Board Circuits (657xA Series Only)

The isolator board performs the following two functions:

1. Creates a +5V bias voltage.
2. Provides isolation between the PCLR, RxD, and TxD front panel signals and similar signals received from the A1 Main Board.

When power is turned on to the power supply, an isolated AC signal from XFMR T1 in the secondary circuits is applied to a +5V bias supply (U805) on the isolator board. The bias supply produces a +5V BIAS output voltage that is routed to the front panel circuits.

At the same time, a low SPCLR* level from the secondary circuits is applied to optical isolator circuit U800. It is then routed as a low PCLR* level to the RESET* input of the front panel microprocessor. This low level keeps the microprocessor temporarily disabled during power turn on for a short time interval. After a delay of 40 ms, SPCLR* goes high and the microprocessor is enabled. By inhibiting microprocessor operation for 40 ms, any erroneous operation (due to a rising but yet unstable +5V) is prevented until the +5V BIAS voltage fully settles.

When power is turned off or is removed, SPCLR* goes low immediately to disable the microprocessor in order to provide a graceful shutdown of the power supply as the +5V falls to zero volts.

Note PCLR* is generated in the GPIB Board for Keysight 667xA models. For Keysight 657xA models, it originates at the main board secondary circuits and is routed to the Isolator Board.

The isolator board includes three separate optical isolator circuits that isolate the front panel signals: RxD, TxD, and PCLR* signals from the SRx, BSTx and SPCLR* signals at the secondary interface circuits.

A1 Front Panel Assembly

The power supply A1 Front Panel Assembly contains a circuit board, keypad, liquid crystal display (LCD), and the power on/off switch. Circuit details are shown on the A1 Front Panel Board schematic.

Front Panel Circuit Board A1 contains microprocessor circuits (microprocessor U3 and ROM U4) that decode and execute all front panel keypad commands. These are transferred to the power supply output via the serial I/O port to the A2 board GAL (gated-array logic) IC and isolators, and to the secondary interface circuits on the A5 Control Board. The front panel microprocessor circuits also process power supply measurement and status data received from the serial I/O port. This data is displayed on the LCD.

IC EEPROM (electrically erasable programmable read-only memory) (U6) on the A1 Front Panel Board stores data and configuration information. This information includes calibration constants, GPIB address (667xA Series only), the present programming language, and model-dependent data such as the minimum and maximum values of voltage and current. One of the EEPROM storage locations holds a checksum value used to verify the integrity of this EEPROM data. Access to the

calibration data in the EEPROM is controlled by the combination of a password and jumper options on a header (J3) located on the A1 board (see "Post-Repair Calibration" in Chapter 3).

The power supply can be calibrated with front panel keys or over the GPIB (667xA Series) with SCPI (Standard Commands for Programmable Instruments) commands. The calibration procedure is in Appendix A of the Power Supply Operating Manual).

A5 Control Board

The A5 Control Board contains the Secondary Interface, the CV/CC (constant voltage/constant current) Control Circuits, and the Switching/Downprogramming Control circuits. These circuits are shown schematically on Sheets 1 through 3 of the A5 Control Board schematic.

Secondary Interface

These circuits are shown in detail in the A5 Control Board schematic, Sheet 1, and include the Secondary Microprocessor IC (U504), the Programmed GAL IC (U502), three DAC/OP amp (digital-to-analog converter/ operational amplifier) circuits (U507-U512), and Readback Comparator circuits (U503 and U513). The secondary microprocessor translates the serial data received from the A2 board into a parallel 12-bit data bus. The data bus is connected directly to the three DAC/OP amplifier circuits. Under control of the microprocessor, the selected DAC converts the data on the bus into an analog signal. The DAC reference circuit (U505, U517) provides a +10V reference for the CV and CC DACs and a -11.6V reference for the readback DAC.

A CV DAC/OP amplifier (U507, U508) converts the programmed value of voltage on the bus into the **CVPROG** signal. **CVPROG** is sent to the CV control circuits to control the magnitude of the output voltage in the CV mode. The range of **CVPROG** is 0 to -10V, which corresponds to the zero-to-full scale output voltage range of the power supply.

A CC DAC/OP amplifier (U509, U510) converts the programmed value of current on the bus into the **CCPROG** signal. **CCPROG** is sent to the CC control circuits to control the magnitude of the output current in the CC mode. The range of **CCPROG** is 0 to -10V, which corresponds to the zero-to-full scale output current range of the supply.

The Readback Comparator circuits (U503, U513) operate with the readback DAC/OP Amplifier (U511, U512) to return the following signals to the microprocessor:

- The monitored output voltage (**VMON**).
- The monitored output current (**IMON**).
- The ambient temperature (**AMB_SENSE**).
- The programmed voltage value (**CVPROG**).
- The programmed current value (**CCPROG**).
- The fan speed (**FAN_SENSE**).

The readback DAC circuit is controlled by the microprocessor to successively approximate (to 12-bit resolution) the value of each signal monitored. The **CVPROG** and **CCPROG** signals are used during self test to check operation of the DAC/OP amplifier circuits. The microprocessor monitors the fan speed (**FAN_SENSE**) and the supply's ambient temperature (**AMB_SENSE**) in order to generate a **FAN_PWM** control signal. The pulse width of **FAN_PWM** is varied according to the ambient temperature. The signal is applied to the fan speed control circuit on the A4 AC Input Board to increase the fan speed as temperature increases and decrease the fan speed as temperature decreases.

The Secondary Microprocessor generates **OVPROG**, a pulse-width modulated signal that represents the programmed overvoltage protection level. **OVPROG** is processed by Programmed GAL U502 and U517 to produce **OVREF**, which is sent to an OV Comparator circuit (U630 in A5 Control Board schematic, Sheet 3). This circuit compares the actual output voltage level with **OVREF**. When the output voltage exceeds **OVREF**, the OV comparator circuit produces a low-level **OVCMP** signal, which is applied to the Programmed GAL (A5 Control Board schematic, Sheet 1). When **OVCMP** goes true, the GAL circuit produces a high-level **OVSCR** signal that causes the following actions to occur:

- The supply's output is downprogrammed.
- The pulse width modulator (described later) is disabled.
- With the pulse width modulator disabled, the drive signals for the FET regulators are removed, thereby turning off the power supply output.
- When OV is reset, the secondary microprocessor generates **OVCLR** (output protection clear), which clears **OVSCR**.

During power initiation, the secondary microprocessor generates an **INHIBIT** signal to hold the supply's output off for ten seconds. After 10 seconds **INHIBIT** is removed and the output can be programmed.

CV/CC Control

These circuits are shown in detail on the A5 Control Board schematic, Sheet 3 and include CV (constant-voltage) and CC (constant-current) control loops. The power supply must act as either a CV or CC supply for any value of load impedance. Switching between CV and CC mode is done automatically by the CV/CC control circuits at a value of load impedance equal to the ratio of the programmed voltage value to the programmed current value. A low-level **CV** or **CC** signal is generated by the applicable Status Comparator (U630) and returned to the secondary interface to indicate that the corresponding mode (CV or CC) is in effect.

In CV mode, an OR gate diode (D620) conducts and the CV loop regulates the output voltage. A CV Error Amplifier (P/O U615) compares the programmed voltage signal **CVPROG** (0 to -10V range) to **VMON**, which is the output voltage monitor output signal of V_DIF Differential Amplifier (P/O U615). The range of **VMON** is 0 to +10V, which corresponds to the zero-to-full scale output voltage of the supply. If the output voltage exceeds the programmed voltage, the **OR_GATE** signal goes low, causing the output voltage to decrease to the programmed value. Conversely, if the output voltage is less than the programmed voltage, **OR_GATE** goes high to cause the output voltage to increase to the programmed value. An externally applied dc signal (**VPROG**) can also be used to program the output voltage. A 0 to -5V **VPROG** level produces a proportional zero-to-full scale output voltage.

In CC mode, an OR gate diode (D615) conducts and the CC loop regulates the output current. A CC Error Amplifier (P/O U612) compares the programmed current signal **CCPROG** (0 to -10V range) to **IMON**, which is the output current monitor signal. This signal is produced by measuring the voltage across a current monitor resistor (A6R907) on the A6 Output Filter Board.

The voltage drop across A6R907 (\pm ISEN) is amplified by 1st I_AMP (U617) and 2nd I_AMP (U612) to produce current monitoring signal **IMON**. The range of **IMON** is 0 to +10V, which corresponds to the zero-to-full scale output current of the supply. If the output current exceeds the programmed current, the **OR_GATE** gate signal goes low, causing the output current to decrease to the programmed value.

Conversely, if the output current is less than the programmed value, the **OR_GATE** signal goes high, causing the output current to increase to the programmed value. An externally applied differential voltage signal (\pm IP) can also be used to program the output current. The **IP** signal is applied to the CC Error Amplifier via the IPROG Amplifier (P/O U618). A 0 to 10V differential input level produces a proportional zero-to-full scale output current.

Switching/Downprogramming Control

These circuits (A5 Control Board schematic, Sheet 3) include a Ramp Generator, Fast-Sense Differential Amplifier, Summing Amplifier, Divider, Pulse-Width Modulator, Downprogramming Control, and Overvoltage Comparator circuits.

The **OR-GATE** signal (**CV** or **CC** control signal as previously described) is summed with a fixed 40-KHz triangular waveform produced by the Ramp Generator. An input from the Fast Sense Differential Amplifier also is summed in order to compensate for sudden transients in the rectified output.

The Ramp Generator derives its output signal from 40KHz pulses received from the Divider circuit. The Divider circuit also generates output pulses for a Deadtime Latch and an On Latch. The Divider clock input is the 2MHz **ALE_CK** signal from

the secondary microprocessor. The width of the output pulses from the Summing Amplifier vary as the **OR_GATE** control signal decreases or increases. These pulses are applied to the Pulse-Width Modulator IC via the On Latch. The Pulse-Width Modulator generates the square-wave pulses that are applied to the A3 FET Board to turn the FET switches on and off. The Deadtime Latch resets the On Latch to provide a minimum dead (off) time for the FET switches .

The OV circuit compares the output voltage level with a signal (**OVREF**) that represents the programmed overvoltage level. When the output voltage exceeds the programmed value, the downprogramming circuits are activated and the FET switches are turned off.

The downprogramming control circuit generates control signal **DP** when an OV or **INHIBIT** condition has been detected, or when the output is higher than was programmed. DP causes the downprogramming MOSFETS on the A6 Output Filter Board to conduct current away from the load.

Power Circuits

A4 AC Input Board

The A4 AC Input Board (see A4 AC Input Board schematic) includes the following circuits:

Input Filter and Rectifier

The single-phase ac input (220/240 vac) is applied through chassis-mounted line filter FL1, a 25-ampere line fuse (A4F400) and filter components on the A4 board to the front panel switch (S1). When the switch is turned on, filtered ac input is applied to a bias transformer (A4T300) via a line voltage select switch (A4SW300) and through turn-on relay (A4K401) contacts and R400/R401 to a bridge rectifier (A4D400).

The ac line voltage is rectified and filtered to provide the \pm RAIL (290 volts) input lines to the A3 FET Board. Because filter capacitors are connected directly across the rectified line (\pm RAILS), large inrush current surges at turn-on could blow fuses or affect the operation of other equipment connected to the same ac line. This is prevented by the time-delay action of one of the turn-on relays (AK400). During the turn-on period (approximately 10 seconds), relay A4K400 is deenergized and presents a higher input resistance that limits inrush current. After the turn-on period, relay A4K400 energizes and decreases R400/R401 input resistance.

Bias Supplies and Bias Detect

The secondary windings of the bias transformer (A4T300) provide ac inputs to the +15V_p primary bias supply (components D313-D316, U302), the \pm 15V_s secondary bias supply (components D306-D309, U305, U306) and the fan voltage supply (components D310, D317). In addition, the bias transformer applies ac power to the +5V_p Primary Interface Bias Supply on the A2 GPIB or Isolator Board.

The +15V_p bias voltage is used to operate the turn-on relays (K400/K401), an Isolation Optoisolator (U309), and by circuits on the A3 FET Board. The \pm 15V_s bias voltage is used by the fan speed control circuits and also powers the +5V_s and \pm 14V bias voltages used by circuits on the A5 Control Board.

The purpose of the Bias Detect Circuit (U308) is to disable the power supply output until the bias voltages have stabilized. When power is initially applied, the circuit generates a **RESET** signal to disable the supply's output and to initialize the secondary interface microprocessor on the A5 Control Board. When the bias circuit has stabilized, the Bias Detect Circuit detects a BIAS_OK signal from the A5 Control Board and removes the **RESET** signal to enable the power supply output.

Fan Speed Control

A fan speed control circuit (U304, U311) provides the dc voltage to operate the cooling fan. A pulse-width modulated signal (**FAN_PWM**) from the secondary microprocessor on the A5 Control Board varies this voltage to increase or decrease the fan speed according to the ambient temperature. The secondary microprocessor determines the level of **FAN_PWM** by monitoring a fan speed signal (**FAN_DETECT**) and the ambient temperature, as measured by the voltage drop across a thermistor (A4RT300). Chassis-mounted fan BI is shown on A4 AC Input Board schematic.

A3 FET Board

The A3 FET Board has 8 power FET stages and 2 bridge driver IC's (see A3 FET Board schematic). The power FETs are mounted on, but are electrically isolated from, a heat sink assembly. The FET stages are connected from the +RAIL and the -RAIL to the power transformer (T900) in an H-bridge configuration.

DRIVE_A and **DRIVE_B** pulses, received from the A5 Control Board, are used by the bridge driver ICs (U201 and U202) to derive control pulses (**DRIVE1** and **DRIVE2**) for the FET switches. The width of these pulses determines the ON time of the FET switches, thereby determining the magnitude of the output voltage or current. **DRIVE1** pulses turn on one set of +RAIL (Q201, Q211) and -Rail (Q203, Q233) FETS, causing current to flow through power transformer T900 in one direction. **DRIVE2** pulses turn on the other set of +RAIL (Q204, Q244) and -Rail (Q202, Q222) FETS, causing current to flow through T900 in the opposite direction. The FET on/off periods are controlled by Duty Cycle Detect and the peak current detection circuits. If the output attempts to change, regulation is accomplished by the CV/CC Control Circuits on the A5 Control Board (previously described). These circuits vary the width of the drive pulses and the duration of the FET on/off periods.

Output Circuits

The output circuits consist of chassis mounted components (power transformer T900, power rectifier D900, and inductor L900), the A6 Output Filter Board, and the A7 Snubber Circuit Board. These circuits are shown on the corresponding model schematic (see Chapter 6). Power transformer T900 couples the output pulses from the A3 FET Board to the power full-wave rectifier D900. Filtering is provided by L900 and the A7 Snubber Board. The A6 Output Board provides both normal-mode and common-mode filtering as well as downprogramming circuits. When activated, the downprogramming circuits draw current from the output terminals.

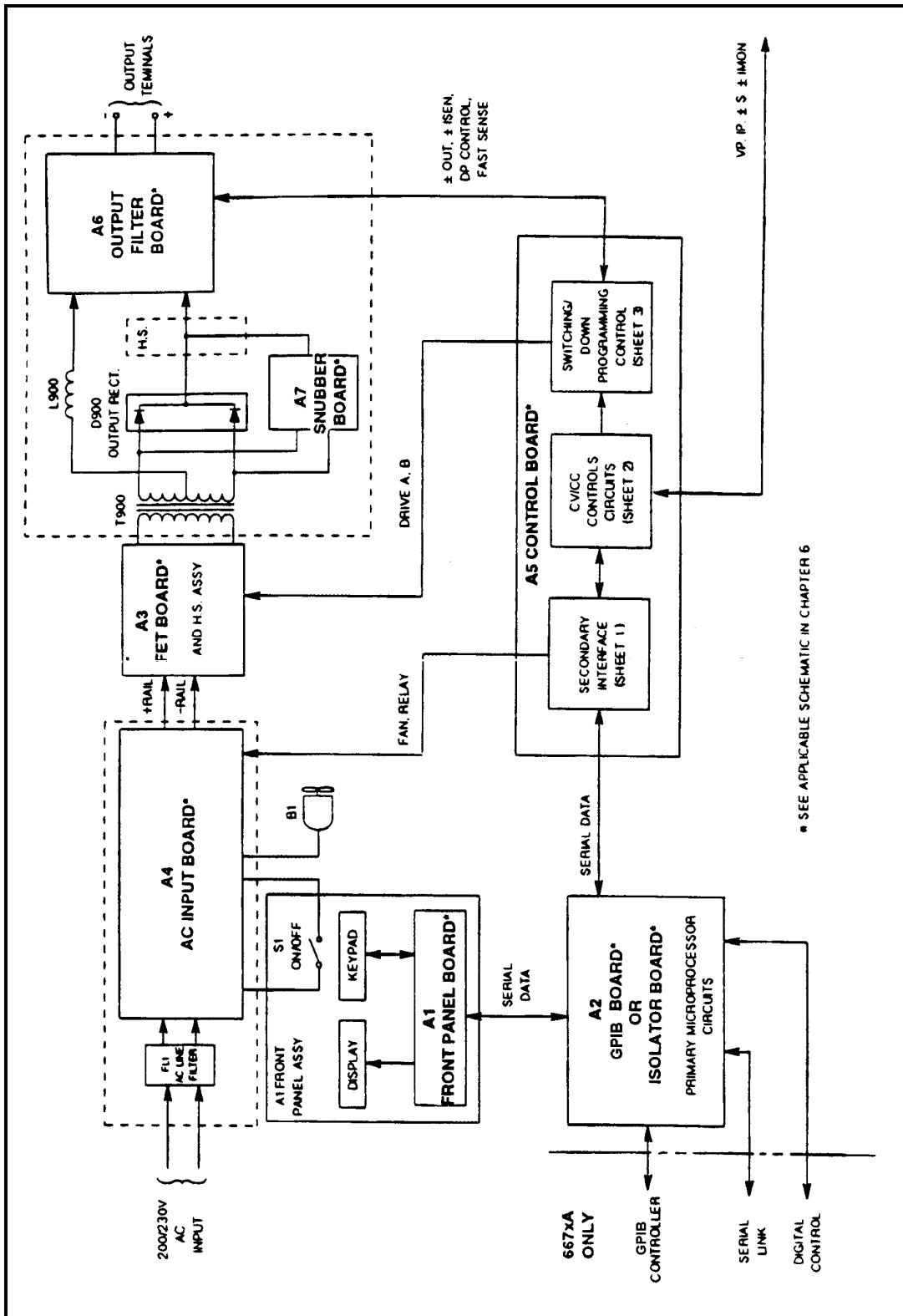

Figure 4-1. Keysight Series 665xA/667xA Power Supply, Block Diagram

Replaceable Parts

INTRODUCTION

Chapter Organization

This section lists the replaceable electrical and mechanical parts for the Keysight 657xA and Keysight 667xA Series power supplies. (Component location diagrams are located in Chapter 6.) The lists consist of tables organized by assemblies as follows:

Assembly	See
Main chassis *	Table 5-3
A1 Front Panel Board (used in all models)	Table 5-4
A2 Isolator Board (used in Keysight 657xA models)	Table 5-5
A2 GPIB Board (used in Keysight 667xA models)	Table 5-6
A3 FET Board (used in all models)	Table 5-7
A4 AC Input Board (used in all models)	Table 5-8
A5 Control Board (model-specific assembly)	Table 5-9
A6 Output Filter (model-specific assembly)	Table 5-10
A7 Snubber Board (model-specific assembly)	Table 5-11
* The locations of circuit board assemblies and chassis-mounted components are shown in Figure 3-20.	

Reading the Tables

Each table lists electrical components alphabetically by reference designator and provides the Keysight part number followed by the part description. Mechanical parts are placed after the electrical parts and listed alphabetically by part description. Unless otherwise specified, a listed part is used in all models of the series. Model-specific parts are tabulated by model number under the reference designator. The reference designators are defined in Table 5-1. Abbreviations used in parts descriptions are explained in Table 5-2.

Table 5-1. Part Reference Designators

A	assembly
B	blower (fan)
C	capacitor
CR	thyristor/SCR
D	diode
DSP	display (LCD)
F	fuse

J	jack
K	relay
L	inductor
P	plug
Q	transistor
R	resistor
RT	thermal resistor

SW	switch
T	transformer
TB	terminal block
U	integrated circuit
VR	voltage regulator
W	cable or jumper
Y	crystal oscillator

Table 5-2. Part Description Abbreviations

assy	assembly	M	metric	sq	square	w/o	without
bd	board	mch	machine	submin	subminiature	xfmr	transformer
blvl	belleville	mm	millimeter	thk	thick	xtal	crystal
gnd	ground	mtg	mounting	thrd	thread		
lg	long	PCB	pc board	w/	with		

How To Order Parts

You can order parts from your local Keysight Technologies Sales and Support Office (see the list of offices in the back of this manual). When ordering a part, please include the following information:

- the Keysight part number
- the part description
- the desired quantity
- the model number of the power supply (for example, Keysight 6682A)

Table 5-3. Main Chassis, Replaceable Parts

Ref. Desig.	Keysight Part No.	Description
ELECTRICAL PARTS		
A1	5060-3400	Front Panel Board, for all 667xA Models (see Table 5-4)
A1	--	Front Panel Board Tested & Initialized (see Table 5-4)
6571A	06571-61001	
6572A	06572-61001	
6573A	06573-61001	
6574A	06574-61001	
6575A	06575-61001	
A2	5060-3398	Isolator Board (see Table 5-5)
A2	5060-3592	GPIB Board (see Table 5-6)
A3	5060-3338	FET Board Heat Sink Assembly (see Table 5-7)
A4	5060-3341	AC Input Board (see Table 5-8)
A5	--	Control Board (see Table 5-9)
6571A, 6671A	06671-61020	
6572A, 6672A	06672-61020	
6573A, 6673A	06673-61020	
6574A, 6674A	06674-61020	
6575A, 6675A	06675-61020	
A6	--	Output Filter Board (see Table 5-10)
6571A, 6671A	06671-61024	
6572A, 6672A	06672-61024	
6573A, 6673A	06673-61024	
6574A, 6674A	06674-61024	
6575A, 6675A	06675-61024	
A7	--	Snubber Board (see Table 5-11)
6571A, 6671A	06671-61021	
6572A, 6672A	06672-61021	
6573A, 6673A	06673-61021	
6574A, 6674A	06674-61021	
6575A, 6675A	06675-61021	
B1	5060-3436	Fan assembly
C416-419	0180-4369	Capacitor 1500 μ F 400V
D900	--	Diode rectifier
6571A, 6671A	1906-0396	
6572A, 6672A	1906-0397	
6573A, 6673A	1906-0398	
6574A, 6674A	1906-0398	
6575A, 6675A	1906-0404	
FL1	9135-0439	Filter RFI
J900	1251-8667	Connector post test point
L900		Choke output (<i>Model specific</i>)
6571A, 6671A	06671-80003	
6572A, 6672A	06672-80003	
6573A, 6673A	06673-80003	
6574A, 6674A	06674-80002	
6575A, 6675A	06675-80003	

Table 5-3. Main Chassis, Replaceable Parts (continued)

Ref. Desig.	Keysight Part No.	Description
ELECTRICAL PARTS (continued)		
T900	--	Transformer power output (<i>Model specific</i>)
6571A, 6671A	9100-4909	
6572A 6672A	9100-4946	
6573A, 6673A	9100-4945	
6574A 6674A	9100-4910	
6575A, 6675A	9100-4944	
CABLES (see Figure 6-2)		
W1	5080-2172	Cable assy 4-wire (AIS1 to A4 AC Input bd)
W2	8120-4944	Cable ribbon (front panel display AIDSP1)
W3	5080-2166	Cable ribbon (A4 AC Input bd to A5 Control bd)
W4	5080-2167	Cable phone (A2 GPIB bd to A5 Control bd)
W5	5080-2168	Cable phone (A2 GPIB bd to A1 Front Panel bd)
W6	5080-2169	Cable assy 2-wire (A2 GPIB bd to A4 AC Input bd)
W7	5080-2170	Cable assy 2-wire (A3 FET bd to A5 Control bd)
W8	5080-2171	Cable assy 2-wire (A3 FET bd to A4J400 on A4 AC Input bd)
W9	5080-2178	Cable assy 2-wire (A3 FET bd to ± rails on A4 AC Input bd)
CHASSIS MECHANICAL		
G1,G2	0960-0912	Optical Encoders (Voltage and Current Controls)
DSP1	5063-2304	LCD Display
Keypad	5040- 1665	Keypad
S1	3101-3088	AC ON/OFF line switch
--	5040-1675	Bezel output
--	1510-0107	Binding post (rear panel gnd post)
--	5001-6740	Bracket GPIB
--	5040-1673	Bracket polycarb
--	5001-6766	Bracket A7 Snubber bd
--	5000-6554	Bracket strap
--	5041-8801	Bumper foot
--	--	Bus bar heat sink (<i>Model specific</i>)
6571A, 6671A	06671-00007	
6572A, 6672A	06671-00007	
6573A-6575A	5001-6749	
6673A-6675A	5001-6749	
--	--	Bus bar, minus (<i>Model specific</i>)
6571A, 6671A	06671-00008	
6572A, 6672A	06671-00008	
6573A, 6673A	5001-6750	
6574A, 6674A	5001-6750	
6575A, 6675A	5001-6750	

Table 5-3. Main Chassis, Replaceable Parts (continued)

Ref. Desig.	Keysight Part No.	Description
MECHANICAL PARTS (continued)		
--	--	Bus bar, plus (<i>Model specific</i>)
6571A 6671A	06671-00009	
6572A 6672A	06671-00009	
6573A, 6673A	5001-6751	
6574A, 6674A	5001-6751	
6575A, 6675A	5001-6751	
--	5041-8819	Cap strap handle
--	5041-8820	Cap strap handle
--	5060-3334	Chassis assy
--	1400-0611	Clamp cable (phone cable)
--	1531-0309	Clevis (A2 GPIB bd)
--	9170-1138	Core mtg assy
--	5001-6745	Cover
--	5001-6758	Fan bracket
--	5001-6747	FET chassis
--	5020-2741	FET heat sink
--	5001-6748	Front panel
--	5040-1664	Front panel frame
--	5020-2740	Heatsink diode
--	0340-0458	Insulator mica (FETs to heat sink)
--	0370-3238	Knob (front panel RPG control)
6571A	06571-80001	Nameplate
6572A	06572-80001	Nameplate
6573A	06573-80001	Nameplate
6574A	06574-80001	Nameplate
6575A	06575-80001	Nameplate
6671A	06671-80001	Nameplate
6672A	06672-80001	Nameplate
6673A	06673-80001	Nameplate
6674A	06674-80001	Nameplate
6675A	06675-80001	Nameplate
--	0590-0534	Nut self-threading (display to front panel)
--	0535-0002	Nut hex (shunt to PCB)
--	0535-0031	Nut hex w/lockwasher (bus bar to A6 output bd)
--	0590-0305	Nut hex w/lockwasher (L901,902 brkt)
--	0535-0031	Nut hex w/lockwasher M3X.5 2.4 mm(fan to bracket)
--	0590-0305	Nut hex w/lockwasher 6-32 thrd .094 in thk (ground wire to rear panel)
--	2550-0084	Nut hex (bus bar)
--	2950-0144	Nut hex (rear panel gnd post)
--	0905-0193	O-ring 1.12in (input caps)
--	5001-6746	output chassis (sense term)
--	5080-2184	Rear label
--	5001-6743	Rear panel
--	5040-1674	Safety cover dc output
--	5040-1676	Safety cover ac input

Table 5-3. Main Chassis, Replaceable Parts (continued)

Ref. Desig.	Keysight Part No.	Description
MECHANICAL PARTS (continued)		
--	2680-0215	Screw mch 10-32 (output caps)
--	2940-0103	Screw cap 1/4-20 (power xfmr to diode block bus to heat sink)
--	0515-1253	Screw cap M8x1.25 30 mm lg (shunt to PCB)
--	2940-0103	Screw cap 1/4-20 (diode block to heat sink)
--	2940-0103	Screw cap 1/4 x 20 (bus bar)
--	2680-0222	Screw mch 10-32 (caps ac input)
--	0515-0104	Screw mch M3x0.5 8 mm lg (sense term)
--	0515-0374	Screw mch M3x0.5 10 mm lg (front frame, Q901 to heat sink)(5)
--	0515-0433	Screw mch M4x0.7 8 mm lg Qty 2 (for Isolator to chassis mtg)
--	0380-1524	Standoff Qty 2 (for Isolator to chassis mtg)
--	3050-0893	Flatwasher Qty 2 (for Isolator to chassis mtg)
--	2190-0586	Split washer Qty 2 (for Isolator to chassis mtg)
--	0535-0024	Nut Qty 2 (for Isolator to chassis mtg)
--	5001-6775	Cover (for Isolator to chassis mtg)
--	0515-0375	Screw mch M3x0.5 16m lg (fan)
--	0515-0382	Screw mch M4x0.7 12 mm lg (line choke, busbar to support, output choke, output xfmr, diode block)
--	0515-0433	Screw mch M4x0.7 8 mm lg (cap, RFI fan brkt, GPIB, cover, A6 output Filter bd gnd, A5 Control bd to subchassy, diode block and A7 Snubber bd to heat sink)
--	0515-0906	Screw mch M4x0.7 50 mm long (bias xfmr)
--	0515-1132	Screw mch M5x0.8 10 mm long (strap handles)
--	0515-0375	Screw mch M3x0.5 10 mm long (FETs to sockets)
--	0515-0433	Screw mch M4x0.7 8 mm long (FET bd mtg)
--	5001-6763	Shield RFI
--	5001-0539	Side trim strips
--	0380-0643	Standoff hex 0.255 in (GPIB connector)
--	0380-1524	Standoff hex 8 mm (control bd mtg)
--	7144-0535	Standoff slide (mtg A5 Control bd to chassis)
--	0380-1524	Standoff hex 8 mm (FET bd mtg)
--	5062-3705	Strap handle
--	0362-0681	Terminal crimp AC power cord
--	0362-0207	Terminal crimp AC power cord gnd
--	1205-0777	Thermal pad
--	3050-0629	Washer flat (diode block to heat sink)
--	3050-1690	Washer spring (diode block to heat sink)
--	3050-0002	Washer flat (caps to bus bars)
--	3050-0629	Washer flat (choke to bus bar)
--	3050-0858	Washer spring blvl (current shunt to A6 output bd)
--	3050-0893	Washer flat (A6 output and A5 Control bd to subchassis)
--	3050-0993	Washer flat (current shunt to A6 output bd)
--	3050-1677	Washer (choke)

Table 5-3. Main Chassis, Replaceable Parts (continued)

Ref. Desig.	Keysight Part No.	Description
MECHANICAL PARTS (continued)		
--	3050-1690	Washer spring (choke to bus bar, choke to xfmr, bus to heat sink, transformer to diode block)
--	2190-0034	Washer lock hlcl (caps ac input)
--	2190-0586	Washer lock hlcl (GPIB connector)
--	3050-0002	Washer flat (caps ac input)
--	3050-1690	Washer spring (bus bar)
--	2190-0586	Washer lockwasher hlcl (A3 FET bd mtg)
--	3050-0893	Washer flat (A3 FET bd mtg)
--	1000-0842	Window (front panel display)
MISCELLANEOUS		
	5080-2148	Chaining cable for power supply link
	1252-1488	Quick-disconnect mating plug for DIG CNTL connector on rear panel
	1252-3698	Quick-disconnect mating plug for analog connector on rear panel
		Quick-Start Guide, European (see 5959-3372)
	5959-3372	Manual, Series 667xA operating
	5959-3398	Manual, Series 667xA operating
	8120-5488	Option 831 12 AWG power cord w/o plug
	8120-5490	Option 832 4 sq mm power cord w/o plug
	8120-5545	Option 834 10 AWG cord w/o plug
	8120-5491	Option 841 12 AWG cord with plug (NEMA 6-20P)
	8120-5489	Option 842 4 sq mm power cord with plug (IEC 309-32A)
	8120-5487	Option 843 12 AWG power cord with plug (JIS C8303)
	8120-5546	Option 844 10 AWG power cord with plug (NEMA L6-30P)

Table 5-4. A1 Front Panel Board, Replaceable Parts

Ref. Desig.	Keysight Part No.	Description
ELECTRICAL PARTS		
C1	0160-5422	Capacitor 0.047 μ F 20%
C2	0160-4808	Capacitor 470pF 5%
C4	0160-4787	Capacitor 22pF 5% 100V
C5	0180-0155	Capacitor 2.2 μ F 20V
C6,7	0160-5422	Capacitor 0.047 μ F 20%
C8	0160-4835	Capacitor 0.1 μ F 10% 50V
C10-12,14-16	0160-5422	Capacitor 0.047 μ F 20%
C17	0180-0155	Capacitor 2.2 μ F 20V
D1,2	1906-0229	Diode array 50V
J2	1251-4927	Receptacle LCD display
J3	1251-4926	Receptacle test header
J4,5	1252-0718	Receptacle (A3G1, A3G2)
J6	1251-8184	Receptacle phone (GPIB board)
L1	9140-0158	Inductor 1 μ H 10%
R1	1810-0560	Resistor network DIP
R2	0698-3359	Resistor 12.7K 1%
R23-25,27-30	0698-3155	Resistor 4.64K 1%
R37	1810-0371	Resistor network SIP
R38	0698-3441	Resistor 215 Ω 1% 0.125W
R39,40	0698-3155	Resistor 4.64K 1%
RT1	0837-0412	Thermistor
VR16	1902-0950	Diode zener 4.7V 5
U3	1820-6721	IC MPU
U4	5080-2466	ROM programmed front panel
U6	1818-4792	IC memory
U8	1820-2724	IC SN74ALS573BN
W3	1258-0209	Jumper (J3)
W5	0811-3590	Jumper
Y1	0410-2159	Crystal 10Mhz
MECHANICAL PARTS		
--	1200-1274	Socket IC (U3)
--	1200-1417	Socket IC (U4)
--	0340-1277	Insulator (Y1)

Table 5-5. A2 Isolator Board Replaceable Parts for 657xA only

Ref. Desig.	Keysight Part No.	Description
ELECTRICAL PARTS		
C800	0160-5422	Capacitor 0.047 μ F 20%
C801	0160-4822	Capacitor 1000pF 5%
C802	0160-4822	Capacitor 1000pF 5%
C803	0180-3167	Capacitor 1000 μ F 25V
C804	0180-4129	Capacitor 1 μ F 35V
C805	0160-5422	Capacitor 0.047 μ F 20%
C806	0160-5422	Capacitor 0.047 μ F 20%
CR800	1901-0731	Diode power rectifier
CR801	1901-0731	Diode power rectifier
CR802	1901-0731	Diode power rectifier
CR803	1901-0731	Diode power rectifier
F800	2110-0951	Fuse subminiature 5 AT
J800,801	1251-8184	Receptacle modular phone
J802	1251-4926	Connector test-point header
J803	1251-4245	Connector 2-pin male
R800	0757-0401	Resistor 100 Ω 1% 0.125W
R801	0698-3155	Resistor 4.64K 1%
R802	0698-3155	Resistor 4.64K 1%
R803	0698-0082	Resistor 464 Ω 1% 0.125W
R804	0698-0082	Resistor 464 Ω 1% 0.125W
R805	0698-3155	Resistor 4.64K 1%
R806	0698-3155	Resistor 4.64K 1%
R807	0698-3155	Resistor 4.64K 1%
U800	1990-0543	IC Opto isolator
U801	1990-0444	IC Opto isolator
U802	1990-0444	IC Opto isolator
U803	1820-1201	IC SN74LS08N
U804	1820-1438	IC SN74LS257N
U805	1826-0122	IC UA7805UC
	5060-2948	Heat sink assembly TO-220 (U805)
	1205-0282	Heat sink

Table 5-6. A2 GPIB Board Replaceable Parts (see Note)

Ref. Desig.	Keysight Part No.	Description
ELECTRICAL PARTS		
C122	0180-4606	Capacitor 10,000 μ F
C128	0160-4281	Capacitor 2,200pF
F101	2110-0699	Fuse Subminiature 5AM
J101	1252-2320	Connector Receptacle (GPIB)
J106	1251-4926	Connector Receptacle (Test Header)
J107	1251-7330	Connector Receptacle
J108	1251-7330	Connector Receptacle
J114	1251-7330	Connector Receptacle
J115	1251-7330	Connector Receptacle
P101	1251-4245	Connector Plug 2-pin (AC Bias)
U110, U111	1990-0444	IC Optoisolator
U113	1990-0543	IC Optoisolator
U117	1820-2549	IC Optoisolator
U118	1820-4185	IC Optoisolator
U121	1820-0430	IC Voltage regulator
TB101	0360-2312	Terminal Block (Digital Control)
MECHANICAL PARTS		
--	1205-0758	Heatsink (U121)
--	0535-0031	Nut hex w/lockwasher (J101)
--	0515-0642	Screw (U121)
--	0515-0911	Screw M3x0 5 (J101)
Note: All other parts are surface mounted and are not field repairable		

Table 5-7. A3 FET Board Replaceable Parts

Ref. Desig.	Keysight Part No.	Description
ELECTRICAL PARTS		
C201	0160-7505	Capacitor 7 μ F 200V 5%
C210, C211, C213, C214	0160-6838	Capacitor 2200pF 1000V 20%
C244, C245	1826-0138	Capacitor 0.1 μ F 400V 10%
L206, L208, L209, L211	9170-2122	Inductor, Core-toroid
J200	1252-0055	Connector Receptacle
J201	1251-7616	Connector Receptacle
J202	1252-2503	Connector Receptacle
Q201, Q202, Q203, Q204	1854-1784	Transistor MOSFET VCE 600V IC 40A (matched set)
R201	0699-7384	Resistor 150 Ω 1% 30W
R213, R216, R220, R224	0699-7383	Resistor 75 Ω 1% 30W
T202	9100-4350	Transformer-Current
T204	06624-80091	Transformer-Pulse
--	5188-4203	Cable assembly (J201)
--	5188-4208	Cable assembly (J202)
MECHANICAL PARTS		
--	2110-1319	Fuse clip (qty 4)
--	0380-1660	Spacer-round (qty 4)
--	0515-0375	Screw M3x0.5 16mm (qty 4)
--	0515-0664	Screw M3x0.5 12mm (qty 9)
--	5188-4201	Thermal Pad (FET to heatsink)
--	5188-4202	Insulator (PCA to heatsink)
--	5002-2818	Heatsink
Note: All other parts are surface mounted and are not field repairable		

Table 5-8. A4 AC Input Board Replaceable Parts

Ref. Desig.	Keysight Part No.	Description
ELECTRICAL PARTS		
C304	0160-4834	Capacitor .047 μ F 10%
C305	0180-3458	Capacitor 4700 μ F 50V
C306,307	0180-4129	Capacitor 1 μ F 35V
C309	0180-4136	Capacitor 10 μ F 20V
C310	0160-4834	Capacitor .047 μ F 10%
C311	0180-3458	Capacitor 4700 μ F 50V
C312	0180-3587	Capacitor 1000 μ F 50V
C313-315,317,318	0180-4129	Capacitor 1 μ F 35V
C320,322	0180-4131	Capacitor 4.7 μ F 35V
C351	0180-3458	Capacitor 4700 μ F 50V
C352-354	0180-0230	Capacitor 1 μ F 50V
C357	0160-4554	Capacitor .01 μ F 20%
C358,359	0160-4835	Capacitor 0.1 μ F 10% 50V
C360,361	0180-3587	Capacitor 1000 μ F 50V
C420,421,423	0160-7606	Capacitor 1 μ F @250V
C425,426	0160-4439	Capacitor 4700pF
C427	0160-4065	Capacitor 0 1 μ F
C430	0160-4355	Capacitor 0.01 μ F 10%
C431	0160-4065	Capacitor 0.1 μ F
C497,498	0160-7606	Capacitor 1 μ F 250V
CR402	1990-0517	LED visible
D306-310,312-317	1901-0731	Diode, power rectifier
D318,319	1901-1098	Diode 1N4150
D400	1906-0389	Diode, full-wave bridge
E403,404,411,412	1251-5613	CONN-SGL CONN
F304	2110-0304	Fuse 1.5AT 250V
F308	2110-0202	Fuse 0.5AT 250V
F400	2110-0849	Fuse 25AM 250V
F401	2110-0098	Fuse 20AM 250V
FL1		(see Table 5-3)
J301,302,40p	1252-0055	Connector-POST-TP HDR
J500	1251-8837	Connector-POST-TP-HDR
K400,401	0490-1746	Relay IC 30A @ 30Vdc, 15Vdc coil
L402	06012-80095	Inductor, output choke
R315	0698-8672	Resistor 243.4 Ω 0 1%
R316	0698-0085	Resistor 2.61K 1%
R317	8159-0005	Resistor 0 Ω
R326	0698-8672	Resistor 243.4 Ω 0.1%
R327	0757-0281	Resistor 2.74K 1%
R328	0757-0281	Resistor 2.74K 1%
R329	0698-8672	Resistor 243.4 Ω 0.1%
R330,331	8159-0005	Resistor 0 Ω
R332	0764-0041	Resistor 30 Ω 5% 2W
R333	8159-0005	Resistor 0 Ω
R339	0698-3155	Resistor 4.64K 1%
R350	0757-0434	Resistor 3.65K 1%

Table 5-8. A4 AC Input Board Replaceable Parts (continued)

Ref. Desig.	Keysight Part No.	Description
ELECTRICAL PARTS (continued)		
R351	0698-3155	Resistor 4.64K 1%
R352	0757-0280	Resistor 1K 1% 0.125W
R361	0698-5090	Resistor 43K 1% 0.125W
R362	0698-3201	Resistor 80K 1% 0.125W
R363	0698-5090	Resistor 43K 1% 0.125W
R364	0764-0015	Resistor 560 Ω 5% 2W
R367	0757-0401	Resistor 100 Ω 1% 0.125W
R368	0757-0444	Resistor 12.1K 1%
R369,370	0698-8812	Resistor 1 Ω 1% 0.25W F
R371,372	0757-0465	Resistor 100K 1%
R373	0757-0401	Resistor 100 Ω 1% 0.125W
R374	0698-3155	Resistor 4.64K 1%
R375,376	0757-0346	Resistor 10 Ω 1% 0.125W
R377	0698-3642	Resistor 3K 5% 2W
R378	0683-6845	Resistor 680K 5% 0.25W
R379	0698-3155	Resistor 4.64K 1%
R380	0698-3620	Resistor 100 Ω 5% 2W
R381	0698-4150	Resistor 115 Ω 1% 0.25W
R382	0683-3305	Resistor 33 Ω 5% 0.25W
R383	0757-0401	Resistor 100 Ω 1% 0.125W
R384	0757-0280	Resistor 1K 1% 0.125 W
R399	0699-0208	Resistor 1 Ω 5% 0.25W
R400,401	0699-3191	Resistor 27 Ω 5% 20W
R404	0764-0028	Resistor 100K 5% 2W
R409	0811-1918	Resistor 30K 5% 10W
R414	0811-1666	Resistor 1 Ω 5% 2W
RT300	0837-0412	Thermistor
SW300	3101-2828	Switch DPDT, line-voltage select
T300	9100-4908	Transformer, bias GPIB
U302	5060-2942	Assembly (IC and heatsink)
	1826-0393	IC LM317T (U302)
U304	5060-3324	Assembly (transistor and heatsink)
	1853-0490	Transistor PNP (U304)
U305	5060-3325	Assembly (IC and heatsink)
	1826-0393	IC LM317T (U305)
U306	5060-2943	Assembly (IC and heatsink)
	1826-0527	IC LM337T (U306)
U307	5060-2948	Assembly (IC and heatsink)
	1826-0122	IC UA7805UC (U307)
U308	1826-2341	IC, voltage sense
U309	1990-1351	Optoisolator
U310	1858-0047	Transistor array 16P-DIP
U311	1826-0346	IC op amp
--	5080-2172	Cable assembly (SW 300)

Table 5-8. A4 AC Input Board Replaceable Parts (continued)

Ref. Desig.	Keysight Part No.	Description
MECHANICAL PARTS		
--	2110-0726	Fuse clip (F304,308,401)
--	2110-0870	Fuse clip 13/32 (F400)
--	1205-0282	Heatsink (U302,306,307)
--	1205-0402	Heatsink (U304,305)
--	0590-1397	Nut (F400 clips)
--	0515-0070	Screw M4 x 0.7 (F400 clips)
--	0515-0981	Screw M4 x 0.7 (D400)
--	2190-0009	Washer lock internal (F400 clips)
--	2190-0586	Washer lock (F400 heatsinks)

Table 5-9. A5 Control Board Replaceable Parts

Ref. Desig.	Keysight Part No.	Description
ELECTRICAL PARTS		
C501	0160-5422	Capacitor 0.047 μ F 20%
C502,503	0160-4805	Capacitor 47pF 5% 100V
C504	0160-5422	Capacitor 0.047 μ F 20%
C505	0180-4129	Capacitor 1 μ F 35V
C507,509	0160-5422	Capacitor 0.047 μ F 20%
C510	0160-4801	Capacitor 100pF 5%
C512	0160-5422	Capacitor 0.047 μ F 20%
C513	0160-4801	Capacitor 100pF 5%
C515	0160-5422	Capacitor 0.047 μ F 20%
C516	0160-4801	Capacitor 100pF 5%
C515,517,518	0160-5422	Capacitor 0.047 μ F 20%
C519	0180-4129	Capacitor 1 μ F 35V
C520,521	0160-5469	Capacitor 1 μ F 10% 50V
C523	0160-4846	Capacitor 1500pF 100V
C524	0160-5422	Capacitor 0.047 μ F 20%
C530	0180-4129	Capacitor 1 μ F 35V
C531,532	0160-5422	Capacitor 0.047 μ F 20%
C533	0180-4131	Capacitor 4.7 μ F 35V
C550-555	0160-4835	Capacitor 0.1 μ F 10% 50V
C556-558	0180-4129	Capacitor 1 μ F 35V
C600	0180-4131	Capacitor 4.7 μ F 35V
C601	0160-4835	Capacitor 0.1 μ F 10% 50V
C602	0160-4805	Capacitor 47pF 5% 100V
C603,604	0160-4810	Capacitor 330pF 5%
C610	0160-4807	Capacitor 33pF 5% 100V
C620	0160-4904	Capacitor 6800pF 5%
C621	0160-4791	Capacitor 10pF 5% 100V
C622	0160-4795	Capacitor 4.7pF
C623	0160-4904	Capacitor 6800pF 5%
C624	0160-4787	Capacitor 22pF 5% 100V
C625	0160-4795	Capacitor 4.7pF
C626	0180-4129	Capacitor 1 μ F 35V
C630 (<i>Model specific</i>)		
6571A-6573A, 6671A-6673A	0160-4801	Capacitor 100pF 5%
6574A, 6575A, 6674A, 6675A	0160-4787	Capacitor 22pF 5%
C631	0160-4799	Capacitor 2.2pF
C632 (<i>Model specific</i>)		
6571A-6573A, 6671A-6673A	0160-4801	Capacitor 100pF 5%
6574A, 6575A, 6674A, 6675A	0160-4787	Capacitor 22pF 5%
C655 (<i>Model specific</i>)		
6571A-6574A, 6671A-6674A	0160-4831	Capacitor 4700pF 10%
6575A, 6675A	0160-4819	Capacitor 2200pF 5%

Table 5-9. A5 Control Board Replaceable Parts (continued)

Ref. Desig.	Keysight Part No.	Description
ELECTRICAL PARTS		
C660	0160-4822	Capacitor 1000pF 5%
C670 (<i>Model specific</i>) 6571A-6574A, 6671A-6674A 6575A, 6675A	0160-5098	Capacitor 0.22μF 10%
C671	0160-4835	Capacitor 0.1μF 10% 50V
C672	0160-5469	Capacitor 1μF 10% 50V
C680 (<i>Model specific</i>) 6571A, 6671A 6572A, 6672A 6573A, 6673A, 6574A, 6674A 6575A, 6675A	0160-4795	Capacitor 4.7pF
C681 (<i>Model specific</i>) 6571A, 6671A 6572A, 6672A 6573A, 6673A 6574A, 6674A 6575A, 6675A	0160-4822	Capacitor 1000pF 5%
	0160-4829	Capacitor 680pF 10%
	0160-4808	Capacitor 470pF 5%
	0160-4813	Capacitor 180pF 5%
C682	0160-4832	Capacitor 0.01μF 10%
C683 (<i>Model specific</i>) 6571A, 6671A 6572A, 6672A 6573A, 6673A 6574A, 6674A 6575A, 6675A	0160-4904	Capacitor 6800pF 5%
	0160-4831	Capacitor 4700pF 10%
	0160-5410	Capacitor 3300pF 5%
	0160-4799	Capacitor 2.2pF
C684 (<i>Model specific</i>) 6571A, 6671A 6572A, 6672A 6573A, 6673A, 6574A, 6674A 6575A, 6675A	0160-5468	Capacitor 0.47μF 50V
	0160-5469	Capacitor 1μF 10%
	0160-7277	Capacitor 2.2μF 10% 50V
	0160-7308	Capacitor 3.3μF 10% 50V
C685 (<i>Model specific</i>) 6571A, 6671A 6572A, 6672A 6573A-6575A, 6673A-6675A	0160-5469	Capacitor 1μF 10% 50V
	0160-7277	Capacitor 2.2μF 10%
	0160-7308	Capacitor 3.3μF 10% 50V
C690 (<i>Model specific</i>) 6571A, 6671A, 6572A, 6672A 6573A, 6673A, 6574A,6674A 6575A, 6675A	0160-4795	Capacitor 4.7pF
	0160-4799	Capacitor 2.2pF
	0160-4795	Capacitor 4.7pF
C691,692 (<i>Model specific</i>) 6571A, 6671A 6572A, 6672A 6573A, 6673A 6574A,6674A, 6575A, 6675A	0160-5469	Capacitor 1μF 50V
	0160-5892	Capacitor 0.22μF
	0160-5579	Capacitor 0.047μF
	0160-5578	Capacitor 0.022μF
C695,696	0160-4791	Capacitor 10pF 5% 100V
C700	0160-4822	Capacitor 1000pF 5%
C701	0160-4834	Capacitor 0.047μF 10%

Table 5-9. A5 Control Board Replaceable Parts (continued)

Ref. Desig.	Keysight Part No.	Description
ELECTRICAL PARTS		
C704 (<i>Model specific</i>)		
6571A, 6671A	0160-4808	Capacitor 470pF 5%
6572A, 6672A,	0160-4821	Capacitor 1200pF 5%
6573A, 6673A		
6574A, 6674A	0160-4808	Capacitor 470pF 5%
6575A, 6675A	0160-4821	Capacitor 1200pF 5%
C706	0160-4795	Capacitor 4.7pF
C710,711	0160-4835	Capacitor 0.1μF 10% 50V
C712 (<i>Model specific</i>)		
6571A-6574A,	0160-4808	Capacitor 470pF 5%
6671A-6674A		
6575A, 6675A	0160-4813	Capacitor 180pF 5%
C714 (<i>Model specific</i>)		
6571A-6574A,	0160-4808	Capacitor 470pF 5%
6671A-6674A		
6575A, 6675A	0160-4812	Capacitor 220pF 5%
C715	0160-4805	Capacitor 47pF 5% 100V
C716 (<i>Model specific</i>)		
6571A, 6671A,	0160-5098	Capacitor 0.22μF 10%
6572A, 6672A		
6573A, 6673A	0160-4835	Capacitor 0.1μF 10% 50V
6574A, 6575A,	0160-4834	Capacitor 0.47μF 10%
6674A, 6675A		
C717 (<i>Model specific</i>)		
6571A-6574A,	0160-4808	Capacitor 470pF 5%
6671A-6674A		
6575A, 6675A	0160-4812	Capacitor 220pF 5%
C719	0160-4835	Capacitor 0.1μF 10% 50V
C720	0160-5469	Capacitor 1μF 10% 50V
C722 (<i>Model specific</i>)		
6571A, 6671A, 6672A	0160-5892	Capacitor 0.22μF 10%
6573A, 6673A, 6674A	0160-5468	Capacitor 0.47μF 50V
6575A, 6675A	0160-7277	Capacitor 2.2μF 50V
C723	0160-4835	Capacitor 0.1μF 10% 50V
C724	0160-4832	Capacitor 0.01μF 10%
C731	0160-4791	Capacitor 10pF 5% 100V
C732	0160-4787	Capacitor 22pF 5% 100V
C733	0160-4797	Capacitor 3.3pF
C734,735	0160-4835	Capacitor 0.1μF 10% 50V
C736	0160-4797	Capacitor 3.3pF
C737	0160-5098	Capacitor 0.22μF 10%
C738	0160-4811	Capacitor 270pF 5%
C739	0160-4799	Capacitor 2.2pF
C740	0160-4795	Capacitor 4.7pF
C741	0160-4835	Capacitor 0.1μF 10% 50V

Table 5-9. A5 Control Board Replaceable Parts (continued)

Ref. Desig.	Keysight Part No.	Description
ELECTRICAL PARTS		
C750,751 (<i>Model specific</i>)		(Not used)
6571A, 6671A		
6572A, 6672A	0160-4829	Capacitor 680pF 10%
6573A, 6673A, 6574A, 6674A	0160-4822	Capacitor 1000pF 5%
6575A, 6675A	0160-0178	Capacitor 470pF 5%
C760	0160-4788	Capacitor 18pF 5% 100V
C851	0160-4835	Capacitor 0.1μF 10% 50V
C852	0160-4183	Capacitor 1000pF 20%
C855	0160-5098	Capacitor 0.22μF 10%
C885,894,895	0160-4835	Capacitor 0.1μF 10% 50V
C892,893	0180-4136	Capacitor 10μF 20V
C896	0160-4183	Capacitor 1000pF 20%
C899	0160-4835	Capacitor 0.1μF 10% 50V
C900	0160-4801	Capacitor 100pF 5%
D530	1901-1098	Diode 1N4150
D605,610-613,615	1901-1098	Diode 1N4150
D618	1901-0880	Diode GEN PRP
D620,621,626,627,630,631, 641	1901-1098	Diode 1N4150
D651	1901-0880	Diode GEN PRP
D660,661	1901-1098	Diode 1N4150
D662-665	1901-0880	Diode GEN PRP
D666-668	1901-1098	Diode 1N4150
D676	1901-0880	Diode GEN PRP
D677	1901-1098	Diode 1N4150
D678	1901-0880	Diode GEN PRP
D679,680	1901-1098	Diode 1N4150
D685	1901-0880	Diode GEN PRP
D686	1901-1098	Diode 1N4150
D687	1901-0880	Diode GEN PRP
D688,689	1901-1098	Diode 1N4150
D690-692	1901-0731	Diode PWR RECT
D693	1901-0880	Diode GEN PRP
J501	1252-3693	Connector
J502	1251-7330	Receptacle modular phone
J503	1252-0055	Connector POST-TP HDR
J509	1252-1992	Connector POST-TP-HDR
J510	1251-8666	Connector POST-TP
L001	9140-0158	Inductor 1μH 10%
Q602	1853-0510	Transistor PNP
R501	0698-3456	Resistor 287K 1%
R502	1810-0305	Resistor network SIP
R504 (<i>Model specific</i>)		
6571A, 6671A	0757-0123	Resistor 34.8K 1%
6572A-6574A, 6672A-6674A	0698-6983	Resistor 20.4K 0.1%
6575A, 6675A	0699-1212	Resistor 19K 0.1%

Table 5-9. A5 Control Board Replaceable Parts (continued)

Ref. Desig.	Keysight Part No.	Description
ELECTRICAL PARTS		
R505 (<i>Model specific</i>)		
6571A, 6671A	0698-7163	Resistor 2.0081K 0.1%
6572A-6574A, 6672A-6674A 6575A, 6675A	0698-6631	Resistor 2.5K 0.1%
R506	0698-6348	Resistor 3K 0.1% 0.125W
R507	0699-1212	Resistor 19K 0.1%
R508	0698-6392	Resistor 22K 0.1% 0.125W
R509-511	0757-0442	Resistor 10K 1% 0.125W
R512	0757-0401	Resistor 100 Ω 1% 0.125W
R513,514	0698-3456	Resistor 287K 1%
R515	0757-0465	Resistor 100K 1%
R516,517	0757-0462	Resistor 75K 1% 0.125W
R520	0698-4486	Resistor 24.9K 1%
R521	0757-0442	Resistor 10K 1% 0.125W
R530	8159-0005	Resistor 0 Ω
R531	0757-0442	Resistor 10K 1% 0.125W
R532	0757-0280	Resistor 1K 1% 0.125W
R533,534	0698-8827	Resistor 1M 1% 0.125W
R535	0698-3162	Resistor 46.4K 1%
R540	0757-0280	Resistor 1K 1% 0.125W
R541	0757-0273	Resistor 3.01K 1%
R542	0698-3155	Resistor 4.64K 1%
R543	0757-0442	Resistor 10K 1% 0.125W
R544	0757-0289	Resistor 13.3K 1%
R601	0757-0472	Resistor 200K 1%
R603	0757-0273	Resistor 3.01K 1%
R604	0757-0442	Resistor 10K 1% 0.125W
R605,606	0757-0199	Resistor 21.5K 1%
R608	0757-0442	Resistor 10K 1% 0.125W
R609	0757-0273	Resistor 3.01K 1%
R610	0757-0407	Resistor 200 Ω 1% 0.125W
R611	0757-0273	Resistor 3.01K 1%
R612	0757-0407	Resistor 200 Ω 1% 0.125W
R620	0757-0273	Resistor 3.01K 1%
R621	0698-3279	Resistor 4.99K 1%
R623	0698-4479	Resistor 14K 1% 0.125W
R624	0757-0465	Resistor 100K 1%
R625	0757-0442	Resistor 10K 1% 0.125W
R626	0698-3155	Resistor 4.64K 1%
R627	0698-3162	Resistor 46.4K 1%
R630	0757-0429	Resistor 1.82K 1%
R631	0757-0434	Resistor 3.65K 1%
R632	0698-3450	Resistor 42.2K 1%
R633,634	0757-0407	Resistor 200 Ω 1% 0.125W
R635,636	0698-4486	Resistor 24.9K 1%
R637	0757-0472	Resistor 200K 1%
	0757-0434	Resistor 3.65K 1%

Table 5-9. A5 Control Board Replaceable Parts (continued)

Ref. Desig.	Keysight Part No.	Description
ELECTRICAL PARTS		
R638	0699-0070	Resistor 3.16M 1%
R639	0757-0407	Resistor 200 Ω 1% 0.125W
R640	0757-0442	Resistor 10K 1% 0.125W
R641	0699-0070	Resistor 3.16 M 1%
R642,643	0757-0472	Resistor 200K 1%
R644	0757-0280	Resistor 1K 1% 0.125W
R645	0757-0442	Resistor 10K 1% 0.125W
R650	0757-0453	Resistor 30.1K 1%
R651,652 (<i>Model specific</i>)		
6571A, 6671A	0757-0453	Resistor 30.1K 1%
6572A, 6672A	0757-0462	Resistor 75K 1% 0.125W
6573A, 6673A	0757-0468	Resistor 130K 1%
6574A, 6674A	0757-0473	Resistor 221K 1%
6575A, 6675A	0698-3260	Resistor 464K 1%
R653	0757-0453	Resistor 30.1K 1%
R662,663	0757-0410	Resistor 301 1% 0.125W
R664	0698-3155	Resistor 4.64K 1%
R665,666 (<i>Model specific</i>)		
6571A, 6671A		(Not used)
6572A, 6672A	0757-0199	Resistor 21.5K 1%
6573A, 6673A	0757-0441	Resistor 8.25K 1%
6574A, 6674A	0757-0447	Resistor 16.2K 1%
6575A, 6675A	0698-3157	Resistor 19.6K 1%
R667	0698-3279	Resistor 4.99K 1%
R669	0698-0082	Resistor 464 Ω 1% 0.125W
R670	0757-0199	Resistor 21.5K 1%
R671	0698-3279	Resistor 4.99K 1%
R672	0757-0472	Resistor 200K 1%
R674	0757-0465	Resistor 100K 1%
R678 (<i>Model specific</i>)		
6571A, 6671A	0698-3450	Resistor 42.2K 1%
6572A, 6672A	0757-0457	Resistor 47.5K 1%
6573A, 6673A,	0698-3450	Resistor 42.2K 1%
6574A, 6674A		
6575A, 6675A	0698-3162	Resistor 46.4K 1%
R679 (<i>Model specific</i>)		
6571A-6574A,	0698-3155	Resistor 4.64K 1%
6671A-6674A		
6575A, 6675A	0757-0442	Resistor 10K 1% 0.125W
R680	0698-3279	Resistor 4.99K 1%
R682 (<i>Model specific</i>)		
6571A, 6671A	0757-0123	Resistor 34.8K 1%
6572A, 6672A	0698-3450	Resistor 42.2K 1%
6573A, 6673A	0757-0124	Resistor 39.2K 1%
6574A, 6674A	0698-3450	Resistor 42.2K 1%
6575A, 6675A	0698-3162	Resistor 46.4K 1%

Table 5-9. A5 Control Board Replaceable Parts (continued)

Ref. Desig.	Keysight Part No.	Description
ELECTRICAL PARTS		
R685 (<i>Model specific</i>) 6571A-6574A, 6671A-6674A 6575A, 6675A	0757-0410	Resistor 301 Ω 1% 0.125W
	0757-0413	Resistor 392 Ω 1% 0.125W
R687 (<i>Model specific</i>) 6571A-6574A, 6671A-6674A 6575A, 6675A	0757-0434	Resistor 3.65K 1%
	0757-0443	Resistor 11K 1%
R688	0757-0429	Resistor 1.82K 1%
R689 (<i>Model specific</i>) 6571A, 6671A 6572A, 6672A 6573A, 6673A 6574A, 6674A 6575A, 6675A	0757-0472	Resistor 200K 1%
	0698-3450	Resistor 42.2K 1%
	0698-3260	Resistor 464K 1%
	0698-8827	Resistor 1 M 1% 0.125W
	0757-0472	Resistor 200K 1%
R690 (<i>Model specific</i>) 6571A, 6671A 6572A, 6672A 6573A, 6673A 6574A, 6674A 6575A, 6675A	0757-0453	Resistor 30.1K 1%
	0698-1254	Resistor 536K 1%
	0757-0480	Resistor 432K 1%
	0699-1254	Resistor 536K 1% 0.125W
	0699-0070	Resistor 3.16 M 1%
R691 (<i>Model specific</i>) 6571A, 6671A 6572A, 6672A 6573A, 6673A 6574A, 6674A 6575A, 6675A	0757-0442	Resistor 10K 1% 0.125W
	0757-0451	Resistor 24.4K 1%
	0698-3450	Resistor 42.2K 1%
	0757-0462	Resistor 75K 1% 0.125W
	0698-3460	Resistor 422K 1%
R692 (<i>Model specific</i>) 6571A, 6671A, 6572A, 6672A 6573A, 6673A, 6574A, 6674A 6575A, 6675A	0698-8827	Resistor 1M 1% 0.125W
	0699-0070	Resistor 3.16M 1%
		(Not used)
R693 (<i>Model specific</i>) 6571A-6574A, 6671A-6674A 6575A, 6675A	0698-3558	Resistor 4.02K 1% 0.125W
	0757-0442	Resistor 10K 1%
R694	0699-0070	Resistor 3.16 M 1%
R696 (<i>Model specific</i>) 6571A-6574A, 6671A-6674A 6575A, 6675A	0757-0468	Resistor 130K 1% 0.125W
	0698-4536	Resistor 340K 1%
R697 (<i>Model specific</i>) 6571A, 6671A 6572A, 6672A 6573A, 6673A 6574A, 6674A 6575A, 6675A	8159-0005	Resistor 0 Ω
	0698-8827	Resistor 1 M 1% 0.125W
	8159-0005	Resistor 0 Ω
	0699-0070	Resistor 3.16 M 1%
		(Not used)

Table 5-9. A5 Control Board Replaceable Parts (continued)

Ref. Desig.	Keysight Part No.	Description
ELECTRICAL PARTS		
R698	0699-0070	Resistor 3.16 M 1%
R699	0699-0088	Resistor 1.2 M 1%
R702 (<i>Model specific</i>)		
6571A, 6671A	0757-0429	Resistor 1.82K 1%
6572A-6575A, 6672A-6675A	0757-0280	Resistor 1K 1% 0.125W
R703 (<i>Model specific</i>)		
6571A, 6671A	0699-1254	Resistor 536K
6572A-6575A, 6672A-6675A	0698-3162	Resistor 46.4K 1%
R710	0698-3155	Resistor 4.64K 1%
R712 (<i>Model specific</i>)		
6571A, 6671A	0757-0460	Resistor 61.9K 1%
6572A, 6672A	0757-0458	Resistor 51.1K 1%
6573A, 6673A	0698-3454	Resistor 215K 1%
6574A, 6674A	0757-0469	Resistor 150K 1%
6575A, 6675A	0757-0280	Resistor 1K 1% 0.125W
R713 (<i>Model specific</i>)		
6571A, 6671A	0698-8827	Resistor 1M 1% 0.125W
6572A, 6672A	0699-0088	Resistor 1.21M 1%
6573A, 6673A, 6574A, 6674A	0683-2755	Resistor 2.7M 1% 0.25W
6575A, 6675A	0683-6855	Resistor 6.8M 5% 0.25W
R715	0698-3279	Resistor 4.99K 1%
R717	0699-0070	Resistor 3.16M 1%
R718	0699-0461	Resistor 30K 0.1% 0.1W
R719 (<i>Model specific</i>)		
6571A, 6671A	0699-0460	Resistor 85K 0.1% 0.1W
6572A-6574A, 6672A-6674A	0699-1211	Resistor 95K 0.1%
6575A, 6675A	0699-2295	Resistor 100K 0.1% 0.1W
R720	0699-2247	Resistor 121K 0.05%
R721.722	0699-0461	Resistor 30K 0.1% 0.1W
R723,724	0757-0468	Resistor 130K 1%
R730,731 (<i>Model specific</i>)		
6571A, 6671A, 6572A, 6672A	0699-2246	Resistor 25K 0.05%
6573A, 6673A	0699-1513	Resistor 40K 0.05% 0.1W
6574A, 6674A	0699-2248	Resistor 47.5K 0.05%
6575A, 6675A	0699-1510	Resistor 22.22K 0.05%
R732,733 (<i>Model specific</i>)		
6571A, 6671A	0698-7163	Resistor 2.0081K 0.1%
6572A, 6672A	0699-0924	Resistor 11K 0.1%
6573A, 6673A	0698-3956	Resistor 42.5K 0.1%
6574A, 6575A, 6674A, 6675A	0698-6342	Resistor 90K 1%

Table 5-9. A5 Control Board Replaceable Parts (continued)

Ref. Desig.	Keysight Part No.	Description
ELECTRICAL PARTS		
R740,741 (<i>Model specific</i>)		
6571A, 6671A	0757-0280	Resistor 1K 1% 0.125W
6572A, 6672A	0757-0429	Resistor 1.82K 1%
6573A, 6673A	0698-3279	Resistor 4.99K 1%
6574A, 6674A	0757-0442	Resistor 10K 1% 0.125W
6575A, 6675A	0757-0447	Resistor 16.2K 1%
R750	0698-8093	Resistor 40K 0.1% 0.1W
R752	0757-0199	Resistor 21.5K 1%
R761,762	0698-3430	Resistor 21.5 1%
R765	8159-0005	Resistor 0 Ω
R766	0698-8093	Resistor 40K 0.1% 0.1W
R767 (<i>Model specific</i>)		
6571A-6573A, 6671A-6673A	0699-1741	Resistor 5.657K 0.1%
6574A, 6674A	0699-0055	Resistor 4.53K 0.1%
6575A, 6675A	0699-1741	Resistor 5.657K 0.1%
R768 (<i>Model specific</i>)		
6571A, 6671A	0757-0410	Resistor 301 Ω 1% 0.125W
6572A, 6672A, 6573A, 6673A	0699-0083	Resistor 681 Ω 0.1% 0.1W
6574A, 6674A	0699-0211	Resistor 859 Ω 0.1%
6575A, 6675A	0698-7163	Resistor 2.0081K 0.1%
R769	0698-3279	Resistor 4.99K 1%
R770 (<i>Model specific</i>)		
6571A, 6671A, 6572A, 6672A	0698-3155	Resistor 4.64K 1%
6573A, 6673A, 6574A, 6674A	0757-0429	Resistor 1.82K 1%
6575A, 6675A	0757-0419	Resistor 681 Ω 0.1% 0.125W
R785 (<i>Model specific</i>)		
6571A, 6671A	0757-0472	Resistor 200K 1%
6572A, 6672A	0757-0473	Resistor 221K 1%
6573A, 6673A	0698-4536	Resistor 340K 1%
6574A, 6674A	0757-0471	Resistor 182K 1%
6575A, 6675A	0698-3455	Resistor 261K 1%
R790,791	0698-8093	Resistor 40K 0.1% 0.1W
R792,793	0698-6414	Resistor 1K 0.1% 0.1W F
R794,795	0698-6323	Resistor 100 Ω 0.1%
R801	0757-0447	Resistor 16.2K 1%
R802	0757-0468	Resistor 130K 1%
R803	0757-0462	Resistor 75K 1% 0.125W
R804	0757-0468	Resistor 130K 1%
R805 (<i>Model specific</i>)		
6571A, 6671A	0699-3103	Resistor 19K 0.05%
6572A-6575A, 6672A-6675A	0699-2246	Resistor 25K 0.05%

Table 5-9. A5 Control Board Replaceable Parts (continued)

Ref. Desig.	Keysight Part No.	Description
ELECTRICAL PARTS		
R807	0698-8827	Resistor 1M 1% 0.125W
R808	0757-0407	Resistor 200 Ω 1% 0.125W
R809 (<i>Model specific</i>)		
6571A, 6671A	0699-0489	Resistor 16.15K 0.01%
6572A, 6672A, 6573A, 6673A 6574A, 6674A 6575A, 6675A	0699-3103	Resistor 19K 0.05%
	0699-0489	Resistor 16.15K 0.01%
	0699-1510	Resistor 22.2K 0.05%
R810	0698-8093	Resistor 40K 0.1% 0.1W
R820,821	0757-0460	Resistor 61.9K 1%
R822,823	0698-3450	Resistor 42.2K 1%
R824,825	0757-0442	Resistor 10K 1% 0.125W
R827	0698-4123	Resistor 499 Ω 0.125W
R828	0757-0453	Resistor 30.1K 1%
R831	0757-0429	Resistor 1.82K 1%
R832	0757-0273	Resistor 3.01K 1%
R833	0698-3450	Resistor 42.2K 1%
R834	0757-0280	Resistor 1K 1% 0.125W
R835	0757-0465	Resistor 100K 1%
R836	0698-4479	Resistor 14K 1% 0.125W
R837	0698-3456	Resistor 287K 1%
R839	0699-0088	Resistor 1.2M 1%
R840	0698-8827	Resistor 1 M 1% 0.125W
R851	0698-3155	Resistor 4.64K 1%
R852	0757-0472	Resistor 200K 1%
R853	0698-3279	Resistor 4.99K 1%
R854	0683-2255	Resistor 2.2M 5% 0.25W
R855	0698-0082	Resistor 464 Ω 1% 0.125W
R860	0683-1005	Resistor 10 Ω 5% 0.25W
R861	0698-4123	Resistor 499 Ω 1% 0.125W
R862	0757-0273	Resistor 3.01K 1%
R870,871	0698-3430	Resistor 21.5 Ω 1%
R880	0698-3279	Resistor 4.99K 1%
R885	0757-0283	Resistor 2K 1% 0.125W
R892	0698-3456	Resistor 287K 1%
R893	0757-0440	Resistor 7.5K 1%
R894,895 (<i>Model specific</i>)		
6571A, 6671A	0699-3103	Resistor 19K 0.05%
6572A, 6672A	0699-2248	Resistor 47.5K 0.05%
6573A, 6673A	0699-2247	Resistor 121K 0.05%
6574A, 6575A, 6674A, 6675A	0699-2198	Resistor 243K 0.05%
R896	0698-3279	Resistor 4.99K 1%
U502	5080-2150	GAL programmed, main
U503	1826-1370	IC 365

Table 5-9. A5 Control Board Replaceable Parts (continued)

Ref. Desig.	Keysight Part No.	Description
ELECTRICAL PARTS		
U504	5080-2250	IC secondary
U505	1826-1369	IC voltage regulator
U507	1826-2187	IC D/A converter
U508	1826-1896	IC linear
U509	1826-2187	IC D/A converter
U510	1826-1896	IC linear
U511	1826-2187	IC D/A converter
U512	1826-1896	IC linear
U513	1826-1370	IC 365
U517	1826-0161	IC 324
U518	1826-1370	IC 365
U600	1820-3199	IC MC74HC4040N
U601	1820-2922	IC MC74HC00N
U602	1820-3081	IC MC74HC74N
U603	1826-2343	IC VRGLTR,SWG
U604	1820-2922	IC MC74HC00N
U605	1826-0065	IC 31 1
U606	1858-0083	Transistor array 14P-DIP
U607	1826-0962	IC 412
U608	1826-0890	IC 358A
U609	1826-1343	IC voltage regulator
U612,615	1826-1409	IC 1013
U617	1826-1895	Precision op amp
U618,621	1826-0962	IC 412
U630	1826-1370	IC 365
VR630	1902-1377	Diode zener 6.19V
VR631	1902-0018	Diode zener IN941
Y501	0410-2109	Crystal oscillator 12.000MHz
MECHANICAL PARTS		
--	0340-1277	Insulator (Y501)
--	1200-0552	Socket IC 40-pin (U504)
--	1200-0639	Socket IC 20-pin (U502)

Table 5-10. A6 output Filter Board Replaceable Parts

Ref. Desig.	Keysight Part No.	Description
ELECTRICAL PARTS		
C901 (<i>Model specific</i>)		
6571A, 6671A	0180-4333	Capacitor 22,000 μ F 16V
6572A, 6672A	0180-4381	Capacitor 20,000 μ F 25V
6573A, 6673A	0180-4390	Capacitor 12,000 μ F 45V
6574A, 6674A	0180-4372	Capacitor 7,000 μ F 75V
6575A, 6675A	0180-4466	Capacitor 2,100 μ F 150V
C902 (<i>Model specific</i>)		
6571A, 6671A	0180-4333	Capacitor 22,000 μ F 16V
6572A-6575A, 6672A-6675A		(Not used)
C903 (<i>Model specific</i>)		
6571A, 6671A	0180-4333	Capacitor 22,000 μ F 16V
6572A, 6672A		(Not used)
6573A, 6673A	0180-4390	Capacitor 12,000pF 45V
6574A, 6674A	0180-4372	Capacitor 7,000 μ F 75V
6575A, 6675A	0180-4466	Capacitor 2,100 μ F 150V
C904 (<i>Model specific</i>)		
6571A, 6671A	0180-4333	Capacitor 22,000 μ F 16V
6572A-6575A, 6672A-6675A	0180-4381	Capacitor 20,000 μ F 25V
C905 (<i>Model specific</i>)		
6571A, 6671A	0180-4333	Capacitor 22,000 μ F 16V
6572A, 6672A	0180-4381	Capacitor 20,000 μ F 25V
6573A, 6673A	0180-4390	Capacitor 12,000 μ F 45V
6574A, 6674A	0180-4372	Capacitor 7,000 μ F 75V
6575A, 6675A	0180-4466	Capacitor 2,100pF 150V
C906 (<i>Model specific</i>)		
6571A, 6671A	0180-4333	Capacitor 22,000 μ F 16V
6572A, 6672A	0180-4381	Capacitor 20,000 μ F 25V
6573A, 6673A	0160-4835	Capacitor 0.17 μ F 10% 50V
6574A, 6674A	0160-4834	Capacitor 0.047 μ F 10%
6575A, 6675A	0160-6804	Capacitor 0.047 μ F 250V
C907,908 (<i>Model specific</i>)		
6571A, 6671A, 6572A, 6672A	0160-4183	Capacitor 1000pF 20%
6573A-6575A, 6673A-6675A	0160-4048	Capacitor 0.22 μ F 20%
C909,910	0160-4413	Capacitor 0.6 μ F 10%
C911,912	0160-4048	Capacitor 0.22 μ F 20%
C913,914	0160-4183	Capacitor 1000pF 20%
C930 (<i>Model specific</i>)		
6571A, 6671A		(Not used)
6572A-6575A, 6672A-6675A	0160-4835	Capacitor 0.1 μ F 10% 50V

Table 5-10. A6 output Filter Board Replaceable Parts (continued)

Ref. Desig.	Keysight Part No.	Description
ELECTRICAL PARTS		
C931 (<i>Model Specific</i>)		
6571A, 6671A, 6572A, 6672A	0160-5468	Capacitor 0.47 μ F 50V
6573A-6575A, 6673A-6675A	0160-6825	Capacitor 0.47 μ F 250V
D900 (<i>Model Specific</i>)		See Main Chassis, Electrical Parts
D901 (<i>Model specific</i>)		(Not used)
6571A-6574A, 6671A-6674A 6575A, 6675A	1906-0404	Output rectifier
D902 (<i>Model specific</i>)		(Not used)
6571A-6574A, 6671A-6674A 6575A, 6675A	1901-1182	Output rectifier
D910,911 (<i>Model specific</i>)		(Not used)
6571A, 6671A 6572A-6575A, 6672A-6675A	1901-1098	Out
F901 (<i>Model specific</i>)		
6571A-6573A, 6671A-6673A	2110-0713	Fuse submin 10AM, 125V
6574A, 6674A	2110-0699	Fuse submin 5AM, 125V
6575A, 6675A	2110-0685	Fuse submin 7AM, 125V
F902 (<i>Model specific</i>)		
6571A, 6571A, 6672A, 6672A	2110-0713	Fuse submin 10AM, 125V
6573A, 6673A		(Not used)
6574A, 6674A	2110-0699	Fuse submin 5AM, 125V
6575A, 6675A		(Not used)
L900 (<i>Model specific</i>)		See Main Chassis, Electrical Parts
L901,902 (<i>Model specific</i>)		
6571A, 6572A, 6671A, 6672A		(Not used)
6573A, 6673A	9170-0061	Coil toroid
6574A, 6674A	9170-1195	Coil toroid
6575A, 6675A	9170-0061	Coil toroid
L90IA (<i>Model specific</i>)		
6571A, 6671A	9170-1040	Coil toroid
6572A, 6573A, 6672A, 6673A		(Not used)
6574A, 6674A	9170-1512	Coil toroid
6575A, 6675A	9170-0061	Coil toroid
L90IB (<i>Model specific</i>)		
6571A, 6671A	9170-1040	Coil toroid
6572A, 6573A, 6672A, 6673A		(Not used)
6574A, 6674A	9170-1512	Coil toroid
6575A, 6675A		(Not used)

Table 5-10. A6 output Filter Board Replaceable Parts (continued)

Ref. Desig.	Keysight Part No.	Description
ELECTRICAL PARTS		
L903,903 (<i>Model specific</i>)		(Not used)
6571A, 6671A, 6572A, 6672A 6573A, 6673A	9170-1518	Coil toroid
6574A, 6674A 6575A, 6675A	9170-1517	(Not used) Coil toroid
L904A,904B (<i>Model specific</i>)		(Not used)
6571A-6573A, 6671A-6673A 6574A, 6674A 6575A, 6675A	9170-1512	Coil toroid (Not used)
Q901 (<i>Model specific</i>)		
6571A, 6671A, 6572A, 6672A	1855-0834	MOSFET power
6573A-6575A, 6673A-6675A	5182-9080	MOSFET power
	1855-1003	MOSFET
Q902 (<i>Model specific</i>)		
6571A, 6671A 6572A, 6672A	5182-9080	(Not used) MOSFET power
6573A-6575A, 6673A-6675A	1855-1003	MOSFET
Q903 (<i>Model specific</i>)		
6571A, 6671A 6572A, 6672A, 6573A-6575A, 6673A-6675A	1855-1003	(Not used) MOSFET
Q910 (<i>Model specific</i>)		
6571A, 6671A 6572A-6575A, 6672A-6675A	1853-0510	(Not used) Transistor PNP
R901-904	0757-0489	Resistor 10 Ω 5% 0.25W
R905,906	0683-0475	Resistor 4.7 Ω 5% 0.25W
R907 (<i>Model specific</i>)		
6571A, 6671A	06671-20001	Shunt current 250A
6572A, 6672A	06672-20001	Shunt current 125A
6573A, 6673A	06673-20001	Shunt current 75A
6574A, 6674A	06674-20001	Shunt current 50A
6575A, 6675A	06675-20001	Shunt current 20A
R908	0683-2755	Resistor 2.7M 5% 0.25W
R909 (<i>Model specific</i>)		
6571A, 6671A	0698-3311	Resistor 51 Ω 5% 2W MO
6572A, 6672A	0698-3630	Resistor 300 Ω 5% 2W Mo
6573A, 6673A	0764-0016	Resistor 1K 5% 2W Mo
6574A, 6674A	0683-2755	Resistor 3K 5% 2W Mo
6575A, 6675A	0698-3646	Resistor 12K 5% 2W Mo

Table 5-10. A6 output Filter Board Replaceable Parts (continued)

Ref. Desig.	Keysight Part No.	Description
ELECTRICAL PARTS		
R910 (<i>Model specific</i>) 6571A, 6671A, 6572A, 6672A 6573A, 6673A 6574A, 6674A 6575A, 6675A	0698-3311	Resistor 51 Ω 5% 2W Mo (Not used)
	0698-3642	Resistor 3K 5% 2W Mo
	0764-0034	Resistor 47K 5% 2W Mo
R911 (<i>Model specific</i>) 6571A, 6671A, 6572A, 6672A, 6573A, 6673A 6574A, 6674A 6575A, 6675A	0699-1060	Resistor 0.05 Ω 1% 3W
	0699-1075	Resistor 0.1 Ω 1% 3W
	0812-0019	Resistor 0.33 Ω 5% 3W PW (Not used)
R912 (<i>Model specific</i>) 6571A, 6671A, 6572A, 6672A, 6573A-6575A, 6673A-6675A	0699-1060	Resistor 0.05 Ω 1% 3W
	0699-1075	Resistor 0.1 Ω 1% 3W
R915 (<i>Model specific</i>) 6571A-6574A, 6671A-6674A 6575A, 6675A	0757-0273	Resistor 3.01K 1%
	0698-3358	Resistor 4.02K 1%
R916	0698-0082	Resistor 464 Ω 1% 0.125W
R917 (<i>Model specific</i>) 6571A, 6671A, 6572A, 6672A 6573A, 6673A 6574A, 6674A 6575A, 6675A		(Not used)
	0764-0016	Resistor 1K 5% 2W Mo (Not used)
	0698-3646	Resistor 12K 5% 2W Mo
R933 (<i>Model specific</i>) 6571A, 6671A 6572A, 6672A 6573A-6575A. 6673A-6675A		(Not used)
	0698-0082	Resistor 464 Ω 1% 0.125W
	0698-0082	(Not used)
R934 (<i>Model specific</i>) 6571A-6574A, 6671A-6674A 6575A, 6675A		(Not used)
	0698-0082	Resistor 464 Ω 1% 0.125W
R935 (<i>Model specific</i>) 6571A-6573A, 6671A-6673A 6574A, 6674A 6575A, 6675A		(Not used)
	0757-0290	Resistor 6.19K 1% (Not used)
R936 (<i>Model specific</i>) 6571A, 6671A 6572A-6575A, 6672A-6675A		(Not used)
	0757-0451	Resistor 24.3K 1%

Table 5-10. A6 output Filter Board Replaceable Parts (continued)

Ref. Desig.	Keysight Part No.	Description
ELECTRICAL PARTS		
R937 (<i>Model specific</i>)		(Not used)
6571A, 6671A		(Not used)
6572A, 6672A	0698-4416	Resistor 169 Ω 1% 0.125W
6573A, 6673A		
6574A, 6674A	0757-0274	Resistor 1.21K 1%
6575A, 6675A	0698-4416	Resistor 169 Ω 1% 0.125W
R938 (<i>Model specific</i>)		
6571A, 6671A	8159-0005	Resistor 0 Ω
6572A-6575A,		(Not used)
6672A-6675A		
T900 (<i>Model specific</i>)		See Main Chassis, Electrical Parts
6571A, 6671A	9100-4909	Transformer power
6572A, 6672A	9100-4946	Transformer power
6573A, 6673A	9100-4945	Transformer power
6574A, 6674A	9100-4910	Transformer power
6575A, 6675A	9100-4944	Transformer power
U901 (<i>Model specific</i>)		
6571A, 6671A		(Not used)
6572A-6575A,	1826-0890	IC LN358A
6672A-6675A		
VR901	1902-0960	Diode zener 12V 5%
VR902 (<i>Model specific</i>)		
6571A, 6671A		(Not used)
6572A, 6672A	1902-0960	Diode zener 12V 5%
6573A-6575A,		(Not used)
6673A-6675A		
W900,901	1251-4180	Connector (R902, \pm ISEN)
W910,911 (<i>Model specific</i>)		
6571A, 6671A,		(Not used)
6572A, 6672A		
6573A, 6673A	5080-2177	
6574A, 6575A,		(Not used)
6674A, 6675A		
W912,913 (<i>Model specific</i>)		
6571A-6574A,		(Not used)
6671A-6674A		
6575A, 6675A	5080-2177	
W914 (<i>Model specific</i>)		
6571A, 6671A,		(Not used)
6572A, 6672A		
6573A, 6673A	5080-2177	
6574A, 6575A,		(Not used)
6674A, 6675A		

Table 5-10. A6 output Filter Board Replaceable Parts (continued)

Ref. Desig.	Keysight Part No.	Description
ELECTRICAL PARTS		
W915 (<i>Model specific</i>)		
6571A, 6671A,		(Not used)
6572A, 6672A		
6573A, 6673A	5080-2177	
6574A, 6674A	(Not used)	
6575A, 6675A	5080-2177	
W916,917 (<i>Model specific</i>)		
6571A-6574A,		(Not used)
6671A-6674A		
6575A, 6675A	5080-2177	
W918-W921 (<i>Model specific</i>)		
6571A, 6671A,		(Not used)
6572A, 6672A		
6573A, 6673A	5080-2177	
6574A, 6674A		(Not used)
6575A, 6675A	5080-2177	
MECHANICAL PARTS		
	1251-4211	Connector (Q901)
	1340-1507	Insulator (Q901, 902 and 903)
	0515-1253	Screw cap M 8X1.25 (shunt to A6 bd)

Table 5-11. A7 Snubber Board Replaceable Parts

Ref. Desig.	Keysight Part No.	Description
ELECTRICAL PARTS		
C901 (<i>Model specific</i>) 6571A-6574A, 6671A-6674A 6575A, 6675A	0764-0013	(Not used) Capacitor 2200pF 1KV
C990 991 (<i>Model specific</i>) 6571A, 6671A 6572A, 6672A 6573A, 6673A 6574A, 6575A, 6674A, 6675A	0160-5927 0160-6896 0160-6030 0160-6838	Capacitor 0.022 μ F 400V Capacitor 0.015 μ F 400V Capacitor 0.01 μ F 400V Capacitor 2200pF 1KV
R990,991 (<i>Model specific</i>) 6571A, 6671A, 572A, 6672A 6572A, 6672A, 6573A, 6673A 6574A, 6575A, 6674A, 6675A	0698-3601 0698-3614 0764-0013	Resistor 10 Ω 5% 2W MO Resistor 43 Ω 5% 2W MO Resistor 56 Ω 5% 2W MO
R992-R995 (<i>Model specific</i>) 6571A, 6671A 6572A, 6672A, 6573A, 6673A 6574A, 6575A, 6674A, 6675A	0698-3614 0764-0013	(Not used) Resistor 43 Ω 5% 2W MO Resistor 56 Ω 5% 2W MO
R996-R999 (<i>Model specific</i>) 6571A-6574A, 6671A-6674A 6575A 6675A	0698-3635	(Not used) Resistor 680 Ω 5% 2W MO

Diagrams

Introduction

This chapter contains drawings and diagrams for troubleshooting and maintaining Series 657xA and 667xA Power Supplies. Unless otherwise specified, a drawing or diagram applies to all models of the series. Wiring connections to external equipment are shown in the Power Supply Operating Manual.

Chapter Organization

Table 6-1 summarizes the contents of this chapter.

Table 6-1. Summary of Chapter Contents

Function	Description	See
Interconnections	Drawing identifying each circuit board, the cables between boards, and schematic diagram for each board.	Figure 6-2
Schematics	Show test points, signal mnemonics, component-location grid coordinates, and specific notes. General notes applicable to all schematics are given in Table 6-4. A1 Front Panel Board. A2 GPIB Board (Used in 667xA Series only). A2 Isolator Board (Used in 657xA Series only). A3 FET Board. A4 Input AC Power Board. A5 Control Board (3 sheets) Secondary Interface and CV/CC Readback DACS. CV/CC Control Circuits. Switching, Down Programmer Control, OV Monitor. Keysight 6571A/72A, 6671A/72A A6 Output Filter Board & A7 Snubber Board. Keysight 6573A/74A, 6673A/74A A6 Output Filter Board & A7 Snubber Board. Keysight 6575A and 6675A A6 Output Filter Board & A7 Snubber Board .	
Signal Names	Table of signal name mnemonics	Table 6-2
Parts Location	A drawing that shows the location of components on a circuit board is located next to the above circuit board schematic diagram. A drawing showing location of each circuit board in the chassis is in Chapter 3.	Figure 3-19
Test Points	Description of each test point. Location of each test point is shown on the the appropriate schematic and its associated parts location drawing.	Table 6-3

Table 6-2. Signal Name Mnemonics

Mnemonic	Description	Mnemonic	Description
A(0)-A(15)	Address lines	MSRQ	Microprocessor service request
AD (0)-AD(7)	Address bus	NDAC	Not data accepted (GPIB)
AMB_SENSE	Ambient temperature sense	NEG_IMON	Negative current monitor
ANA(0)-ANA(7)	Analog signal readback bus	NRFD	Not ready or data (GPIB)
ATN	Attention (GPIB)	OV	Overvoltage
BIAS_OK	±15V bias supplies have stabilized	OV_CLR	Overvoltage clear
BOVPROG	Buffered OV programming	OVCMP	Overvoltage comparator
BSTX	Buffered secondary transmit	OVP_BIAS	Overvoltage protection bias
cc	Constant current status	OVPROG	Overvoltage programming
CCPROG	Constant current programming	OVSCR	Overvoltage SCR (crowbar)
cv	Constant voltage status	PCLR	Primary power clear
CVPROG	Constant voltage programming	PREF	Primary reference voltage (2.53V)
D(0)_D(7)	Data lines	PREF_2	Primary reference voltage (1.0V)
D101-D108	Data lines (GPIB)	PREN	Primary remote enable
DAV	Data valid (GPIB)	PRX	Primary receive serial data
DFI	Discrete fault indicator	PTX	Primary transmit serial data
DFI-EN	Discrete fault indicator enable	PWM_EN	Pulse width modulator enable
DPS	Downprogramming shunt	RAM	Random access memory
DN_PGM	Down programming	RDY	Ready
DRIVE_A/B	FET drive signals	REN	Remote enable
EOI	End or identify (GPIB)	RI	Remote inhibit
FAC_CAL	Factory calibration	ROM	Read only memory
FAN_PWM	Fan pulse width modulation	SPCLR	Secondary power clear
FPRX	Front panel receive serial data	RX	Receive serial data
FPTX	Front panel transmit serial data	RxD	Receive serial data
FS	Fast sense	SA	Signature analysis
HSRQ	GPIB service request	SRQ	Service request (GPIB)
IFC	Interface clear (GPIB)	SRX	Secondary receive serial data
IMON	Current monitor	STX	Secondary transmit serial data
INH_CAL	Inhibit calibration	TxD	Transmit serial data
IP	External current programming	UART	Universal asynchronous Receive/transmit
IPROG	Current programming	VMON	Voltage monitor
ISEN	Current sense	vos	Voltage offset
ISRQ	Interface service request	VPROG	Voltage programming
KO(0)-KO(5)	Keypad output data bus	WR	Write
KI(0)-KI(5)	Keypad input data bus		

Table 6-3. Troubleshooting Test Points

TEST POINT No. & Loc.	Signal Tested	Measurement and Conditions
A2 GPIB BOARD (667xA Series Only)		
1 J106-4 2 U101-1 3 U101-6 4 U101-8 5 U110-3 6 U111-6 7 U119-4 8 U119-18	Primary/chassis ground + 5V primary bias PCLR PCLR* STX SRX FPRX FPTX	Connect meter or scope common here. Then make measurements at test points 2 through 8 . + 5V ± 0.2V Goes high for approximately 40 ms at power on, then goes low. Held low for approximately 40 ms at power on, then goes high. Primary transmit to secondary serial data line. Toggles between 0 and +5V. Primary receive from secondary serial data line. Toggles between 0 and +5V. Primary receive from front panel serial data line. Toggles between 0 and +5V. Primary transmit to front panel serial data line. Toggles between 0 and +5V.
A2 Isolator BOARD (657xA Series Only)		
1 -C803 2 +U805-3 3 J800-2 4 J801-2 5 J801-4 6 J801-3 7 J800-4 8 J800-3	Primary/chassis ground + 5V primary bias SPCLR PCLR* (also called RESET*) TxD RxD Rx BSTx	+ 5V ± 0.2V Held low for approximately 40 ms at power on, then goes high. Held low for approximately 40 ms at power on, then goes high. Primary transmit to secondary serial data line. Toggles between 0 and 5V. Primary receive from secondary serial data line. Toggles between 0 and 5V. Primary receive from front panel serial data line. Toggles between 0 and 5V. Primary transmit to front panel serial data line. Toggles between 0 and 5V.

Table 6-3. Troubleshooting Test Points (continued)

TEST POINT No. & Loc.	Signal Tested	Measurement and Conditions
A4 AC Input Board		
<p> 9 -C307 10 R317 11 +C352 12 -C315 13 R333 14 R331 15 +C353 16 R330 17 +C354 18 U310-6 19 U308-6 20 U308-7 21 U308-1 22 U308-5 23 U311-7 24 D317 25 U311-2 </p>	<p> +15 Vp primary bias common +15 Vp primary bias +26V Secondary common +5V secondary bias +15V_s secondary bias +26V -15V_s secondary bias -25V RELAY ON* RESET BIAS OK PREF RESET* FAN DETECT -25V FAN_PWN </p>	<p> Connect meter or scope common here. Then make measurements at test points 10 through 11 . +15 ± 0.9V +24.4V to +28.6V Move meter or scope common here. Then make measurements at test points 13 through 23 . +5 ± 0.2V +15 ± 0.9V +24.4V to +28.6V -15 ± 0.9V -22.5V to -27.5V 0V 0V +5V +2.5V Held low for approximately 50 ms at power-on, then goes high. +3V +3V +0.6V </p>
A3 FET Board		
	<p> Note: Test points 26 through 35 are on the A3 FET Board. Troubleshooting procedures at these points are given under Dynamic Troubleshooting section of the FET Troubleshooting Chart (Table 3-4). </p>	

Table 6-3. Troubleshooting Test Points (continued)

TEST POINT No. & Loc.	Signal Tested	Measurement and Conditions						
A5 Control Board								
36 +C558 37 U505-6 38 U517-7 39 U508-6 40 U510-6	Secondary common (Sheet 1) CC/CC DACs reference (Sheet 1) Readback DAC reference (Sheet 1) CVPROG (Sheets 1,2) CVPROG (Sheets 1,2)	Connect meter or scope common here. Then make measurements at test points 37 through 61 and 63 through 69 $+10 \pm 0.05V$ $-11.6 \pm 0.1V$ Approximately -4.6V (with voltage programmed 1/2 of full scale) Approximately -4.1V (with voltage programmed 1/2 of full scale)						
Note: Measurements at test points 41 through 69 where taken under the following conditions: 1. Programming <ol style="list-style-type: none"> a. Programming Voltage = 1/2 scale b. Current = 1/2 scale c. OV = full scale 2. First measurement in CV mode with no load. 3. Second measurement in CC mode with output shorted.								
41 U615-1 42 U615-7 43 U630-2	VMON (Sheet 2) CV CONTROL (Sheet 2) CV* (Sheet 2)	<table border="0"> <tr> <td>CV mode = +4.6V</td> <td>CC mode = 0V</td> </tr> <tr> <td>CV mode = +2.4V</td> <td>CC mode = 12V</td> </tr> <tr> <td>CV mode = 0V</td> <td>CC mode = 5V</td> </tr> </table>	CV mode = +4.6V	CC mode = 0V	CV mode = +2.4V	CC mode = 12V	CV mode = 0V	CC mode = 5V
CV mode = +4.6V	CC mode = 0V							
CV mode = +2.4V	CC mode = 12V							
CV mode = 0V	CC mode = 5V							
44 U618-1	CC CLAMP AMP output (Sheet 2)	<table border="0"> <tr> <td>CV mode = +2.2V</td> <td>CC mode = +2.2V</td> </tr> </table>	CV mode = +2.2V	CC mode = +2.2V				
CV mode = +2.2V	CC mode = +2.2V							
45 U617-6	1ST I AMP output (Sheet 2)	<table border="0"> <tr> <td>CV mode = 0V</td> <td>CC mode = -0.6V</td> </tr> </table>	CV mode = 0V	CC mode = -0.6V				
CV mode = 0V	CC mode = -0.6V							
46 U612-7	2ND I AMP output (Sheet 2)	<table border="0"> <tr> <td>CV mode = 0V</td> <td>CC mode = +4.5V</td> </tr> </table>	CV mode = 0V	CC mode = +4.5V				
CV mode = 0V	CC mode = +4.5V							
47 U612-1	CC CONTROL (Sheet 2)	<table border="0"> <tr> <td>CV mode = +15V</td> <td>CC mode = +0.4V</td> </tr> </table>	CV mode = +15V	CC mode = +0.4V				
CV mode = +15V	CC mode = +0.4V							
48 U630-3	CC* (Sheet 2)	<table border="0"> <tr> <td>CV mode = +5V</td> <td>CC mode = 0V</td> </tr> </table>	CV mode = +5V	CC mode = 0V				
CV mode = +5V	CC mode = 0V							
49 U621_1	FAST SENSE AMP (Sheet 3)	<table border="0"> <tr> <td>CV mode = -4V</td> <td>CC mode = 0V</td> </tr> </table>	CV mode = -4V	CC mode = 0V				
CV mode = -4V	CC mode = 0V							
50 U607-7	RAMP GEN (Sheet 3)	See Figure 6-1						
51 U607-1	RAMP GEN (Sheet 3)	See Figure 6-1						
52 U602-9	DIVIDER output (Sheet 3)	See Figure 6-1						
53 U605-3	SUMMING POINT (Sheet 3)	See Figure 6-1						
54 U602-6	DEADTIME LATCH (Sheet 3)	See Figure 6-1						

Table 6-3. Troubleshooting Test Points (continued)

TEST POINT No. & Loc.	Signal Tested	Measurement and Conditions	
55 U605-7	SUMMING COMPARATOR (Sheet 3)	See Figure 6-1	
56 U600-10	DIVIDER CLOCK (Sheet 3)	See Figure 6-1	
57 U601-6	DIVIDER RESET (Sheet 3)	See Figure 6-1	
58 U601-3	ON LATCH CLOCK (Sheet 3)	See Figure 6-1	
59 U604-3	ON LATCH (Sheet 3)	See Figure 6-1	
60 U603-3	PWM_EN (Sheet 3)	Held high for approximately 12 seconds at power-on, then goes low.	
61 U603-13	VOS (Sheet 3)	+5 ± 0.2V	
NOTE: Temporarily move both scope leads to J503 for TP 62 .			
62 J503-1,2	DRV A, DRV B (Sheet 3)	See Figure 6-1	
63 U630-15	OVCMP (Sheet 3)	+5V	
64 U517-14	OVREF (Sheets 1,3)	+4.2V	
65 Q602,C	DP CONTROL (Sheet 3)	CV Mode -	CC Mode -0.14V
66 U608-7	DP CONTROL (Sheet 3)	CV Mode +13V	CC Mode 0V
67 U630-11	PREF_2 (Sheets 1,3)	+1V	
68 U630-12	DN PGM (Sheets 1,3)	0V	
69 D660-AN	DP_TST (Sheet 3)	0V	
70 U630-10	OV COMPARATOR (Sheet 3)	CV Mode +1.5V	CC Mode +3.25V

General Schematic Notes

The following table lists summary information about notes appearing in schematic diagrams.

Table 6-4. General Schematic Notes

1. All resistors are in ohms $\pm 1\%$, 1/8W, unless otherwise specified.
2. All capacitors are in microfarads unless otherwise specified.
3. Signal lines that are terminated by flags continue on other sheets, and may also go to other locations on the same sheet.
Example: CVPROG (SH.2 8C); "SH.2 8C" indicates the sheet number and the coordinates on that sheet where the CVPROG signal line goes.
4. Unterminated signal lines go to a least one other location on the same sheet.
5. Unless otherwise noted, bias connections to integrated-circuit packages are as follows:

	Common	+ 5V
14-pin packages	pin 7	pin 14
16-pin packages	pin 8	pin 16
20-pin packages	pin 10	pin 20

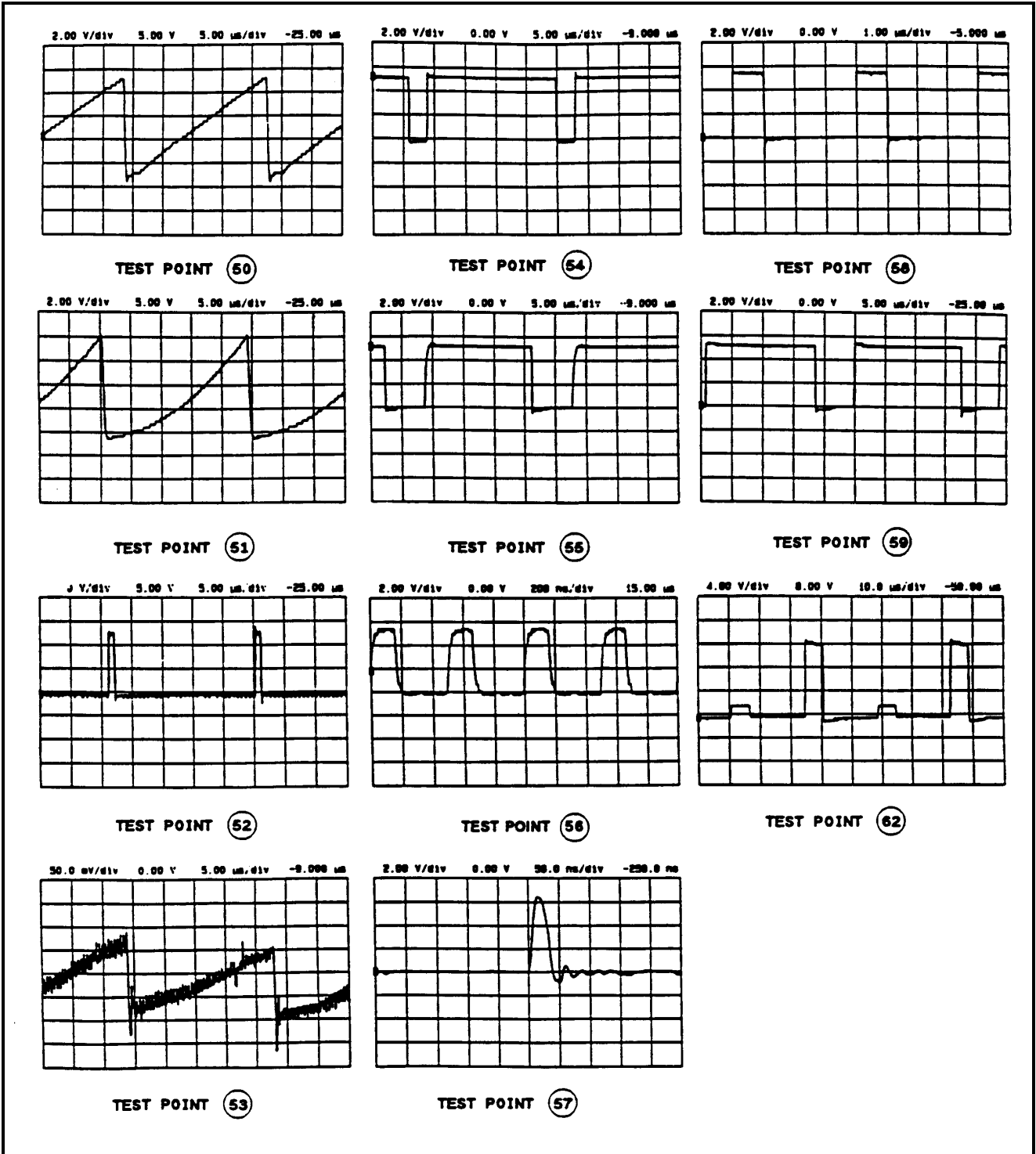

Figure 6-1. Test Point Waveforms for Table 6-3

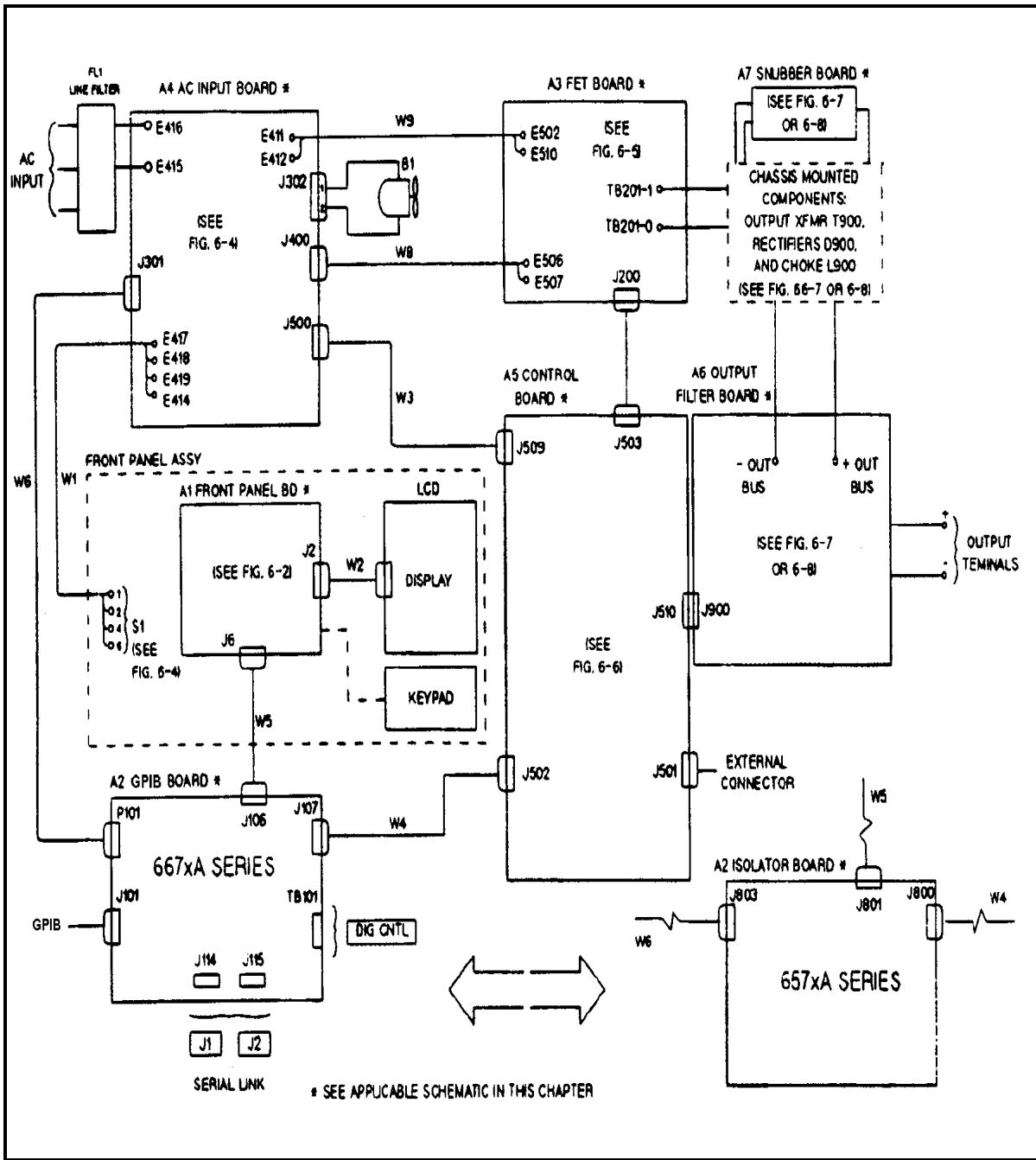

Figure 6-2. Circuit Board Cabling Diagram

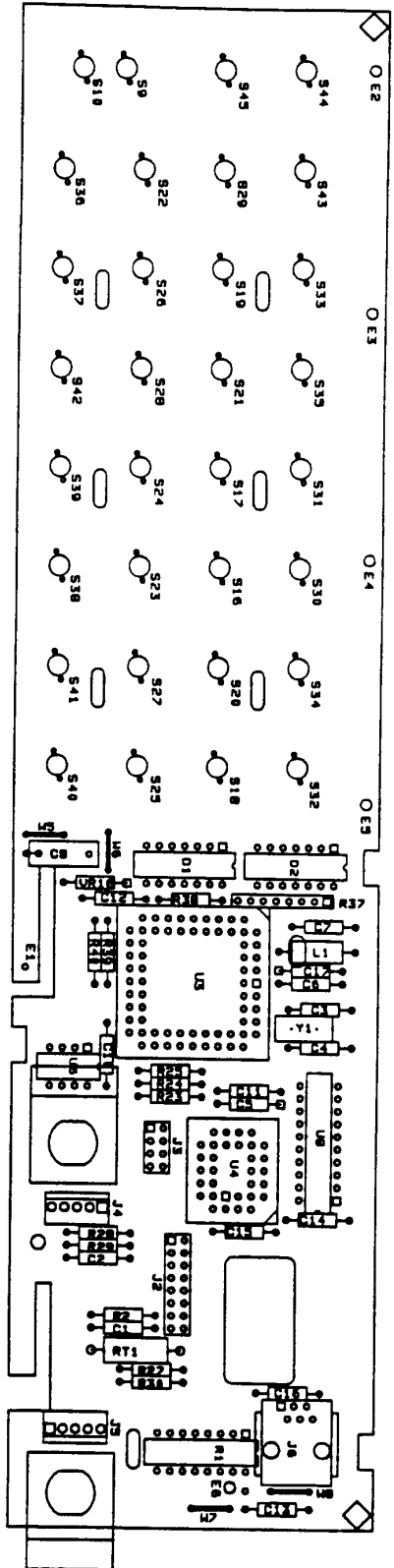
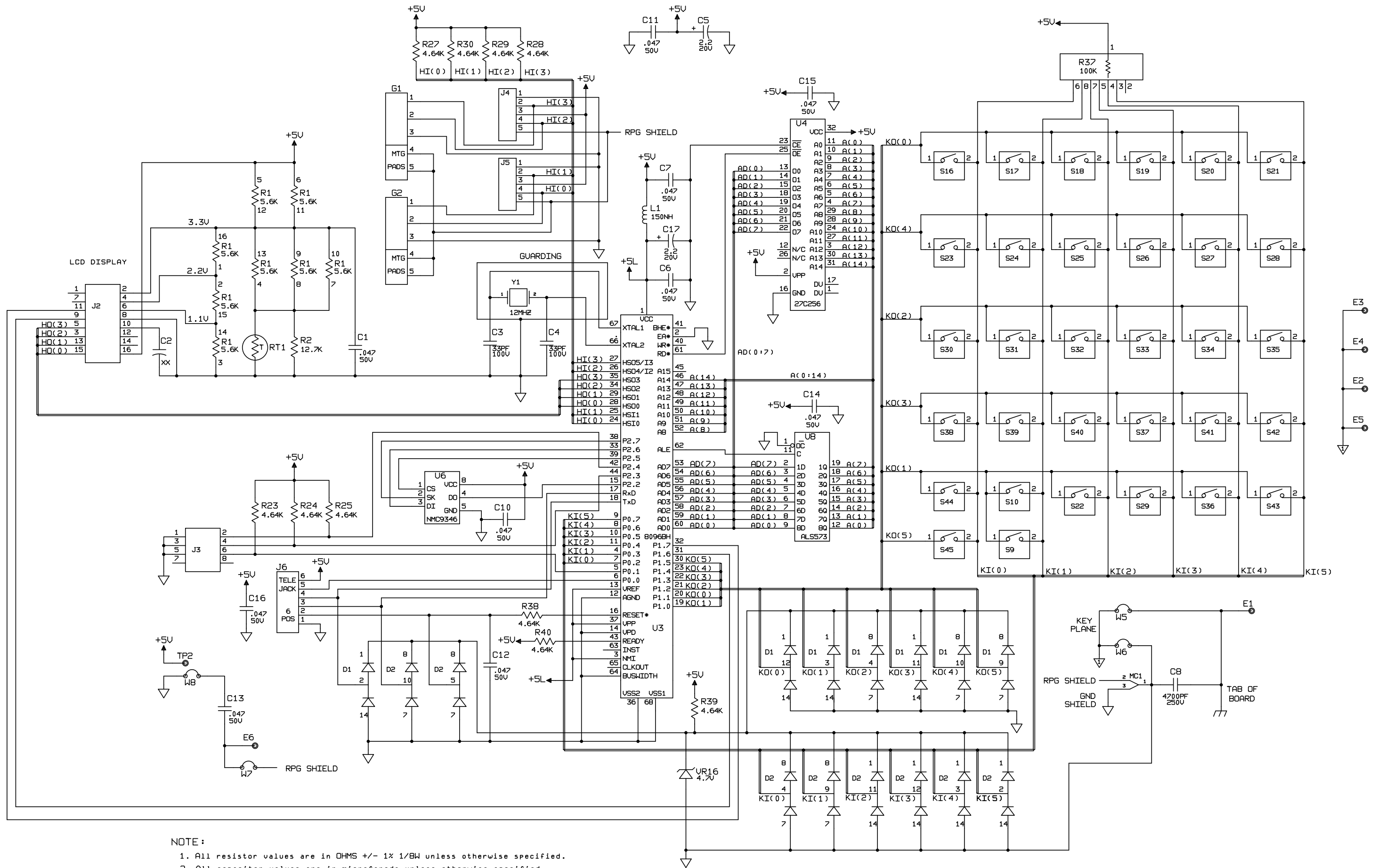

Figure 6-3. A1 Front Panel Board, Component Location Diagram



NOTE :

1. All resistor values are in OHMS +/- 1% 1/BW unless otherwise specified.
2. All capacitor values are in microfarads unless otherwise specified.

Figure 6-4. A1 Front Panel Board Schematic Diagram

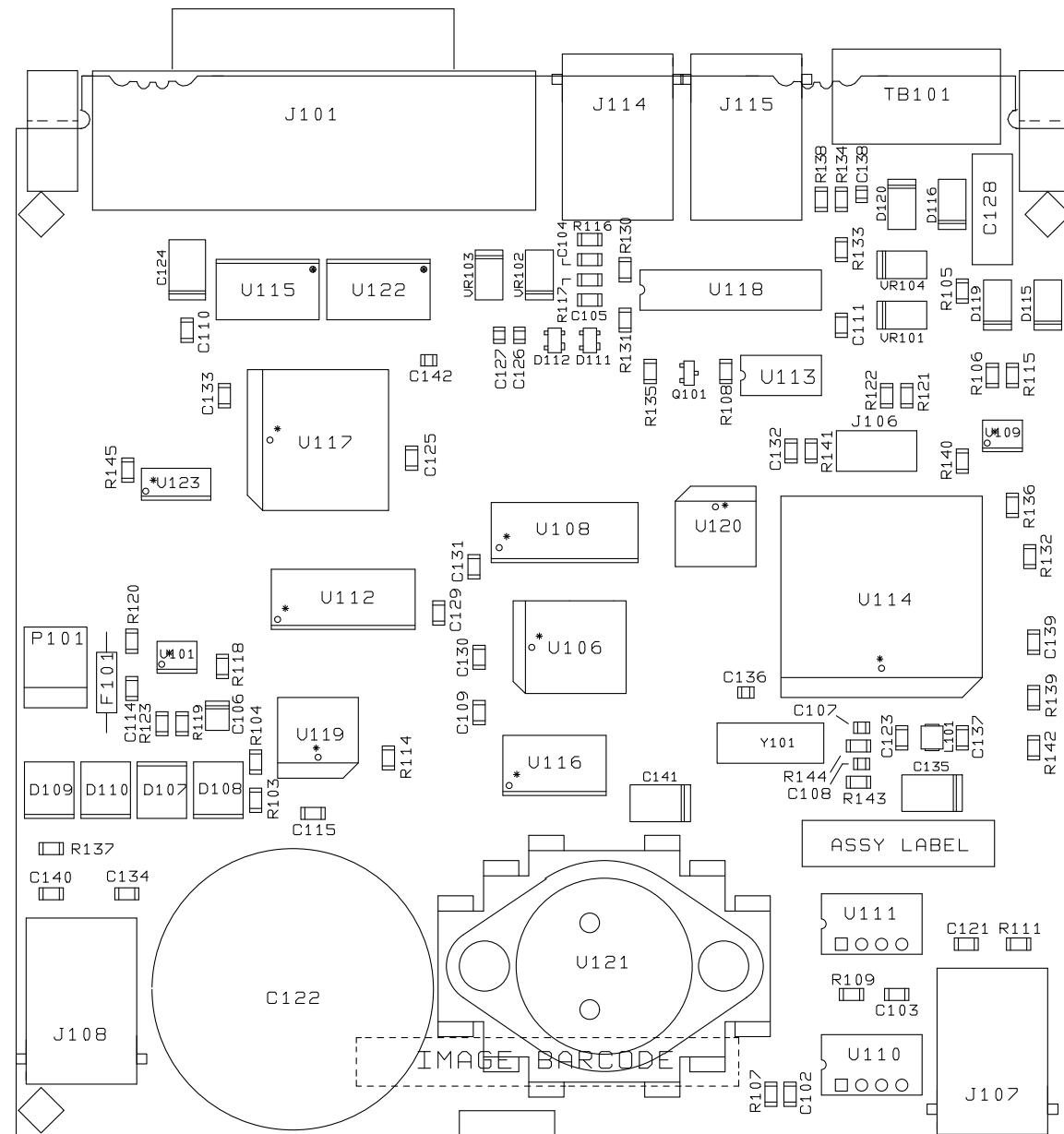

Figure 6-5. A2 GPIB Board Assembly Diagram (667xA only)

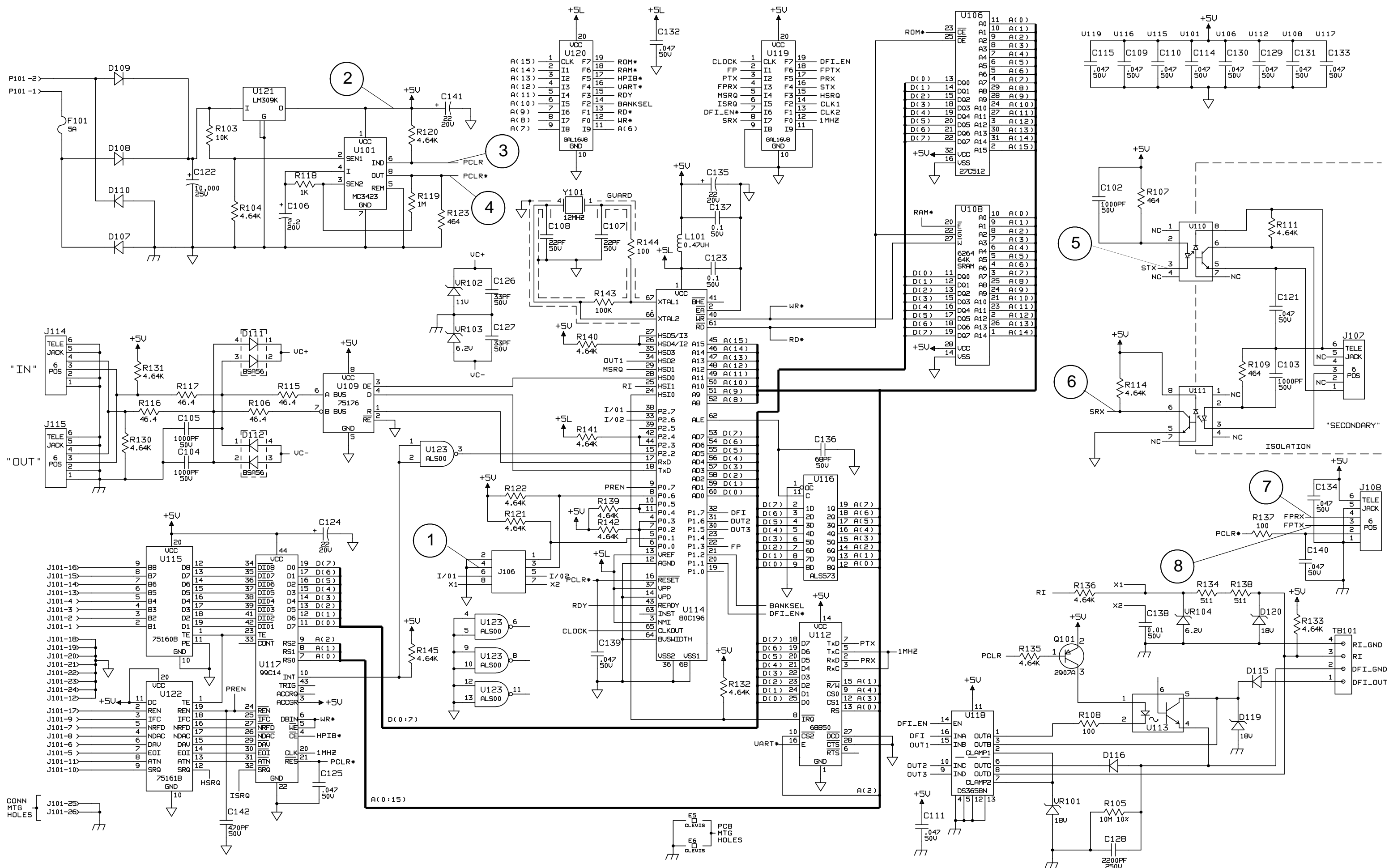
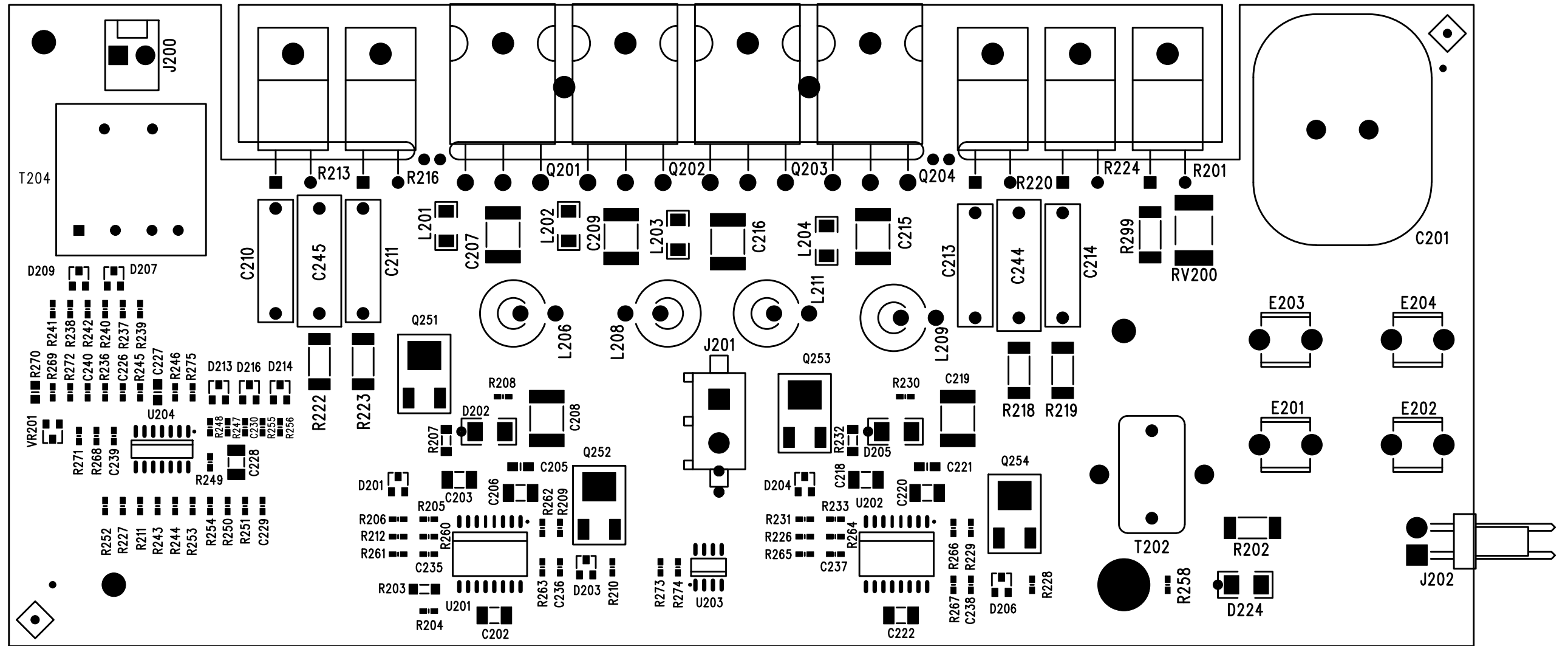

Figure 6-6. A2 GPIB Board Schematic Diagram (667xA only)



LAYER 1 - COMPONENT SIDE

Figure 6-7. A3 FET Board Assembly Diagram and Test Point Locations

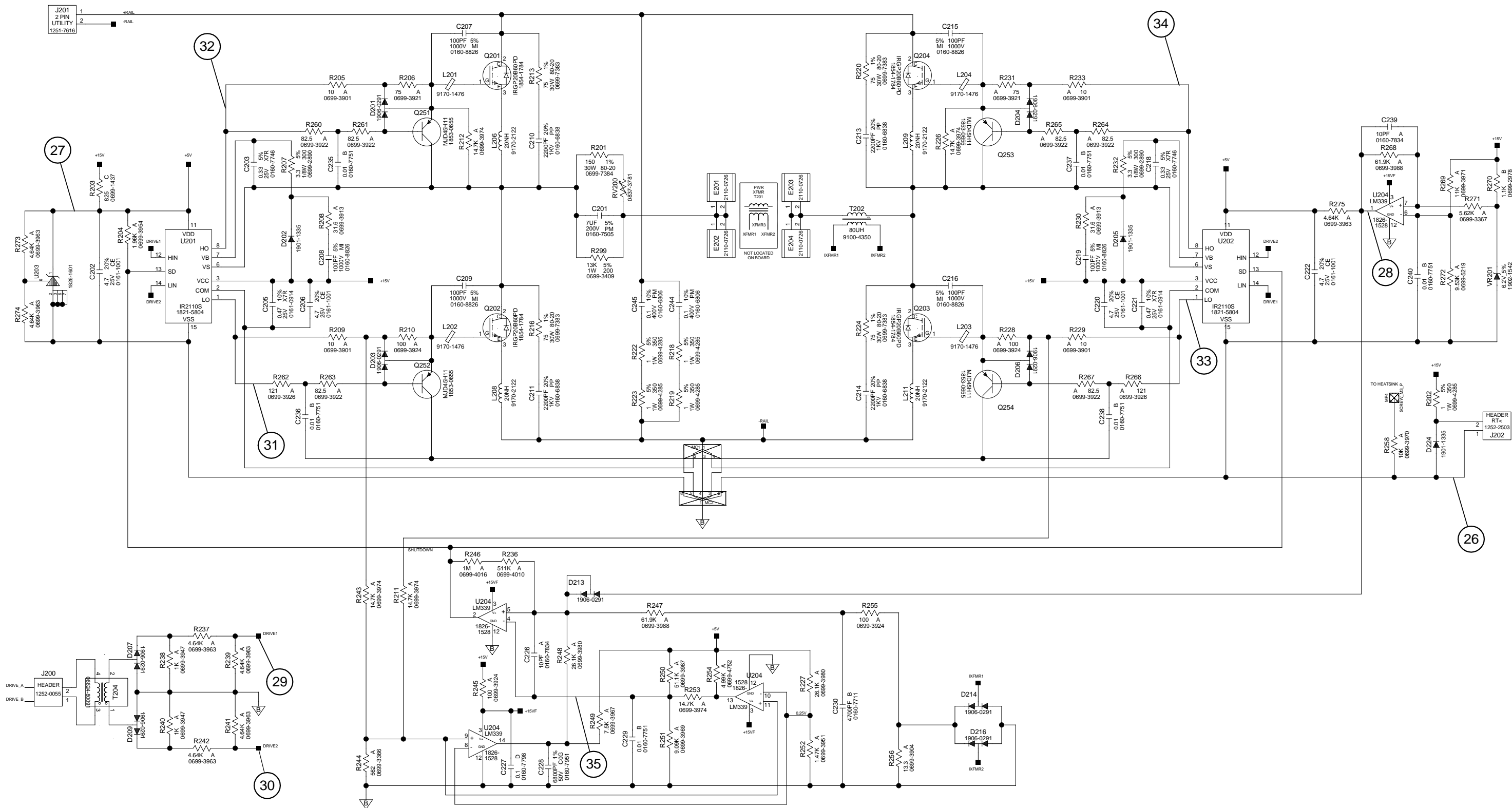

Figure 6-8. A3 FET Board Schematic Diagram

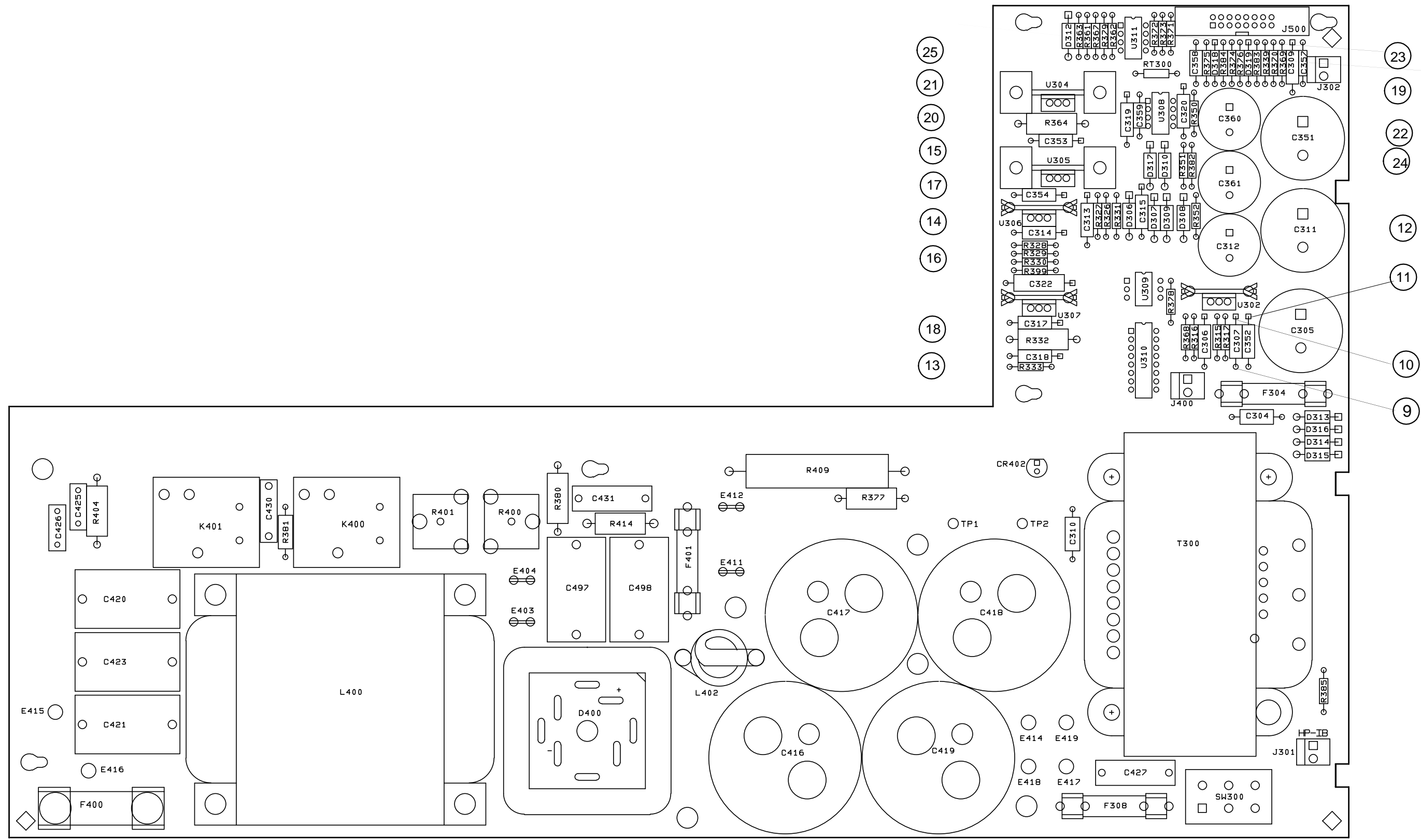

Figure 6-9. A4 AC Input Board Assembly Diagram and Test Point Locations

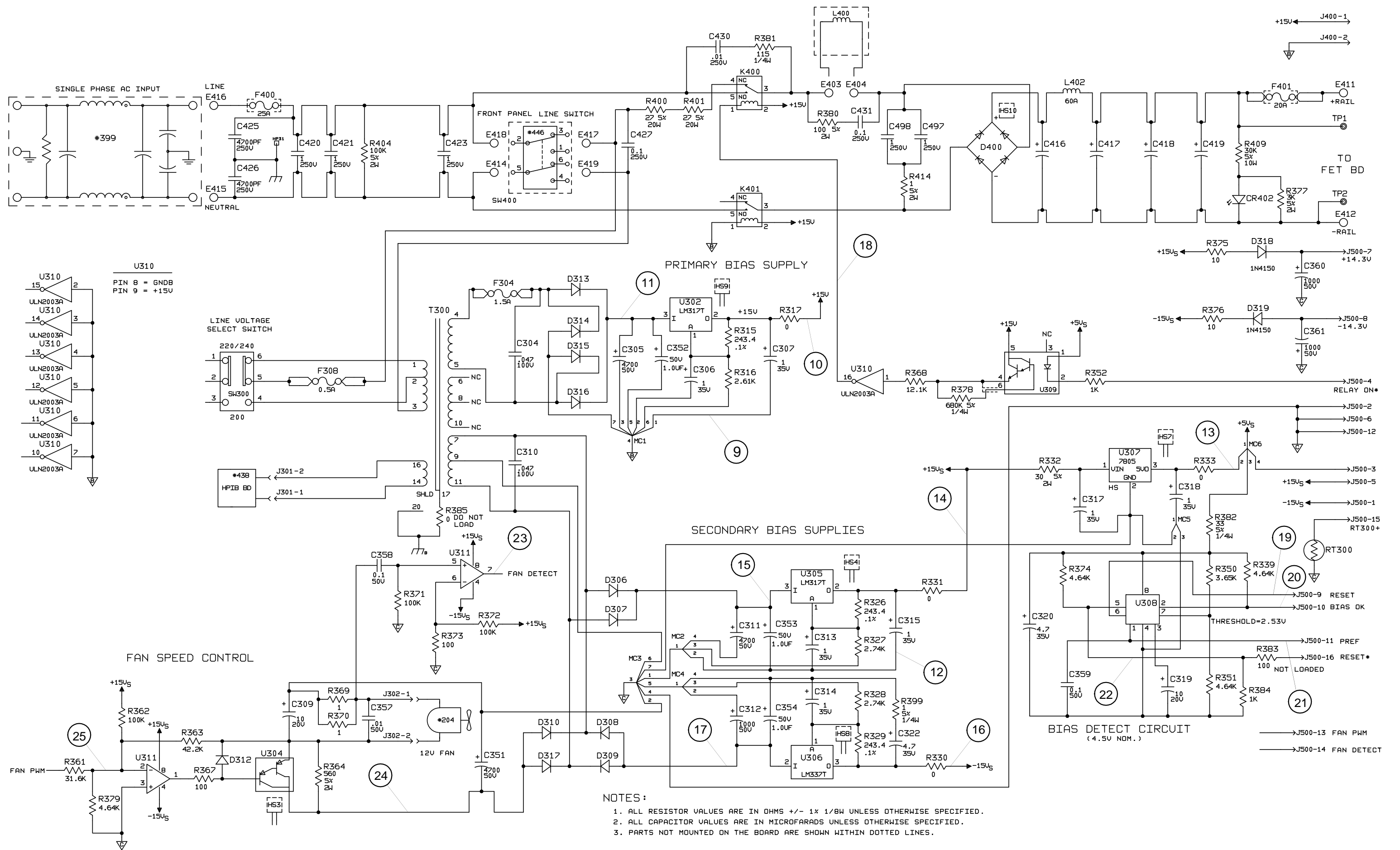

Figure 6-10. A4 AC Input Board Schematic Diagram

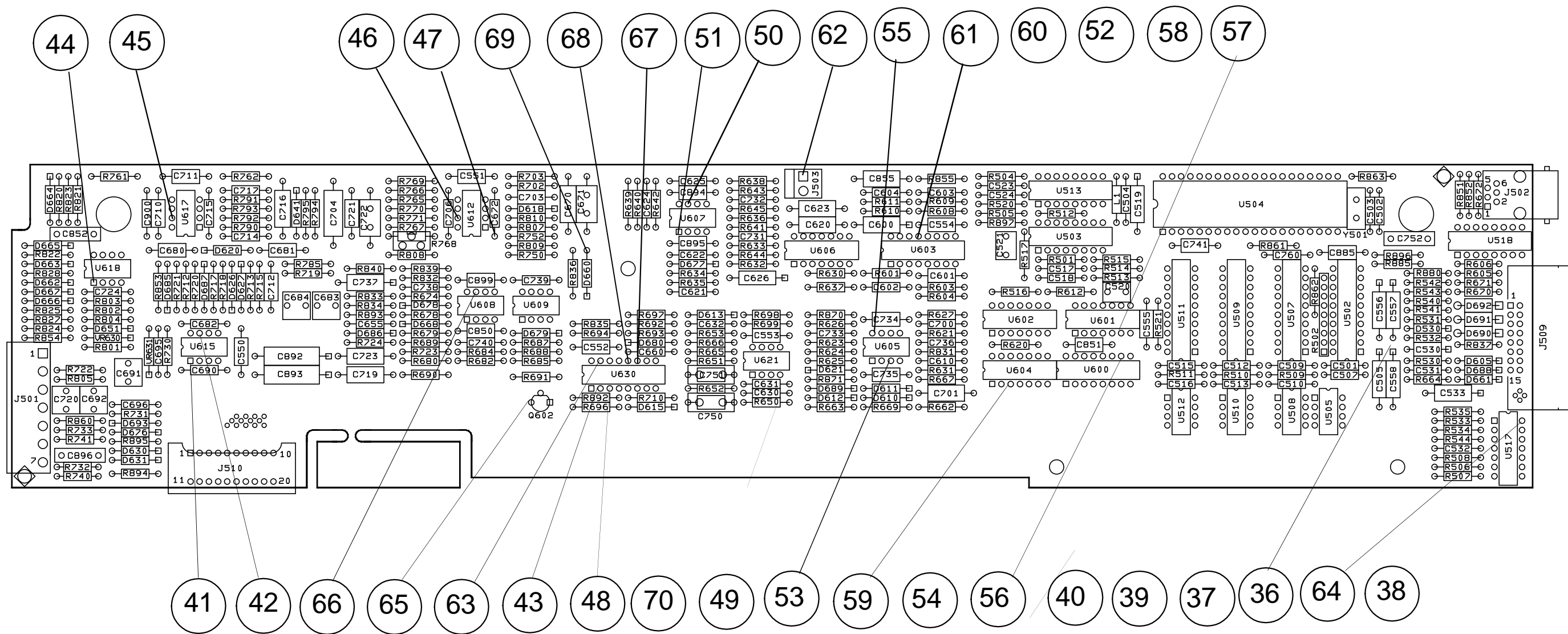

Figure 6-11. A5 Control Board Assembly Diagram and Test Point Locations

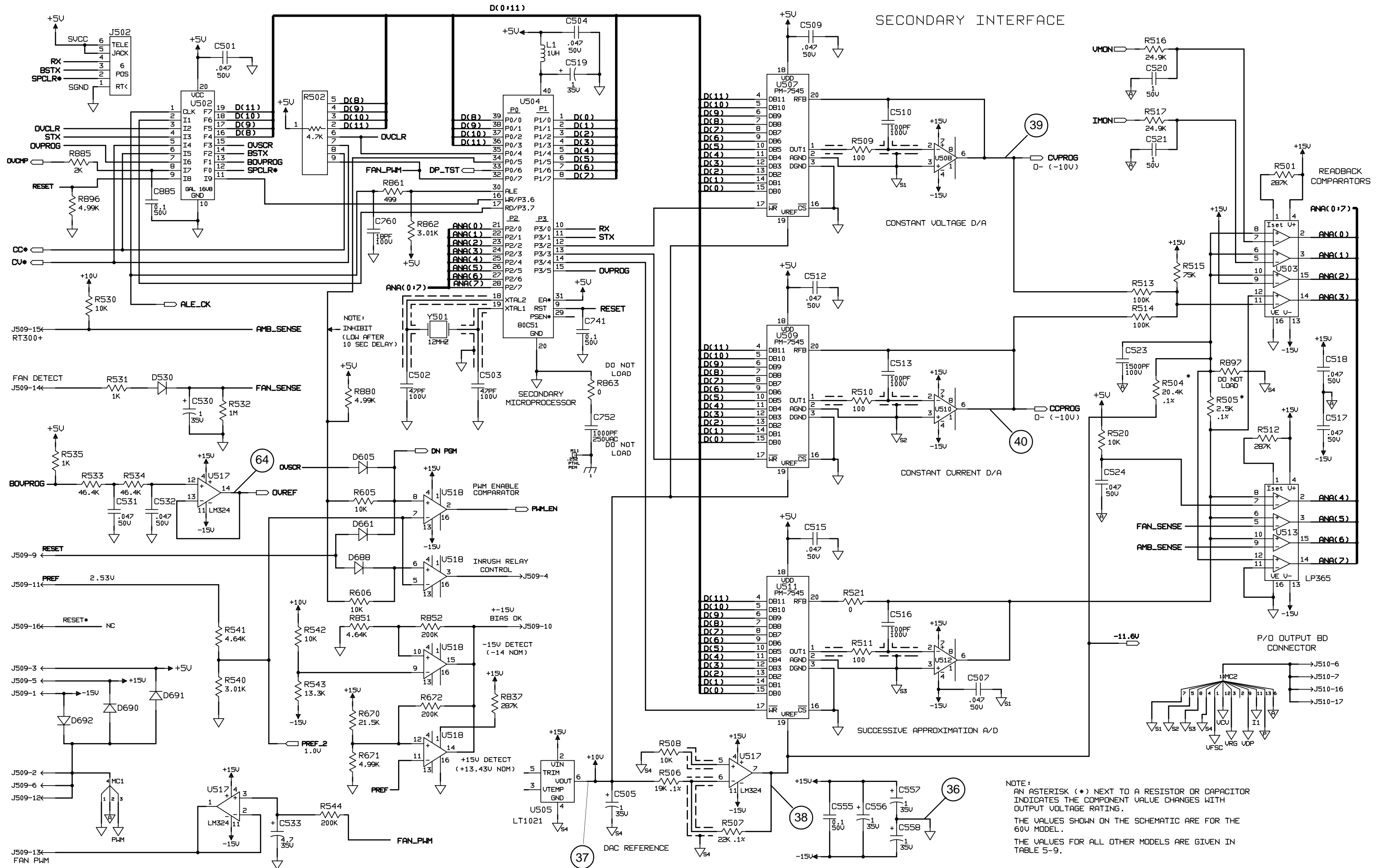

Figure 6-12. A5 Board Sec. & CV/CC Readback DACs Schematic sheet 1

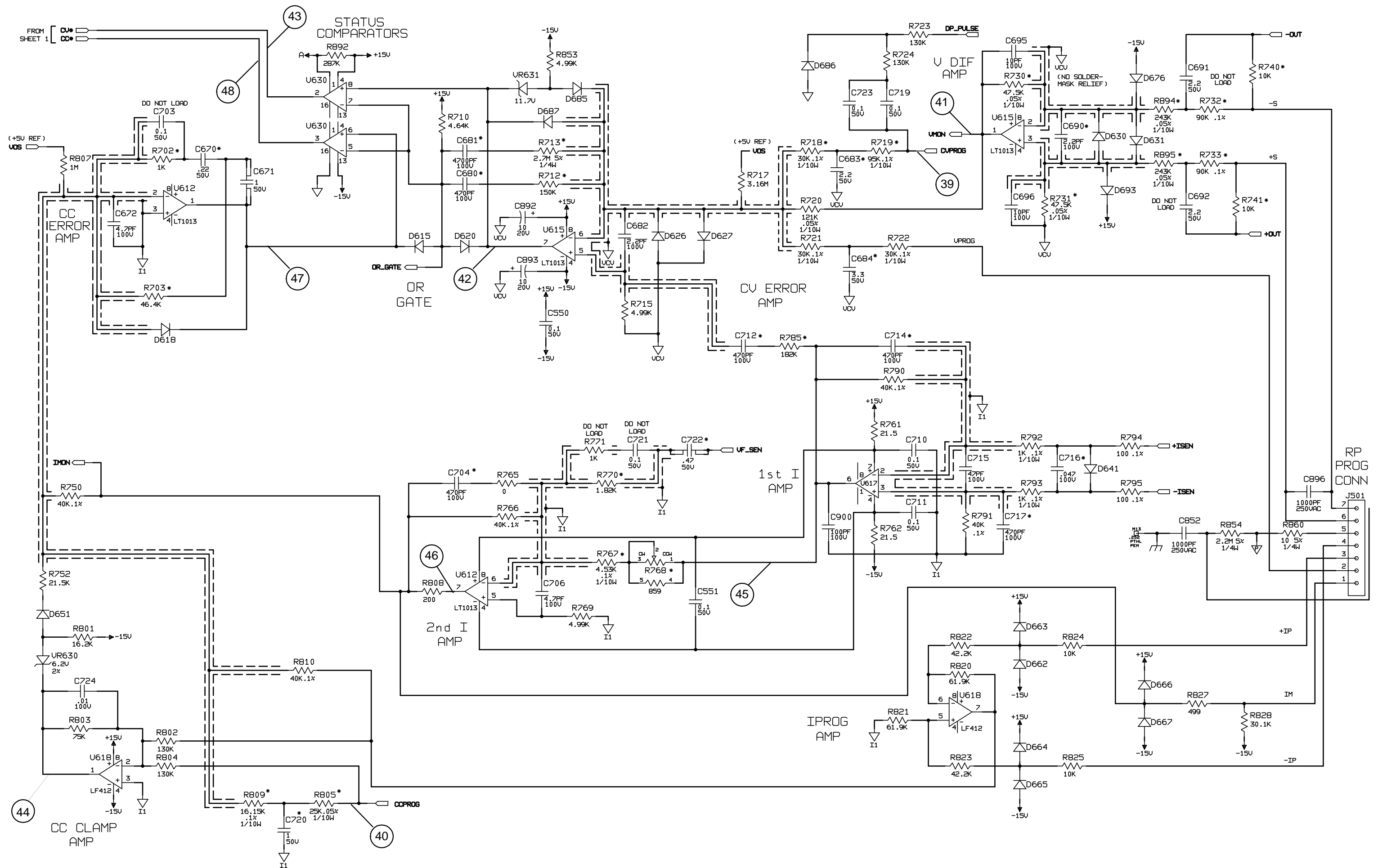

Figure 6-12. A5 Board CV/CC Control Circuits Schematic sheet 2

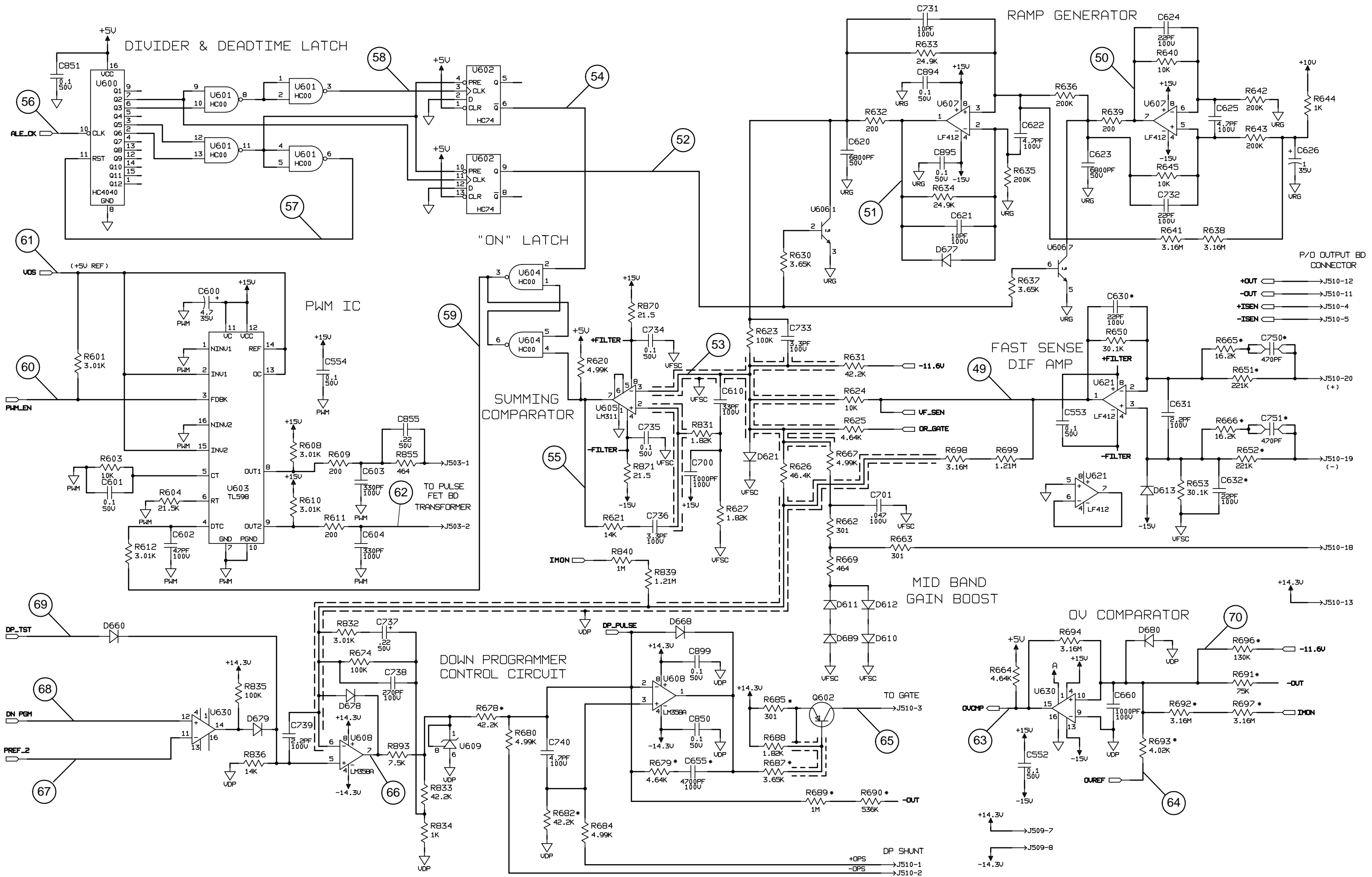

Figure 6-12. A5 Board Switch/Downprog. & OV Monitor Schematic sheet 3

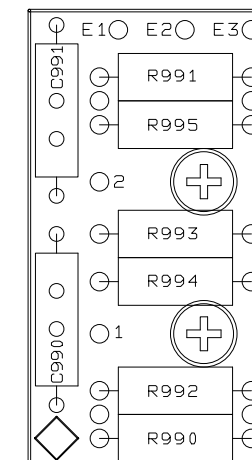
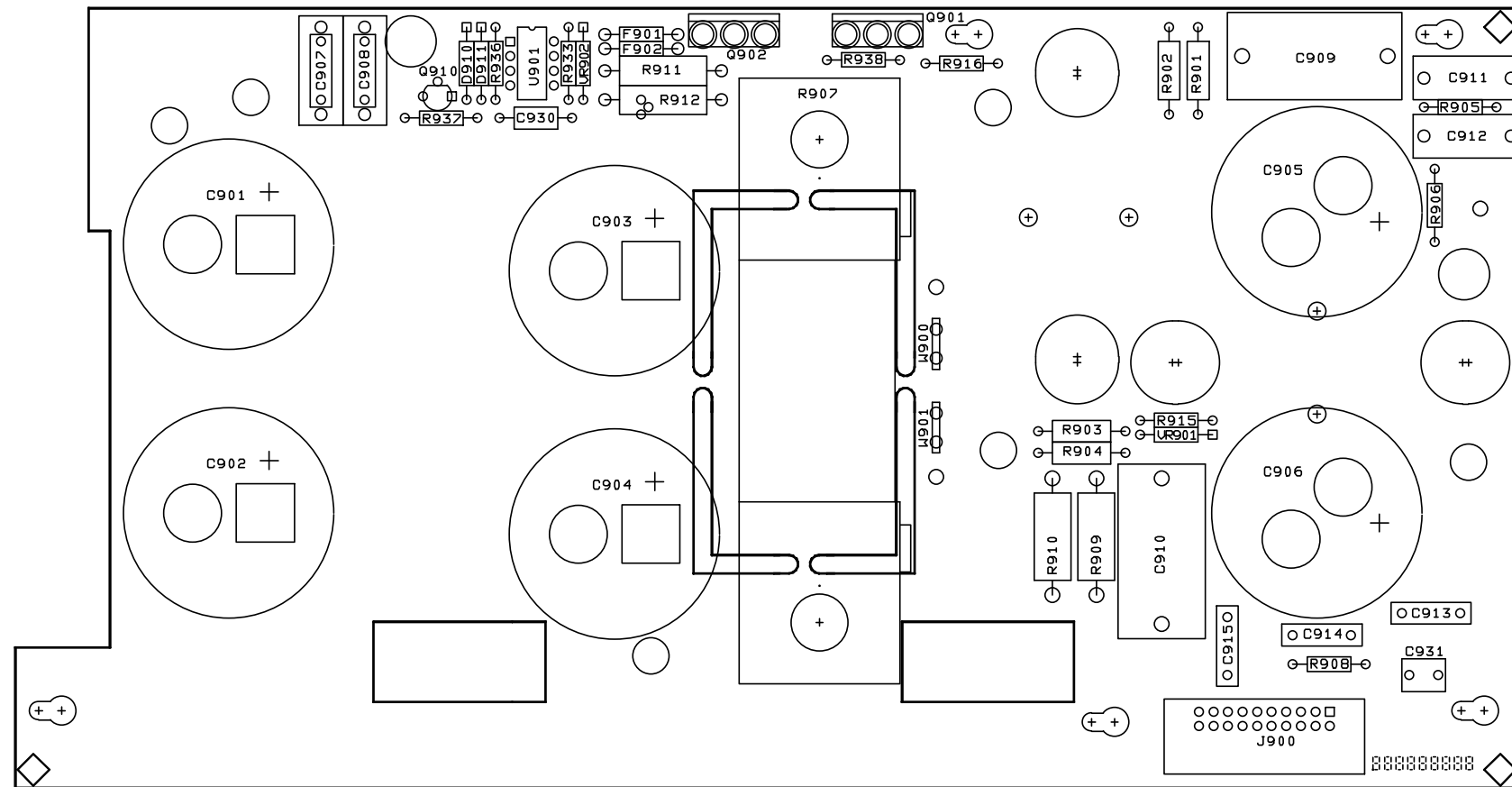

Figure 6-13. A6 Output Filter & A7 Snubber Boards Assembly Diagrams (65/6671A, 72A)

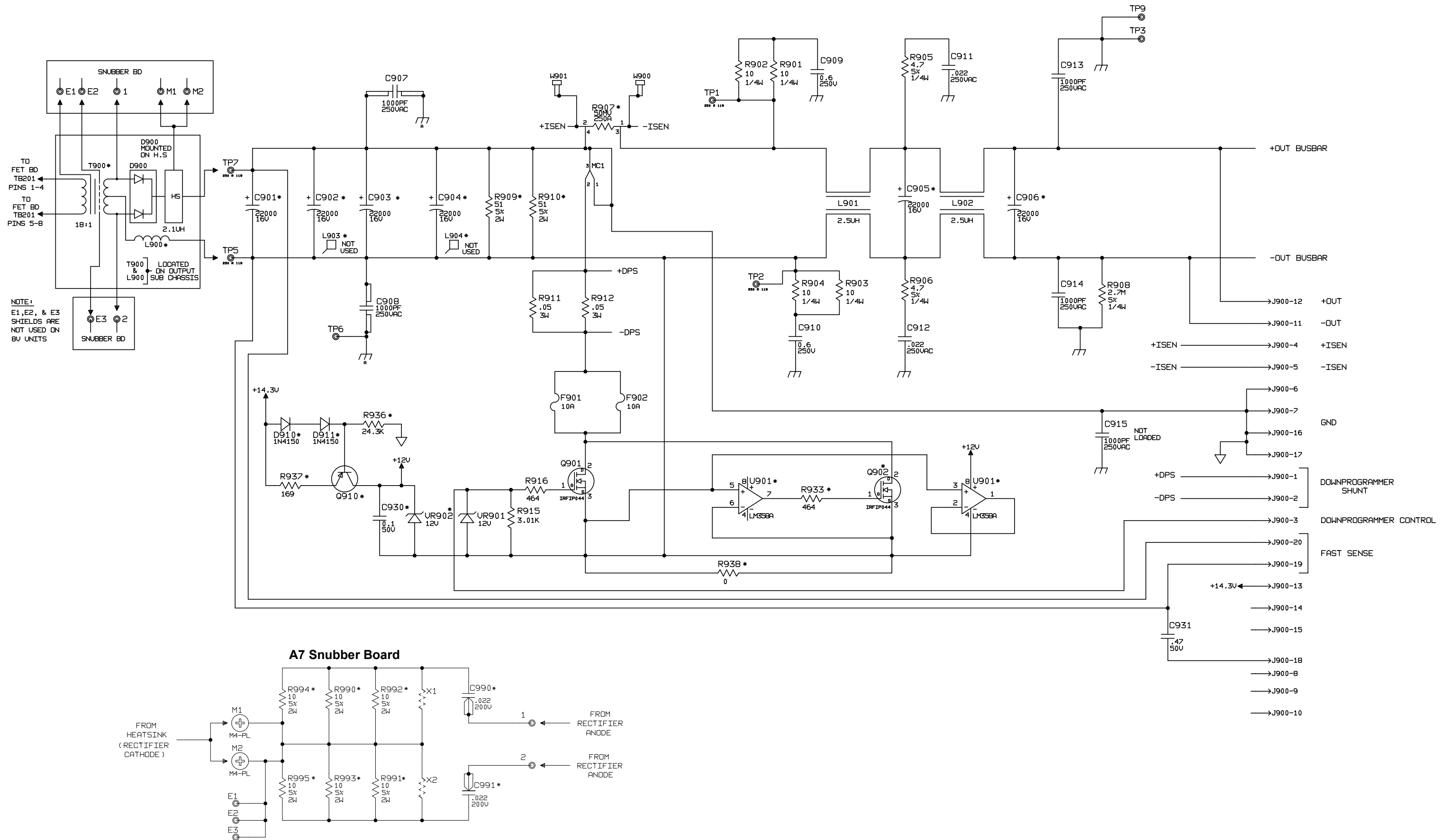

Figure 6-14. A6 Output Filter & A7 Snubber Boards Schematic Diagrams (65/6671A, 72A)

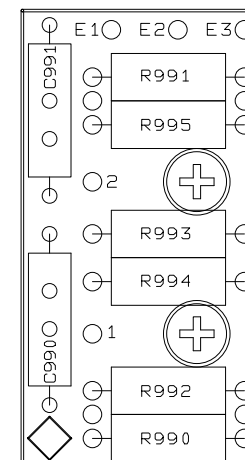
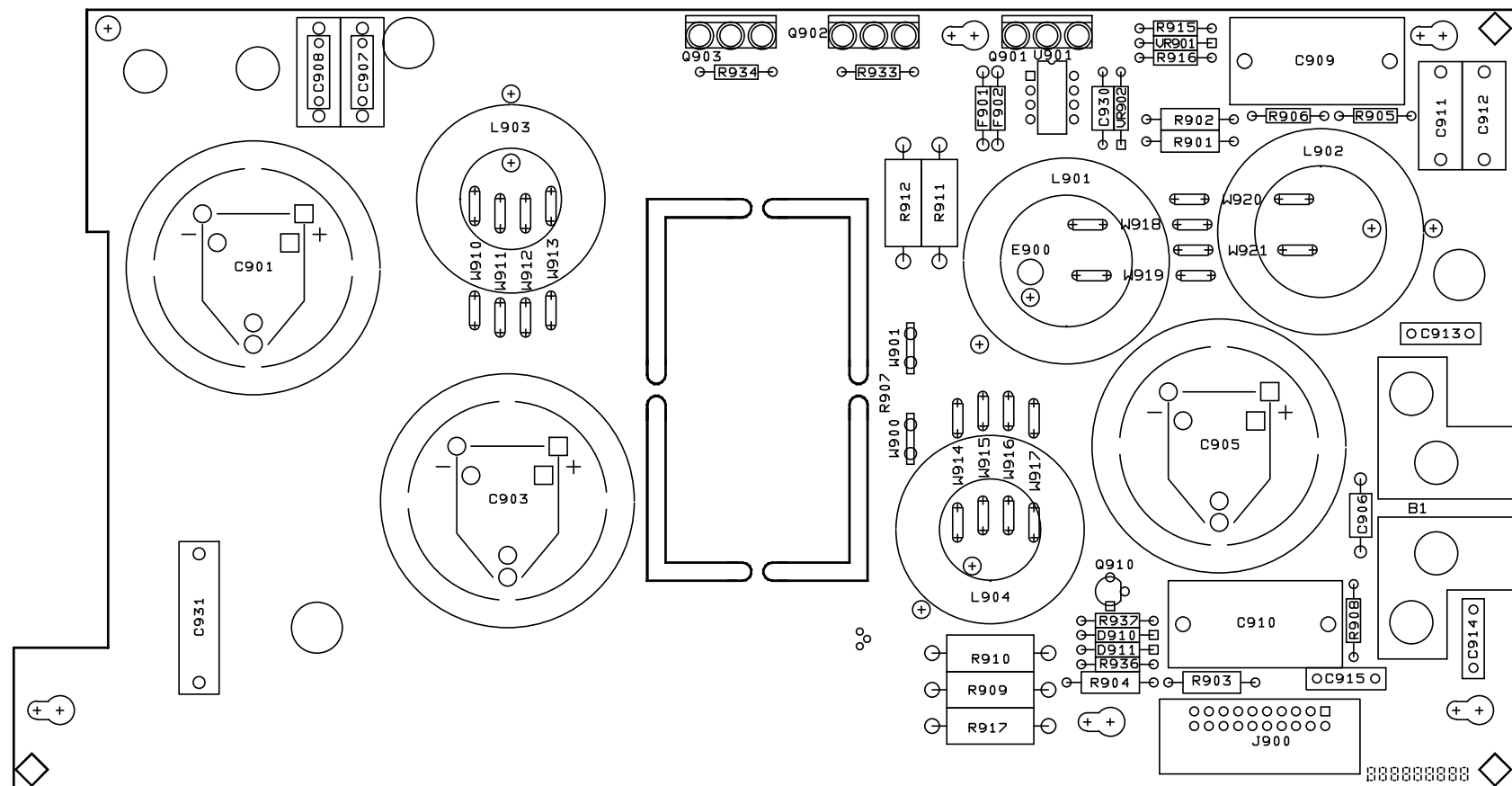

Figure 6-15. A6 Output Filter & A7 Snubber Boards Assembly Diagrams (65/6673A, 74A)

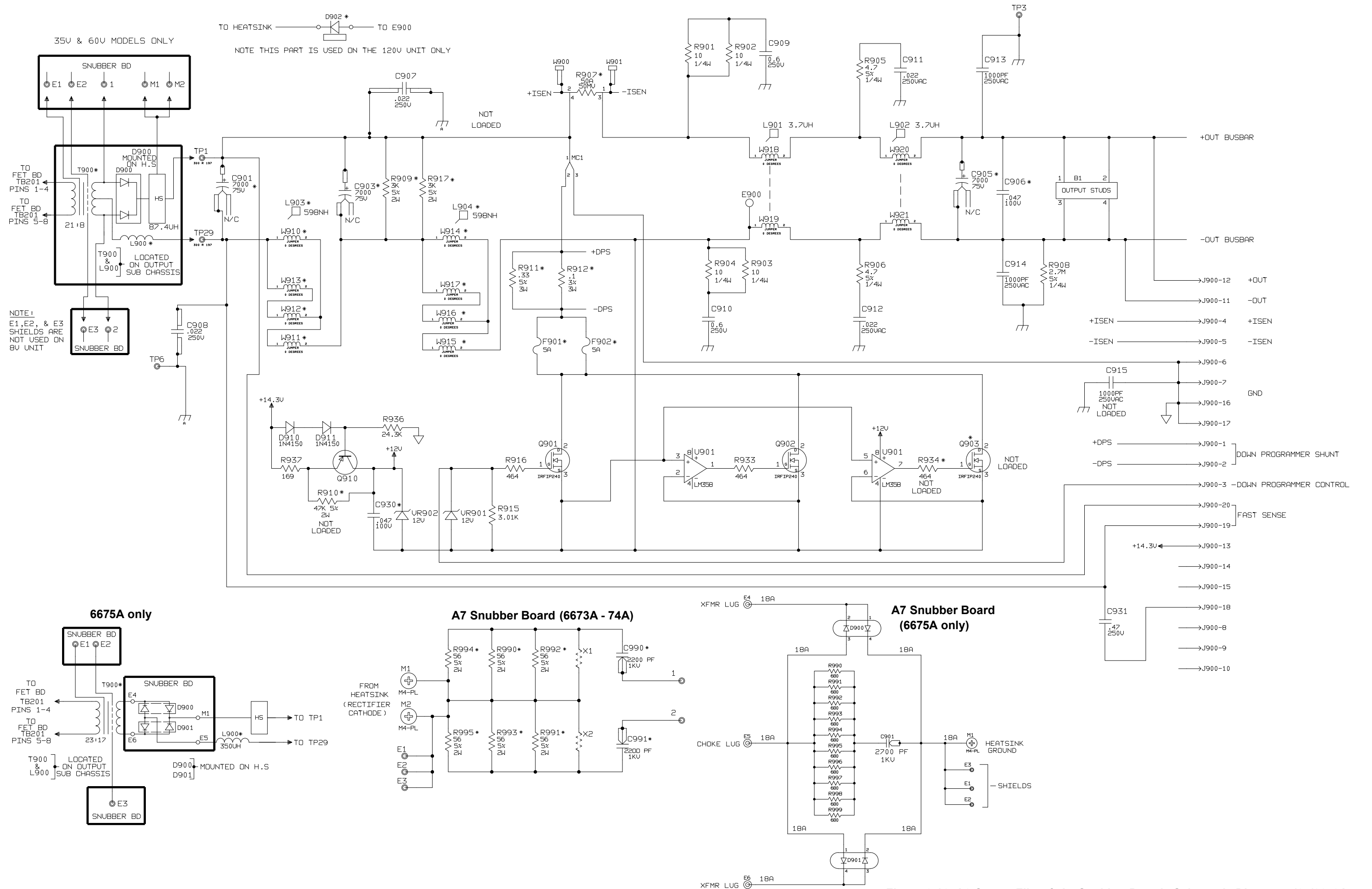

Figure 6-16. A6 Output Filter & A7 Snubber Boards Schematic Diagrams (65/6673A - 75A)

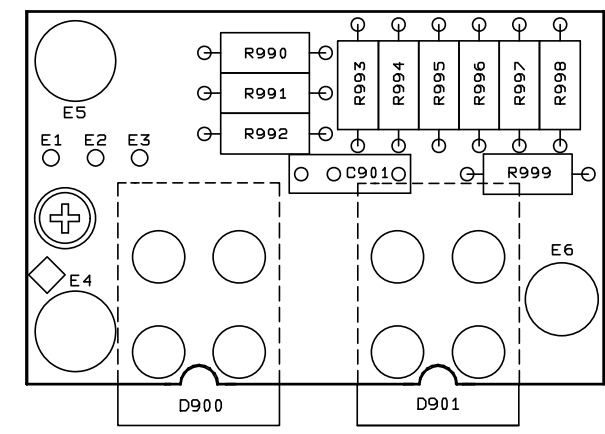
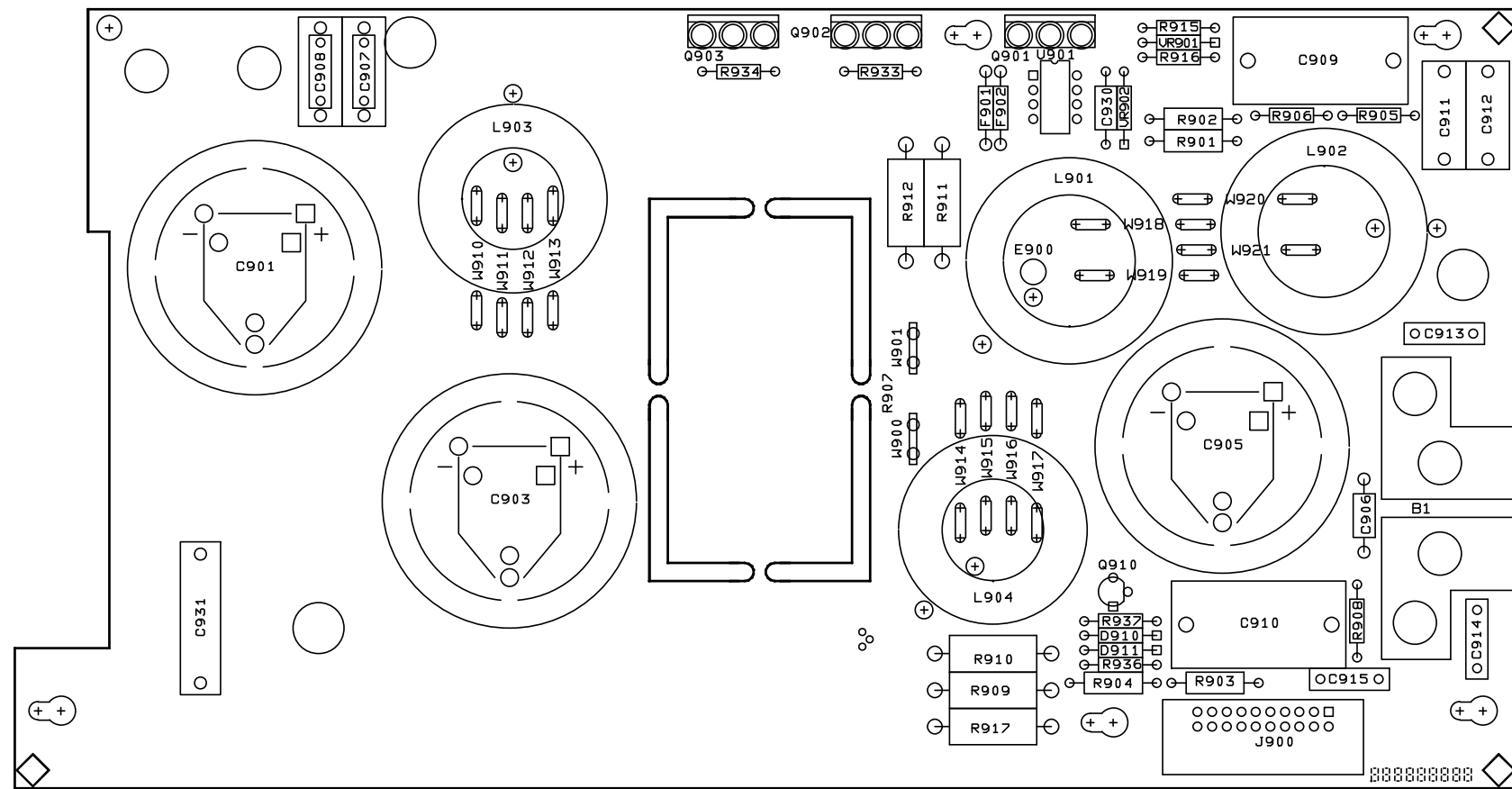

Figure 6-17. A6 Output Filter & A7 Snubber Boards Assembly Diagrams (65/6675A)

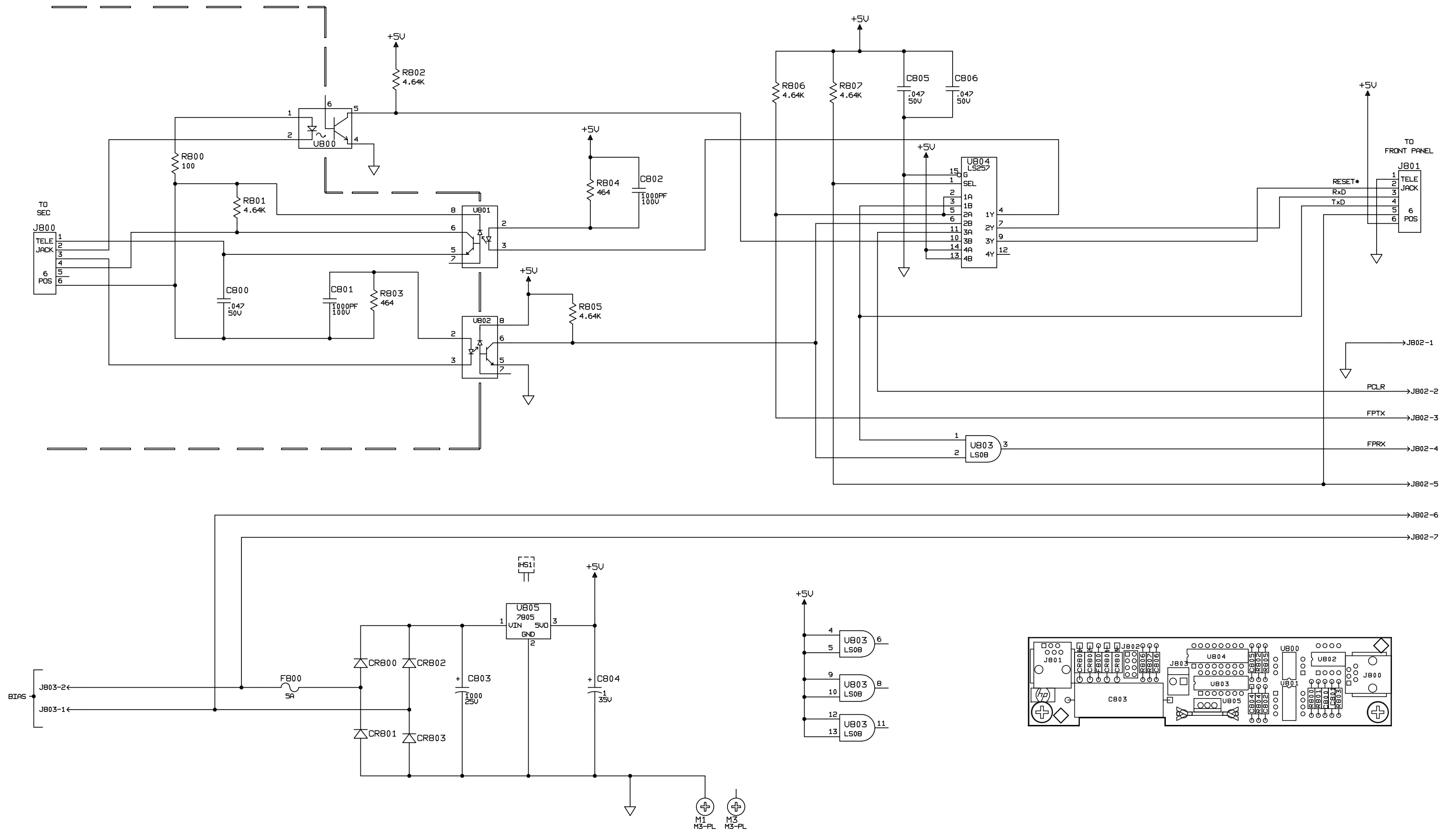

Figure 6-18. A2 Isolator Board Assembly and Schematic Diagram for 654xA & 655xA Models Only

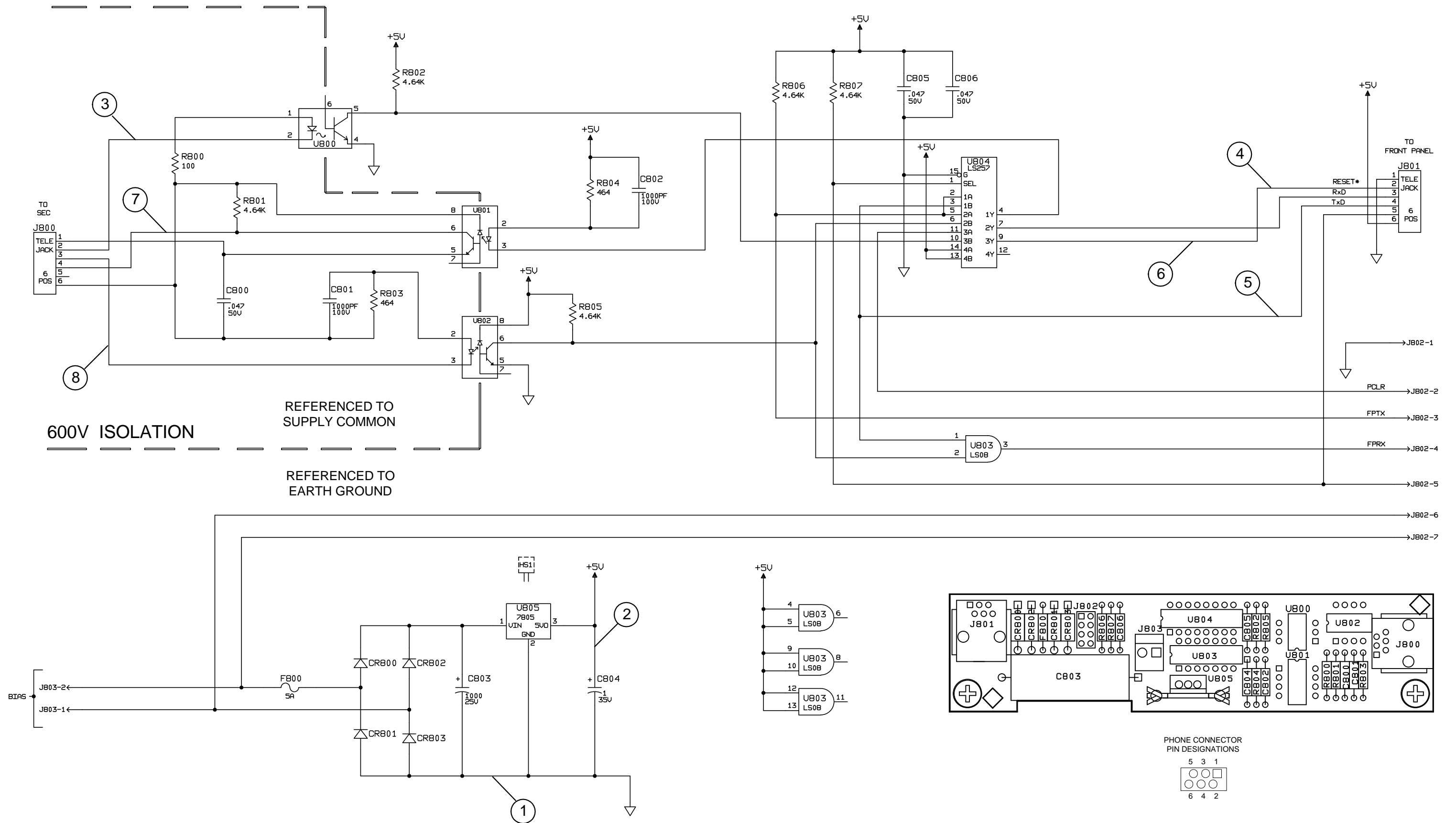

Figure 6-19. A2 Isolator Board Assembly and Schematic Diagram (667xA only)

Backdating

Manual backdating describes changes that must be made to this manual for power supplies whose serial numbers are lower than those listed in the title page to this manual.

Look in the following table and locate your Keysight Model. Then look at each serial number listed for this group. If the serial number of your power supply is **prior** to any of the serial number(s) listed, perform the change indicated in the **Change** column. Note that, several changes can apply to your supply. You may also be instructed to update your power supply if certain components are being replaced during repair.

Note: For all Keysight Models, make changes 26 through 34 and change 36.

Serial Numbers	Change
Model 6571A	
3206A 00103	8,9
3222A 00118	7
3222A 00123	14
All	17,19,22,37
3635A 00143	39,40
Model 6572A	
3203A 00103	8
3203A 00108	7,9,10,11
3216A 00123	14
3422A 00138	37
3626A 00218	39
3635A 00223	40
Model 6573A	
3204A 00103	8,9
3223A 00113	7
3223A 00133	14
3432A 00143	37
3620A 00208	38
3633A 00220	39,40
Model 6574A	
3208A 00103	6,8,9
3230A 00113	7,14
All	22
3423A 00183	37
3423A 00258	38
3620A 00303	39
3634A 00323	40

Serial Numbers	Change
Model 6575A	
3209A 00103	8,9
3220A 00108	6
3242A 00118	14
3423A 00163	37
3423A 00208	38
3622A 00238	39
3634A 00268	40
Model 6671A	
3125A 00168	1
3129A 00183	13
3145A 00233	2,3,4
3203A 00273	9
3215A 00323	7
3236A 00388	12
3236A 00428	14,35
All	17,19,20,21,22, 23,24,25,36
3624A 00578	39
3639A 00601	40
Model 6672A	
3138A 00101	13
3149A 00120	9
3217A 00131	7,10
3235A 00151	12
3235A 00201	14
3347A 00256	35
All	19,22,36
3621A 00561	39
3632A 00603	40

Serial Numbers	Change
Model 6673A	
3138A 00101	13
3151A 00116	9
3216A 00141	7
3239A 00176	12
3239A 00226	14
3345A 00356	35
All	19,22,36
3501A 00796	38
3620A 01006	39
3634A 01086	40
Model 6674A	
3126A 00131	1,13
3144A 00181	2
3146A 00191	3,5,9
3208A 00103	5
3215A 00251	7
3216A 00261	12
3216A 00331	14

Serial Numbers	Change
Model 6674A (cont)	
3346A 00391	35
All	15,16, 19,20,21, 22,23,24,25,36
3501A 00941	38
3619A 01161	39
3632A 01225	40
Model 6675A	
3138 00101	13
3149A 00116	9
3216A 00136	7
3234A 00156	12
3242A 00191	14
3350A 00221	35
All	19,22,36
3502A 00551	38
3619A 00796	39
3632A00932	40

CHANGE 1

In Table 5-9:

CHANGE: Capacitor from 100pF 5% Keysight P/N 0160-4801 to resistor zero ohm Keysight P/N 8159-0005 (Circuit Reference C506) NOTE The resistor will be inserted where the capacitor was. Wire Keysight P/N 8150-2408 is hand wired from J509 pin 16 to U502 pin 12.

In Table 5-7:

DELETE: Resistor 100 ohms 0.1% 0.125 watt Keysight P/N 0757-0401 (R383)

CHANGE 2

In Table 5-3:

CHANGE: From 5060-3422 to 5060-3367

CHANGE: From 5060-3334 to 5060-3385

CHANGE 3

In Table 5-9:

ADD:

- 1) Resistor, R550, 4.99K 1% 1/8W Keysight P/N 0698-3279, Qty. 1 (Located in C506 position).
- 2) Jumper, 26ga, Keysight P/N 8150-2408 or equivalent, Qty. 1.5inch (between C741 and R550).

DELETE: Resistor, REF C506, Zero Ohm Keysight PIN 8159-0005, Qty. 1.

CHANGE 4

In Table 5-9:

DELETE: IC Socket, 40 Pin, REF U504, Keysight P/N 1200-0552, Qty. 1.

ADD:

- 1) Resistor, R885, 2.0K 1% 1/8W Keysight P/N 0757-0283, Qty. 1.
- 2) Resistor, R862, 3.01K 1% 1/8W Keysight P/N 0757-0273, Qty. 1.
- 3) Resistor, R861, 267 Ohm 1% 1/8W Keysight P/N 0698-4446, Qty. 1.
- 4) Resistor, R713, 1 Meg 1% 1/8W Keysight P/N 0698-8827, Qty. 1.
- 5) Capacitor, C885, 0.1 μ F 50V Keysight P/N 0160-4835, Qty. 1.
- 6) Capacitor, C760, 18pF 100V Keysight P/N 0160-4788, Qty. 1.
- 7) Capacitor, C681, 0.01 μ F 100V Keysight P/N 01604832, Qty. 1.
- 8) Diode D618 Keysight P/N 1901-0880 Qty 1.

CHANGE:

- 1) Resistor, R893 from 10K 1% 1/8 Keysight PN 0757-0442 to 7.5K 1% 1/8w Keysight P/N 0757-0440 Qty 1.
- 2) Resistor, R805 from 20K 0.1% 1/8 Keysight PN 0699-0118 to 19K 0.05% 1/8w Keysight P/N 0699-3103 Qty 1.
- 3) Resistor, R809 from 16.15K 0.1% 1/8w Keysight PN 0699-0489 to 19K 0.05% 1/8w Keysight P/N 0699-3133 Qty 1.

CHANGE 5

In Table 5-9:

CHANGE: Capacitor, C684, from 2.2 μ F Keysight P/N 0160-7277 to 3.3 μ F Keysight P/N 0160-7308, Qty. 1.

DELETE: IC Socket, 40 Pin, REF U504, Keysight P/N 1200-0552 Qty 1.

ADD:

- 1) Resistor, R885, 2.0K 1% 1/8W Keysight P/N 0757-0283 Qty 1.
- 2) Resistor, R862, 3.01K 1% 1/8W Keysight P/N 0757-0273 Qty 1.
- 3) Resistor, R861, 257 Ohm 1% 1/8W Keysight P/N 0698-4446 Qty 1.
- 4) Resistor, R713. 2.7 Meg. 5% 1/4W Keysight PN 0683-2755.
- 5) Capacitor, C885, 0.1 μ F 50V Keysight P/N 0160-4835 Qty 1.
- 6) Capacitor, C760, 18pF 100V Keysight P/N 0160-4788 Qty 1.
- 7) Capacitor, C681, 4700pF 100V Keysight P/N 0160-4831 Qty 1.
- 8) Diode, D618, Keysight P/N 1901-0880, Qty. 1.

CHANGE: Resistor, R893, from 10K 1% 1/8W Keysight P/N 0757-0442 to 7.5K 1% 1/8W Keysight P/N 0757-0440, Qty. 1.

CHANGE 6

In Table 5-10:

ADD:

- 1) Capacitor, C913 & C914, 1000pF Keysight P/N 0160-4183, Qty. 2. Pin-Solder, EI-3, Keysight P/N 1251-0600, Qty. 3.
- 2) Diode, D910 & D911, Keysight P/N 1901-1098, Qty 2.
- 3) Resistor, R917, 3K 5% 2W Keysight P/N 0698-3642, Qty. 1.

DELETE:

- 1) Resistor, R935, 6.19K 1% 1/8W Keysight P/N 0757-0290, Qty 1.
- 2) Resistor, R910, 3K 5% 2W Keysight P/N 0698-3642, Qty. 1.

CHANGE:

Resistor, R937, from 1.21K 1% 1/8W Keysight P/N 0757-0274 to 169 Ohm 1% 1/8W Keysight P/N 0698-4416, Qty. 1.

CHANGE 7

In Table 5-9:

DELETE: Resistor, R550, 4.99K 1% 1/8W Keysight P/N 0698-3279, Qty. 1.

ADD: Resistor, R896, 4.99K 1% 1/8W Keysight P/N 0698-3279, Qty. 1.

CHANGE:

- 1) Zener diode VR630. from 6.2V 2% 0.4 W H/P P/N 1902-0509 to 6.19V 2% 0.4W Keysight P/N 1902-1377, Qty. 1.
- 2) Resistor, R861, from 267 Ohm 1% 1/8W Keysight P/N 0698-4446 to 499 Ohm 1% 1/8W Keysight P/N 0698-4123, Qty. 1.

ADD: Capacitor C900 100pF 5% 100V Keysight P/N 0160-4801 Qty 1.

CHANGE 8

In Table 5-4:

ADD: Core-Magnetic, Keysight P/N 9170-1497, Qty. REF FP Phone Cable (To Chassis).

CHANGE: Assembly-PCB, Keypad from Keysight P/N 5060-3427 to Keysight P/N 5060-3464, Qty. 1.

CHANGE 9

In Table 5-3:

DELETE:

CE SHIPPING LABEL Keysight PN 5080-2247 & CE INSTRUMENT LABEL Keysight P/N 5080-2248.

CHANGE 10

In Table 5-11:

CHANGE: Capacitor, C990 C991, from 0.015 μ F \pm 10% 200V Polyester/Foil Keysight P/N 0160-0194 to 0.015 μ F \pm 5% 400V Polypropylene/Foil Keysight P/N 0160-6896, Qty. 2.

CHANGE 11

Applicable to Keysight Maintenance Personnel Only.

REFERENCE PCO 21-6348 & 21-6397 This PCO is in reference to 21-6348 & 21-6397. The start serial number for Model Q572A should be as follows:

MODEL	RUN	START SERIAL
6572A	57602	3216-00108

CHANGE 12

In Table 5-6:

CHANGE:

1) Capacitor, C138, from 0.047 μ F 20% 50V Keysight P/N 0160-5422 to 0.01 μ F 10% 100V Keysight P/N 0160-4832, Qty. 1.

2) Resistor, R134, from 100 Ohm 5% 1/4W Keysight P/N 0683-1015 to 1K 5% 1/4W Keysight P/N 0683-1025, Qty. 1.

CHANGE 13

In Table 5-6:

The power supply unit will not operate with Keysight relay boxes 59510A and 59511A in the relay link communications mode.

The cover must be removed and the jumper on the GPIB assembly 50603291 must be moved as described in the operating manual to observe this operating anomaly.

CHANGE 14

In Table 5-9:

ADD: Label Keysight P/N 5080-2249 Qty. 1 (Change to ETL label).

CHANGE 15

In Table 5-9:

ADD: Capacitor, C900, 100pF 5%100V Keysight P/N 0160-4801, Qty, 1.

CHANGE 16

In Table 5-3:

CHANGE:

1) PC Board, Output/Snubber from Keysight PN 5020-2745 to Keysight P/N 5020-2774, Qty 1.

2) Output from Keysight P/N 5020-2744 to Keysight P/N 5020-2775, Qty. 1.

CHANGE 17

In Table 5-11:

CHANGE: Capacitor, C990 & C991, from 0.022 μ F \pm 10% 200V Polyester/Foil Keysight P/N 0160-0162 to 0.022 μ F \pm 5% 400V Polypropylene/Foil Keysight P/N 0160-5927 Qty. 2

CHANGE 18

In Table 5-9:

CHANGE: Insulator, REF Y501, from 43300145 Bead, Qty. 2 to 0340-1277 Insulator Component, Qty 1.

CHANGE 19

In Table 5-3:

ADD:

Service Manual Keysight P/N 5959-3384, Qty. 1.

FOR MODEL/OPTION 6672A#910.

FOR MODEL/OPTION 6673A#910.

FOR MODEL/OPTION 6675A#910.

CHANGE:

For MODEL/OPTION 6672A#910.

For MODEL/OPTION 6671A#910.

For MODEL/OPTION 6674A#910.

Service Manual from Keysight P/N 5959-3337 to Keysight P/N 5959-3384, Qty. 1.

CHANGE 20

In Table 5-3:

CHANGE: Operating Manual from Keysight P/N 5959-3352 TO Keysight P/N 5959-3372, Qty. 1.

CHANGE 21

In Table 5-3:

CHANGE:

Line Cord, 12ga. WCSA without plug from Option 931 to Option 831.

Line Cord, 4mm Harmonized without plug from Option 932 to Option 832.

Line cord, 10ga. Canadian without plug from Option 934 to Option 834.

Line Cord, 12ga. UL/CSA with NEMA 6-20p plug from Option 941 to Option 841. Line Cord, 4mm Harmonized with IEC 309 plug from Option 942 to Option 842.

Line Cord, 12ga. Japanese with JIS C8303 plug from Option 943 to Option 843.

Line Cord, 10ga. Canadian with NEMA 6- 30P plug from Option 944 to Option 844.

Line cord family drawing C-8120-9296-1B from Rev. B to Rev. C .

CHANGE 22

In Table 5-11:

CHANGE:

Capacitor Metalized Polyester Dielectric from 1.0 μ F 20% Keysight P/N 0160-4962 to 1.0 μ F Keysight P/N 0160-7606 Qty. 1.

(Circuit Ref."C452, C30, C33, C1, C5, C133, C137, C5, C8, C9 ,C500-C502, C420, C421, C423, C497, C498").

CHANGE 23

In Table 5-10:

CHANGE: Q201-204, 211, 222, 233, 244 from POWER FET Keysight P/N 1855-0849, Qty. 8 to FET-MACHED Set Keysight P/N 5080-2241 QTY 1.

CHANGE 24

In Table 5-6:

CHANGE: Diode-Zener. VR102, FROM 11V 2% Keysight P/N 1902-3172 to 11V 5% Keysight P/N 1902-0959 Qty, 1.

CHANGE 25

In Table 5-9:

CHANGE: Microprocessor, U504, from Programmed Keysight P/N 5080-2155 to Masked Keysight P/N 1820-8600, Qty. 1.

CHANGE 26

In Table 5-9:

ADD: Label-Fuse warning Keysight P/N 7120-4827, Qty 1 (For 6002A only- Qty. 2).

CHANGE 27

In Table 5-9:

CHANGE: Thermistor, 10K @25C, Reference Designator 0837-0397 to Keysight P/N 0837-0412, Qty 1.

CHANGE 28

In Table 5-11:

CHANGE: Microprocessor, U504, from programmed (Fabricated) Keysight P/N 1820-5996 to Mask (Purchased) Keysight P/N 1821-0223 Qty. 1.

CHANGE 29

In Table 5-11:

CHANGE:

- 1) Microprocessor, Masked U504, from Keysight P/N 1821-0223 to Keysight P/N 1821-0943, Qty. 1.
- 2) Firmware, Secondary, from Rev. A101.03 to Rev. A.01.05.
- 3) READ-ONLY MEMORY FRONT PANEL 5080-2208.

CHANGE 30

In Table 5-11:

CHANGE: ROM, Front Panel, U4, Firmware from Rev. A.01.07 to Rev. A.01.08.

CHANGE 31

In Table 5-7:

CHANGE:

- 1) Heat sink, Ref D400, from Keysight P/N 12050766 to Keysight P/N 1205-0861, Qty 1.
- 2) Heat sink, Ref D400, from Keysight P/N 1205-0766 to Keysight P/N 1205-0861, Qty 1.

CHANGE 32

In Table 5-3:

CHANGE: Fuseholder 'Clip Type' from Keysight P/N 2110-0269 to Keysight P/N 2110-0726 QTY 2.

CHANGE 33

In Table 5-4:

CHANGE: IC Read-Only Memory, U4, Keysight P/N 5080-2208 from Fabricated To Purchased.

CHANGE 34

In Table 5-3:

ADD: Collar RPG P/N 5040-1700 Qty. 2.

CHANGE 35

In Table 5-3:

CHANGE: Part number of the A2 GPIB board from P/N 5060-3399 to P/N 5060-3291.

In Table 5-6:

REPLACE: Table 5-6 (A2 GPIB Board Parts List) in Section 5 of this manual with the A2 GPIB Board Parts List shown in Table A-1 in the next page.

REPLACE: A2 GPIB Board Component Location diagram in Section 6 of this manual with the A2 GPIB Board Component Location Diagram shown in Figure A-1 at the end of this appendix.

CHANGE 36

In Figure 3-18, sheet 1 on page 72: Change first data value on program line 360 from 1296 to 1304.

In Table 5-3 on page 91: A2 GPIB board to 5060-3399.

In Table 5-3 on page 92: Change DSP1 to 5061-1190

In schematic, Figure 6-14: Add D910, D911, R910 and VR902 to the down programming circuit. This section of the circuit should match Figure 6-16. These components are model dependent.

In Table 5-6 on page 98: Change the part number of U121 to 1820-0430.

CHANGE 37

In Table 5-5 on page 97: Change F800 to 5A normal blow, part number 2110-0669.

CHANGE 38

In Table 5-10 on page 118: Change Q901, 902 and 903 to part number 1855-0835.

CHANGE 39

In Table 5-3 on page 91: Change A1 Front panel board for 667xA Series to part number 5060-3400.

In Table 5-3 on page 92: Change G1 and G2 to part number 0960-0822.

In Table 5-3 on page 93: Change Knob (for G1 and G2) to part number 0370-1091.

In Table 5-4 on page 96: Change U4 to part number 5080-2208.

CHANGE 40

In Table 5-9 on page 106 and on schematic Figure 6-12: Delete C691 and 692

Index

A

A1 Front Panel Board, test header	61
A2 GPIB Board, test header	61
A3 FET Board	
dynamic troubleshooting	58
static troubleshooting	57
test connections	57
test points	57,58
analog port.....	11

B

bias supply.....	36
------------------	----

C

cable	
W3 ribbon	75
W4 phone	75
W5 phone	75
W6 ac bias	74
Cabling diagram	127
calibration constants, factory	67
calibration password.....	67
calibration, post-repair.....	67
calibration procedure	11
CC annunciator	57
CC load effect, testing	24
CC noise (PARD), testing	24
CC PARD, defined	24
Circuits	
isolator board.....	82
conductive table mat.....	13
conductive wrist strap.....	13
configuration jumper	
FACTORY PRESET CAL.....	61
FLT/INH	61
INHIBIT CAL.....	61
RELAY LINK.....	61
SA mode.....	61
current, maximum programmable.....	17
current, -CC.....	17
current programming and readback accuracy.....	18
current sink and readback accuracy, testing	2-8
CV/CC status annunciators.....	23
CV load effect, defined.....	21
CV load effect, testing	21
CV noise (PARD), defined.....	21
CV noise (PARD), testing	21

CV source effect. defined	21
CV source effect, testing	20
CV transient response waveform	22
CV transient recovery time, defined	22
CV transient recovery time, testing	22
CV voltage programming and readback accuracy, testing.....	20

D

Diagram cabling	131
DIG CNTL port, configuring.....	61
disassembly procedures	73
downprogrammer FETs, location of.....	75

E

electronic load	16, 23
error, checksum	35
error code	
E1	35
E10	35
E11	35
E12	35
E2	35
E3	35
E4	35
E5	35
E6	35
E7	35
E8	35
E9	35
error code, over GPIB	34
error code, selftest	35
error message	
CAL DENIED	67
DACS	35
EE CHKSM.....	35
EE WRITE ERR	35
FP RAM	35
FP ROM	35
FRAMING	35
GPIB	35
PASSWD ERROR	67
PRI IRAM	35
PRI ROM	35
PRI XRAM.....	35
SBUF FULL.....	35
SBUF OVERRUN.....	35
SEC 5V	35
SECONDARY DWN	35
SEC RAM	35
SEC ROM	35
SERIAL DOWN	35

SERIAL TIMEOUT	35
TEMP	35
UART OVERRUN.....	35
UART PARITY	35
error message, selftest	35
errors	
calibration.....	36
selftest	36
ESD, 1-2, 3-1	

F

factory calibration constants	67
firmware, revisions	12
firmware revisions	60
Form, performance test record.....	27
front panel EEPROM	
factory cal location	68
initialization of	68
transferring constants to	68
front panel operation	11
front panel, testing.....	34

G

GPIB error 2.....	67
GPIB interface, testing	34

I

*IDN query.....	60
inhibit calibration jumper	67
Isolator board circuits.....	82

J

jumper	
DIG I/O	61
FACTORY PRESET CAL.....	61
INHIBIT CAL.....	61
NORM.....	61

K

keypad	17
Keysight 50504A oscilloscope	34
Keysight 545A logic probe.....	34

L

line fuse, replacing.....	11
line voltage, conversion of.....	11

M

manual backdating.....	12
manual changes sheet	12, 13
manufacturing date, determining	12
message	
PWR ON INIT	34, 67
Mnemonics	
signal names	124
mutual coupling, test lead	17

N

noise, testing,.....	15
----------------------	----

O

operating manual	11
oscilloscope, Keysight 54504A	16
output heatsink assembly	75
output rectifiers	
location of	75
replacing	76
overvoltage, maximum programmable	17

P

Performance test record form	27
performance tests, CC	23
performance tests, CV	20
power FETs, replacing	121, 122
power-on selftest	34
power-on selftest, disabling	34
protective earth ground.....	13

R

record sheet, test	17
reference supply	37
regulation, voltage	18
removing	
A1 Front Panel Assembly.....	74
A1 Front Panel Board.....	74
A2 GPIB Board.....	75
A3 FET Board.....	77
A4 AC Input Board	78
A5 Control Board.....	76
A6 output Filter Board	76
A7 Snubber Board.....	76
ac input filter	78
fan.....	77
heatsink assembly.....	75
keypad	76
L900 output choke.....	76
line switch	74

output subchassis	75
rear panel	75
RFI shield	73
RPG controls	74
T900 output transformer	76
top cover	73
Replaceable parts	
for A2 isolator board	97
resistor	
current monitoring	16
load	16
resistor, current monitor	23
resistor, current monitoring	24

S

SA	60
SA secondary interface, exiting test	66
SA signals	
A5 microprocessor	66
SA signals, secondary interface	66
SA signatures, identical	60
SA signatures, similar	60
SA test header jumper	61
Schematic notes	129
SCPI programming	11
secondary interface, testing	34
sense terminals	17
serial number	12
serial number prefix	12
settling time	17
Signal name	
mnemonics	124
Signals	
+5 V bias voltage	84
BSTx	84
PCLR	84
RESET*	84
RxD	84
SPCLR*	84
Srx	84
TxD	84
XFMR T1	84
slew rate	17

T

test	
selftest	15
test equipment, troubleshooting	34
test headers	60
test leads	17
test measurements, cc mode	23
test points, troubleshooting	61
Test point waveforms	130

tests	
constant-current mode	19
constant-voltage mode.....	19
independent order of	19
operation verification	15
performance.....	15
programming	15
Tests	
performance test record	27
TORX screws	72
transformer, variable-voltage.....	16
transient recovery time	16
Troubleshooting test points	125
troubleshooting chart	
output held high.....	47
ov at turn-on	43
secondary downprogramming	56
troubleshooting charts	37
*TST?.....	34
*TST? query	34

U

UNREGULATED annunciator.....	57
using *IDN query	12

V

voltage, maximum programmable	17
-------------------------------------	----

GYf]U`Bi a VYfg

For instruments with Serial Numbers:

Keysight Model 6571A: US36520101 and Above *
Keysight Model 6572A: US36350101 and Above *
Keysight Model 6573A: US36330101 and Above *
Keysight Model 6574A: US36340101 and Above *
Keysight Model 6575A: US36340101 and Above *

Keysight Model 6671A: US36400101 and Above *
Keysight Model 6672A: US36390101 and Above *
Keysight Model 6673A: US36380101 and Above *
Keysight Model 6674A: US36370101 and Above *
Keysight Model 6675A: US36370101 and Above *

* For instruments with higher serial numbers, a change page may be included.
For instruments with lower serial numbers, see Appendix A.



This information is subject to change without notice.
© Keysight Technologies 1993, 2000, 2014
Edition 3, December 2014



5961-2583

www.keysight.com